



SUBMERSIBLE PUMPS & MOTORS

QF SERIES (50 Hz)



CONTENT PAGE NO.

GENERAL DATA

Performance Range..... 1
 Pump Range..... 2
 Motor Range..... 2
 Applications..... 3
 Type Key..... 3
 Pumped Liquids..... 3
 Operating Conditions..... 3
 Curve Conditions..... 3

SUBMERSIBLE PUMPS

Features and Benefits..... 4-6
 Material Specification..... 7

SUBMERSIBLE MOTORS

Features and Benefits..... 8-9
Material Specification & Sectional View
 3" MOTOR 10
 4" PREMIUM 100, 4" PREMIUM 101 11-12
 4" MCIP 100, 4" MCIP 101..... 13-14
 6" MTSF..... 16
 6" SML..... 17
 8" MTSF..... 18
 10" MTSF..... 19
 12" MTSF..... 20

PERFORMANCE CURVES / TECHNICAL DATA OF SUBMERSIBLE PUMPS

Q3 21-22
 QF1..... 23-24
 QF2..... 25-26
 QF5..... 27-28
 QF6..... 29-30
 QF8..... 31-32
 NGP12..... 33-34
 QF12..... 35-36
 QF20..... 37-38
 QF25..... 39-40
 QF10..... 41-44
 QF15..... 45-48
 QF30..... 49-54
 QF50..... 55-60
 QF60..... 61-63
 QF75..... 64-69
 QF100..... 70-75
 QF150..... 76-77
 QF125..... 78-83
 QF160..... 84-89
 QF210..... 90-95
 QF270..... 96-101
 QF360..... 102-107

CONTENT PAGE NO.

V14 PUMPS

SSP General Data..... 108
 Pump Range..... 109
 Motor Range..... 109
 Type Key..... 109
 Pumped Liquids..... 109
 Operating Conditions..... 109
 Features & Benefits..... 110
 Performance Range 111
 Material Specification &
 Sectional view of SSP 270..... 112
Performance Curve & Technical Data
 SSP 270..... 113-116
 SSP 300..... 117-120
 SSP 360..... 121-124

SUBMERSIBLE MOTORS

Single Phase Performance Data 50 Hz
 4" Premium 100/101..... 125
 Three Phase Performance Data 50 Hz
 4" Premium 100/101..... 126
 MTSF 6" Rewindable Motors
 Performance Data 50 Hz..... 127
 MTSF 8" Rewindable Motors
 Performance Data 50 Hz..... 128
 MTSF 10" Rewindable Motors
 Performance Data 50 Hz..... 129
 MTSF 12" Rewindable Motors
 Performance Data 50 Hz..... 130

TABLE OF HEAD LOSSES

Connecting Pieces..... 131
 Head Losses in Ordinary Water Pipes..... 132
 Head Losses in Plastic Pipes..... 133

CABLE SIZING

Submersible pumps SP A, SP..... 134-135
 Zinc Anodes..... 136

GENERAL DATA



PERFORMANCE RANGE

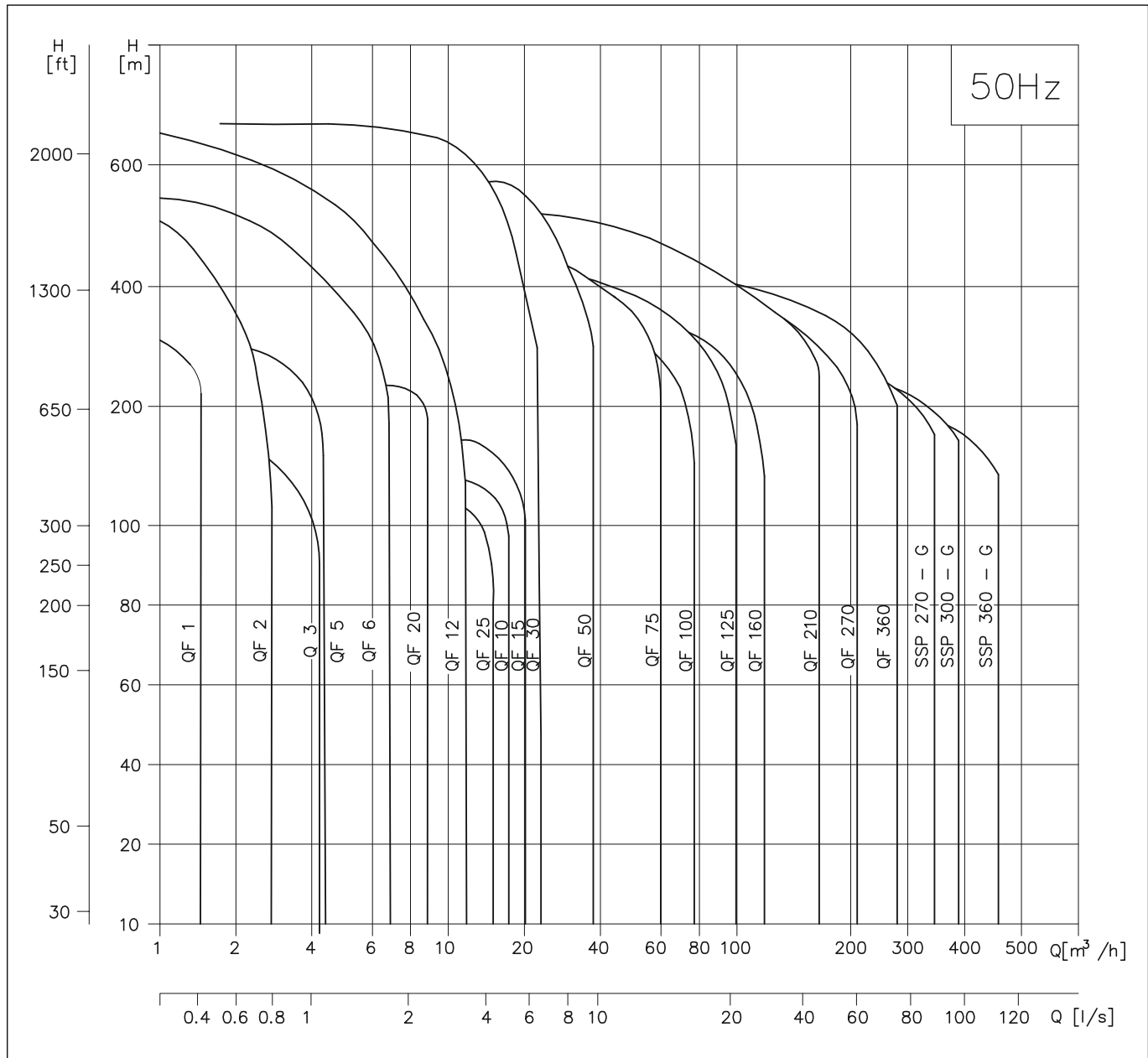

GENERAL DATA



PUMP RANGE

Type	Q3	QF1	QF2	QF5	QF6	QF12	QF20	QF25	QF10	QF15	QF30	QF50	QF75	QF100	QF125	QF150	QF160	QF210	QF270	QF360
Steel: AISI SS 304	+	+	+	+	+	+	+	+	+	+	+	+	+	+	+		+	+	+	+
Connection : Rp (Inches)																				
BSP Thread	1 ^{1/4}	1 ^{1/4}	1 ^{1/4}	1 ^{1/4}	1 ^{1/2}	2	2	2	2	2	2 ^{1/2}	3	3 4	3 4	5	4	5	6	6	6
NPT Thread	1 ^{1/4}	1 ^{1/4}	1 ^{1/4}	1 ^{1/4}	1 ^{1/2}	2	2	2	2	2	3	3	3 4	3 4	5	4	5	6	6	6
Flange Connection															5"		5"	6"	6"	6"

MOTOR RANGE

MOTOR OUTPUT [KW]	0.37	0.55	0.75	1.1	1.5	2.2	3.0	4.0	5.5	7.5	9.2	11	13	15	18.5	22	26	30	37	45	55	75	93	110	132	147	170	190	220	
Single Phase	+	+	+	+	+	+	+	+																						
Three Phase	+	+	+	+	+	+	+	+	+	+	+	+	+	+	+	+	+	+	+	+	+	+	+	+	+	+	+	+	+	+
Rewindable Motor	+	+	+	+	+	+	+	+	+	+	+	+	+	+	+	+	+	+	+	+	+	+	+	+	+	+	+	+	+	+
Steel : AISI 304	+	+	+	+	+	+	+	+	+	+	+	+	+	+	+	+	+	+	+	+	+									
Steel : AISI 304 & Cast Iron	+	+	+	+	+	+	+	+	+	+	+	+	+	+	+	+	+	+	+	+	+	+	+	+	+	+	+	+	+	+

Encapsulated motor 0.37 kW to 45 kW

Direct-on-Line starting is recommended up to 7.5 kW.

Soft starter or auto transformer is recommended above 7.5 kW.

GENERAL DATA

APPLICATIONS

The pumps are suitable for the following applications :

- Raw water supply
- Irrigation systems
- Groundwater lowering
- Pressure boosting
- Industrial applications

TYPE KEY

Example

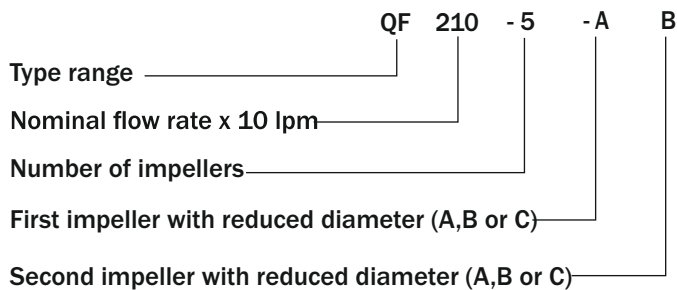

PUMPED LIQUIDS

Clean, thin, non-aggressive liquids without solid particles or fibres.

OPERATING CONDITIONS

Flow rate, Q : 0.1 - 280 m³/h.

Head, H: Maximum 670m.

Maximum Liquid Temperature:

Motor	Installation		
	Flow velocity-past motor	Vertical	Horizontal
Shakti 3",4",6" & 8"	0.15 m/s	40°C	40°C

Operating pressure: Maximum 0.67m (67 bar)

CURVE CONDITIONS

The conditions below apply to the curves shown on the following pages :

GENERAL

- Curve tolerance according to ISO 9906, Annex A.

- The performance curves show pump performance at actual speed cf. standard motor range.

The speed of the motors is approximately :

3" motors : n=2850 min⁻¹

4" motors : n=2870 min⁻¹

6" motors : n=2870 min⁻¹

8" to 12" motors : n=2900 min⁻¹

- The measurements were made with airless water at a temperature of 20°C. The curves apply to a kinematic viscosity of 1mm²/s. When pumping liquids with a density higher than that of water, motors with correspondingly higher outputs must be used.
- The bold curves indicate the recommended performance range.
- The performance curves are inclusive of possible losses such as non-return valve loss.

Q-3, QF1, QF2, QF5, QF6, QF12, QF20, QF25 CURVE

- **Q/H** : The curves are inclusive of valve and inlet losses at the actual speed.
- **Power Curve** : BPkW/Stage shows pump power input per stage.
- **Efficiency Curve** : Efficiency shows pump stage efficiency.

QF10, QF15, QF30, QF50, QF75, QF100, QF125, QF160, QF210, QF270, QF360 CURVE

- **Q/H** : The curves are inclusive of valve and inlet losses at the actual speed.
Operation without non-return valve will increase the actual head at nominal performance by 0.5 to 1.0 m.
- **NPSH** The curve is inclusive of suction case and shows required inlet pressure.
- **Power Curve**: It shows pump power input at the actual speed for each individual pump size.
- **Efficiency Curve** : Efficiency shows pump stage efficiency.

SUBMERSIBLE PUMPS

FEATURES AND BENEFITS

A WIDE PUMP RANGE

We offers submersible pumps with energy efficient duty points ranging from 0.1 to 335 m³/h. The pump range consists of many pump sizes and each pump size is available with an optional number of stages to match any duty point.

HIGH PUMPS EFFICIENCY

Often pump efficiency is a neglected factor compared to the price however, the observant user will notice that price variations are without importance to water supply economics compared to the importance of pump and motor efficiencies.

EXAMPLE:

When pumping 125 m³/h with a head of 200m for a period of 10 years \$ 60,000 will be saved if a pumps and motors having a 10% higher efficiency is chosen and the price is \$ 0.10 per kWh.

APPLICATIONS

We offers a complete range of pumps and motors which as a standard are made completely of stainless steel AISI - 304. This provides for good wear resistance and a reduced risk of corrosion when pumping ordinary cold water with a minor content of chloride.

LOW INSTALLATION COSTS

Stainless steel means low weight facilitating the handling of pumps and resulting in low equipment costs and reduced installation and service time. In addition pumps will be as new after service due to the high wear resistance of stainless steel.

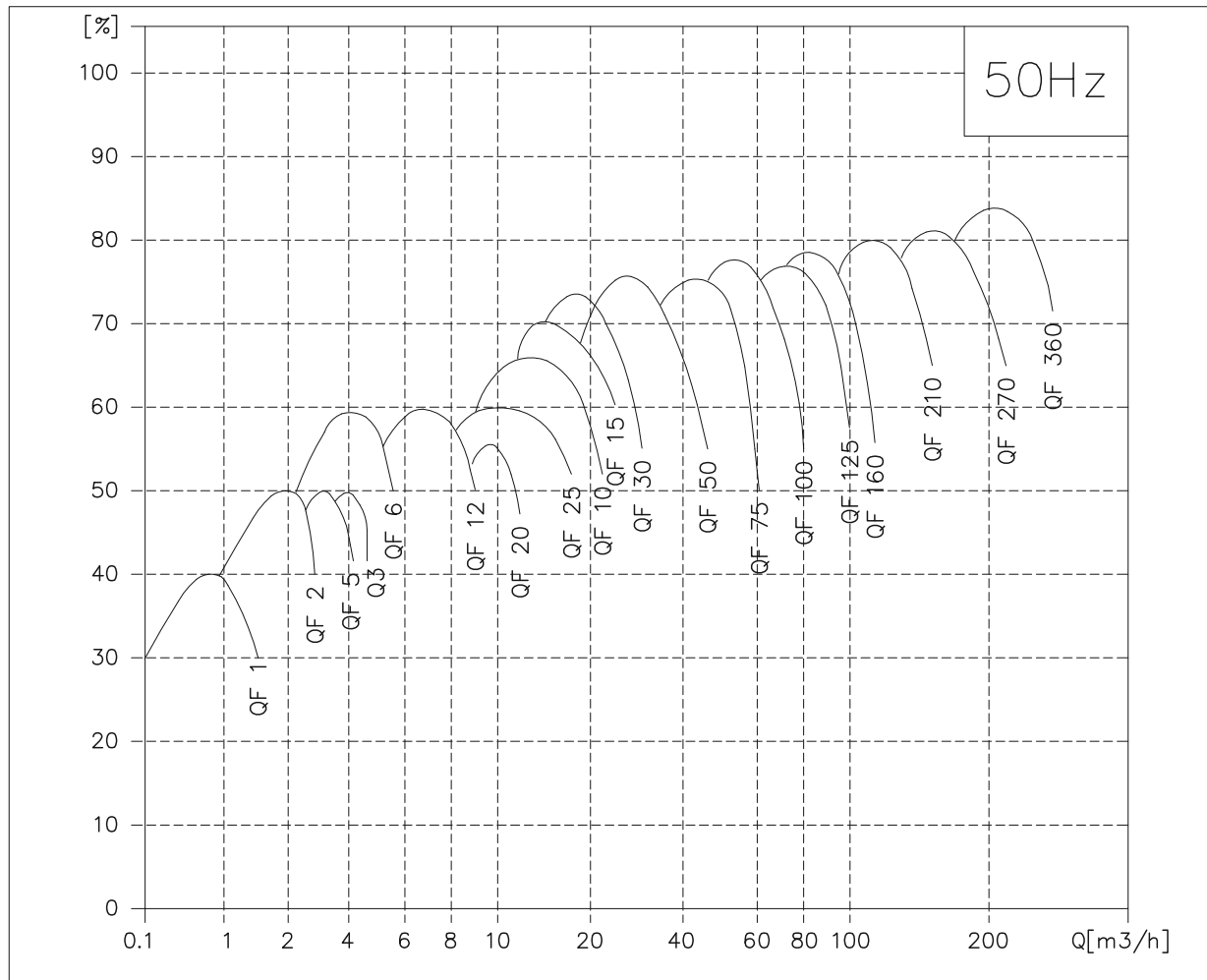

SUBMERSIBLE PUMPS

BEARINGS WITH SAND CHANNELS

All bearings are water-lubricated and have a square shape, enabling sand particles, if any, to leave the pump together with the pumped liquid.

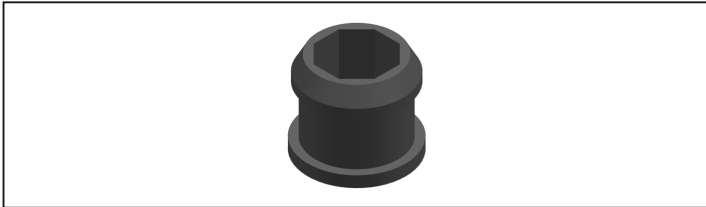

INLET STRAINER

The inlet strainer prevents particles over a certain size from entering the pump.

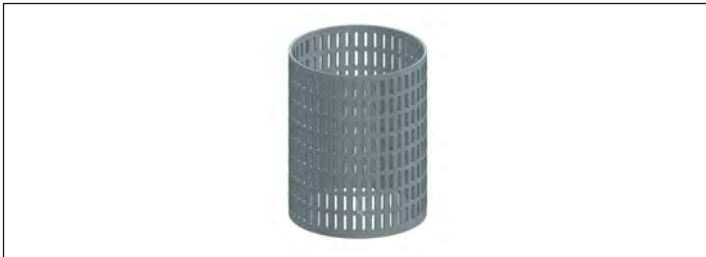

NON - RETURN VALVE

All pumps are equipped with a reliable non-return valve in the valve casing preventing back flow in connection with pump stoppage. Furthermore, the short closing time of the non-return valve means that the risk of destructive water hammer is reduced to a minimum. The valve casing is designed for optimum hydraulic properties to minimize the pressure loss across the valve and thus contributes to the high efficiency of the pump.

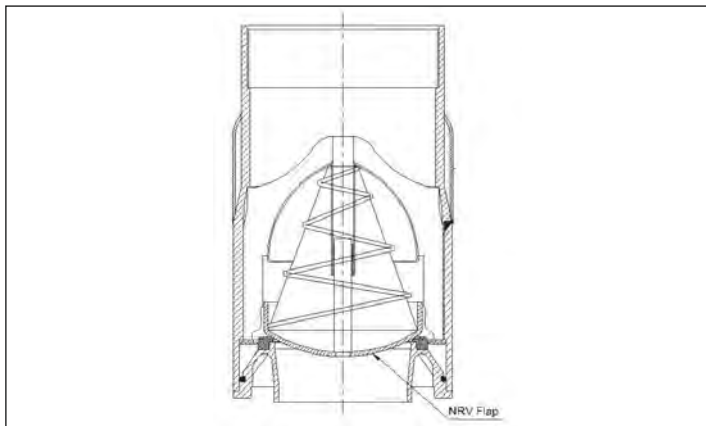

SUBMERSIBLE PUMPS

PRIMING SCREW

All QF and QF 30 pumps are fitted with a priming screw. Consequently, dry running is prevented because the priming screw will make sure that pump bearing are always lubricated. Due to the semi-axial impellers of large QF pumps (except for QF 30) this priming is automatically provided. However, it applies to all pump types that if the water table is lowered to a level below the pump inlet neither pump nor motor will be protected against dry running.

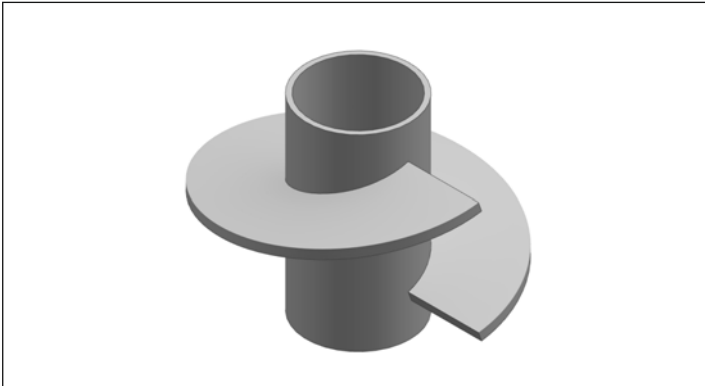

STOP RING

The stop ring prevents damage to the pump during transport and in case of up-thrust in connection with start-up. The stop ring, which is designed as a thrust bearing limits axial movements of the pump shaft.

EXAMPLE : QF 125

The stationary part of the stop ring (A) is secured in the top bowl (Upper intermediate chamber). The rotating part (B) is fitted above the collet [split cone (C)].

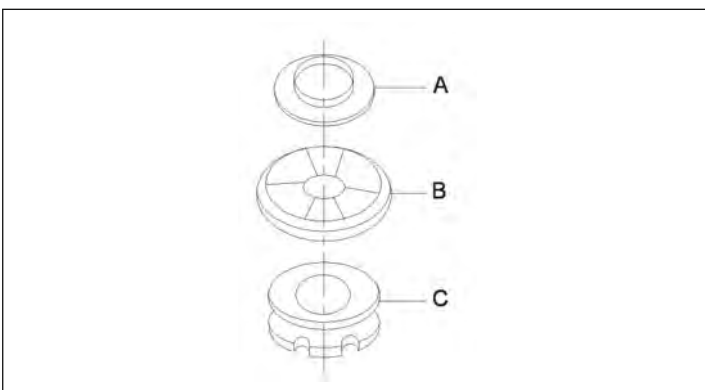

SUBMERSIBLE PUMPS



MATERIAL SPECIFICATION

EXAMPLE : QF - 125

POS.	DESCRIPTION	MATERIAL	STANDARD	N-VERSION
1	VALVE CASING	STAINLESS STEEL	304	316
1d	O-RING	NBR		
2	VALVE CAP	STAINLESS STEEL	304	316
3	VALVE SEAT	STAINLESS STEEL	304	316
3a	LOWER VALVE SEAT RETAINER	STAINLESS STEEL	304	316
3b	UPPER VALVE SEAT RETAINER	STAINLESS STEEL	304	316
4	TOP CHAMBER CUP	STAINLESS STEEL	304	316
6	UPPER BEARING	STAINLESS STEEL	304	316
7	NECKRING	NBR/PPS		
8	BEARING	NBR		
8a	WASHER FOR STOP RING	CARBON/GRAPHITE HY22 IN PTFE MASS		
8b	STOP RING	STAINLESS STEEL	304	316
9	CHAMBER	STAINLESS STEEL	304	316
11	SPLIT CONE NUT	STAINLESS STEEL	304	316
11c	NUT FOR STOP RING	STAINLESS STEEL	304	316
12	SPLIT CONE	STAINLESS STEEL	304	316
13	IMPELLER	STAINLESS STEEL	304	316
14	SUCTION INTERCONNECTOR	STAINLESS STEEL	304	316
15	STRAINER	STAINLESS STEEL	304	316
16	SHAFT COMPLETE	STAINLESS STEEL	304	316
17	STRAP	STAINLESS STEEL	304	316
18	CABLE GAURD	STAINLESS STEEL	304	316
19	NUT FOR STRAP	STAINLESS STEEL	304	316
39	SPRING FOR VALVE CUP	STAINLESS STEEL	304	316
70	VALVE GUIDE	STAINLESS STEEL	304	316
71	WASHER	STAINLESS STEEL	304	316
72	WEAR RING	STAINLESS STEEL	304	316

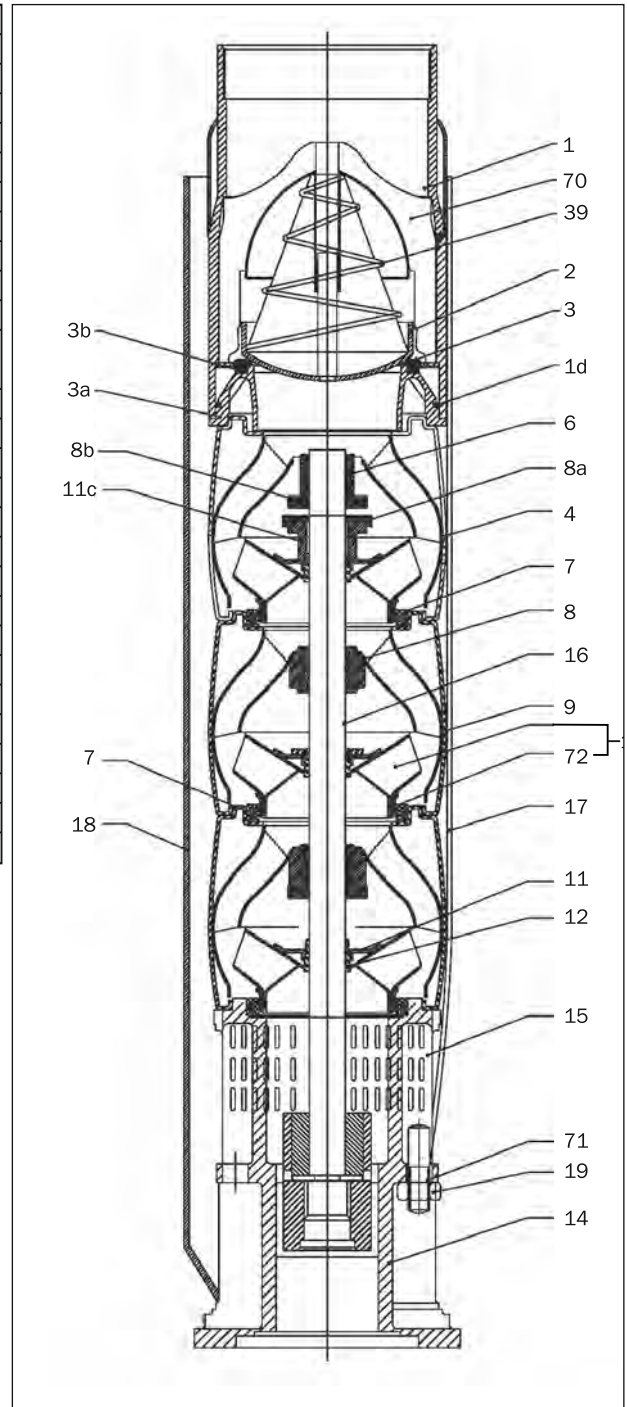

SUBMERSIBLE MOTORS

FEATURES AND BENEFITS

A COMPLETE MOTOR RANGE

We offer a complete submersible motor range

- 3"motors, single phase up to 1.5 kW (Rewindable)
- 4"motors, single-phase up to 4 kW. (Encapsulated & Rewindable)
- 4"motors, three-phase up to 7.5 kW. (Encapsulated & Rewindable)
- 6"motors, three-phase from 2.2 kW to 37 kW. (Rewindable)
- 8"motors, three-phase from 11 kW to 220 kW. (Rewindable)

HIGH MOTOR EFFICIENCY

Within the area of high motor efficiency Star is a market leader. This is due to newly developed motor concept which is introduced with the Premium 100, Premium 101 and Premium 150.

SHAFT SEAL

The choice of material is ceramic/ tungsten carbide providing optimum sealing, optimum wear resistance and long life.

The spring loaded shaft seal is designed with a large surface and a sand shield. The result is a minimum exchange of pumped and motor liquids and no penetration of particles.

PROTECTION AGAINST UPTHRUST

In case of a very small counter pressure in connection with start-up there is a risk that the entire pump body may rise. This is called upthrust. Upthrust may damage both pump and motor. Therefore, both pumps and motors are protected against upthrust as standard, preventing upthrust from occurring in the critical start-up phase. The protection consists of either a built-in stop ring or hydraulic balancing.

BUILT -IN COOLING CHAMBERS

In all submersible motors an efficient cooling is ensured by cooling chambers at the top and at the bottom of the motor, and by an internal circulation of motor liquid. As long as the required flow velocity cooling of the motor will be efficient.



FEATURES AND BENEFITS

OVER TEMPERATURE PROTECTION

For Shakti submersible motors accessories Pt100 for protection against over temperature is available. When the temperature becomes too high, the protection device will cut-out and damage to the pump and motor be avoided.

PROTECTION AGAINST UPTHRUST

In case of a very small counter pressure in connection with start-up there is a risk that the entire pump body may rise. This is called upthrust. Upthrust may damage both pump and motor. Therefore both Shakti pumps and motors are protected against upthrust as standard, preventing upthrust from occurring in the critical startup phase. The protection consists of a built-in upthrust ring.

EXAMPLE : 6" MTSF

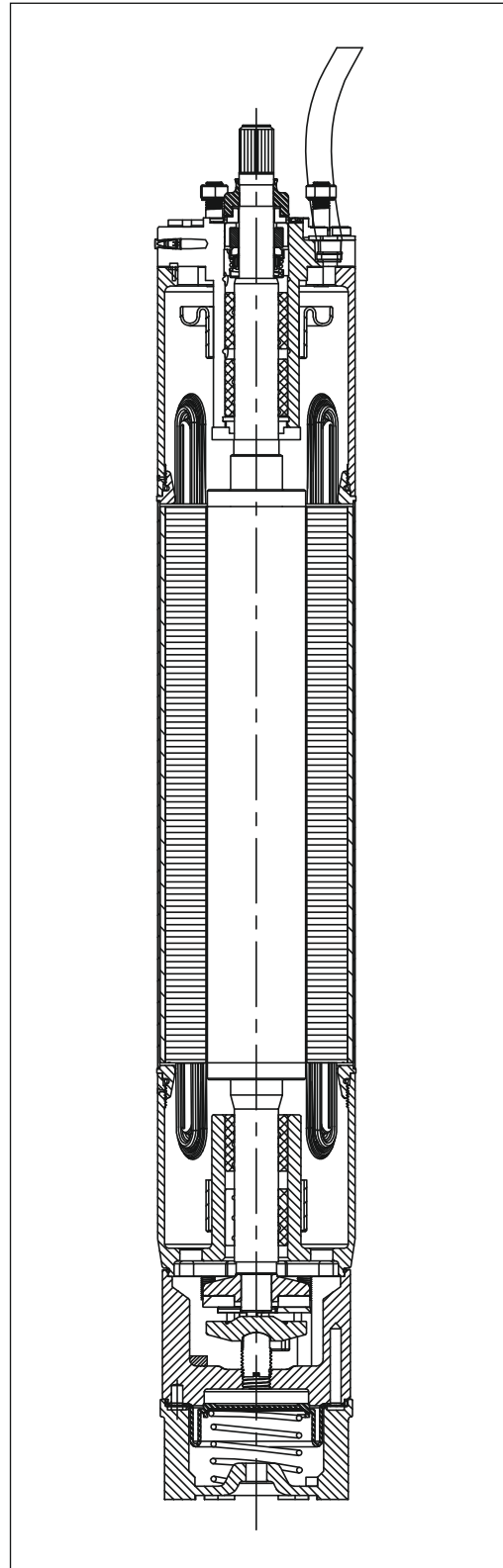

SECTIONAL VIEW OF 3 INCH MOTOR

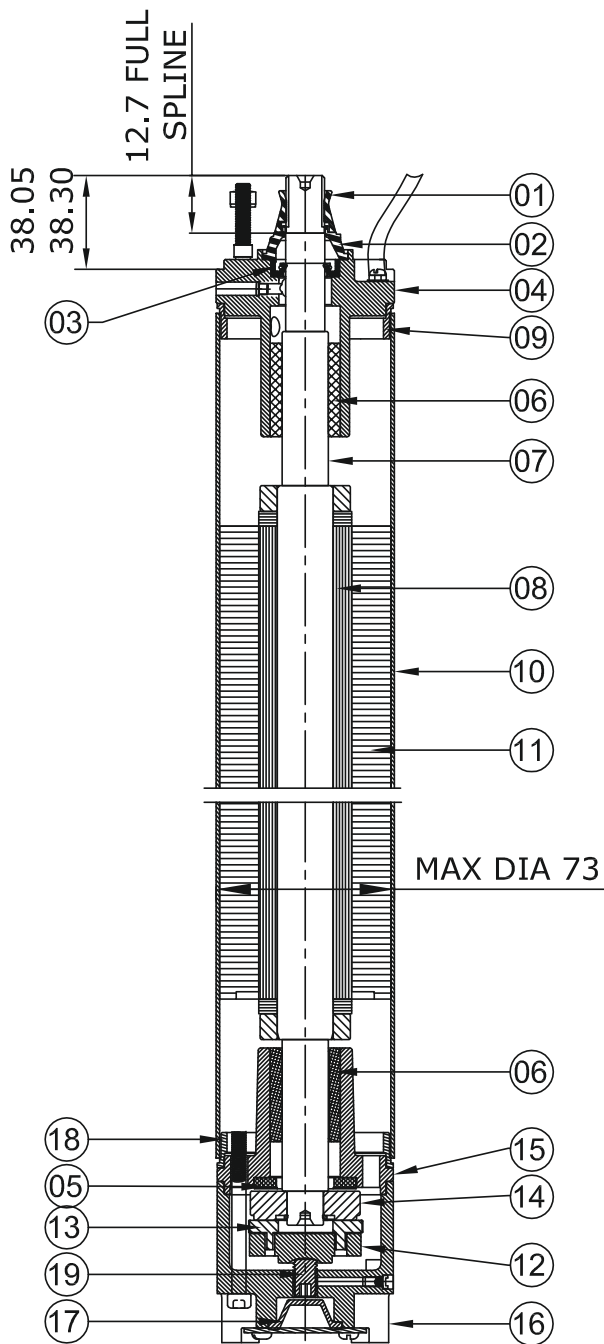

MATERIAL SPECIFICATION 3 INCH MOTOR

SR.NO.	PART	MATERIAL
1	SAND SLINGER	NBR
2	SEAL COVER	PPS
3	OIL SEAL	NBR + SS AISI 304
4	TOP END BELL	CI FG-260
5	UP THRUST WASHER	PP
6	BUSH	CARBON WITH RESIGN IMPREGATED
7	ROTOR SHAFT	SS AISI 420
8	ROTOR SUB ASSLY	N/A
9	TOP FLANGE	MS
10	STATOR PIPE	SS AISI-304
11	STATOR SUB ASSLY	N/A
12	THRUST BEARING PLATE	CI FG-260
13	THRUST PAD	SS AISI-420
14	REVOLVING PLATE ASSLY	NA
15	BOTTOM END BELL	CI FG-260
16	MOTOR BASE	CI FG-260
17	DIAPHRAGM	NBR
18	BOTTOM FLANGE	MS
19	ADJUSTING STUD	SS AISI-410

SECTIONAL VIEW OF 4" PREMIUM 100

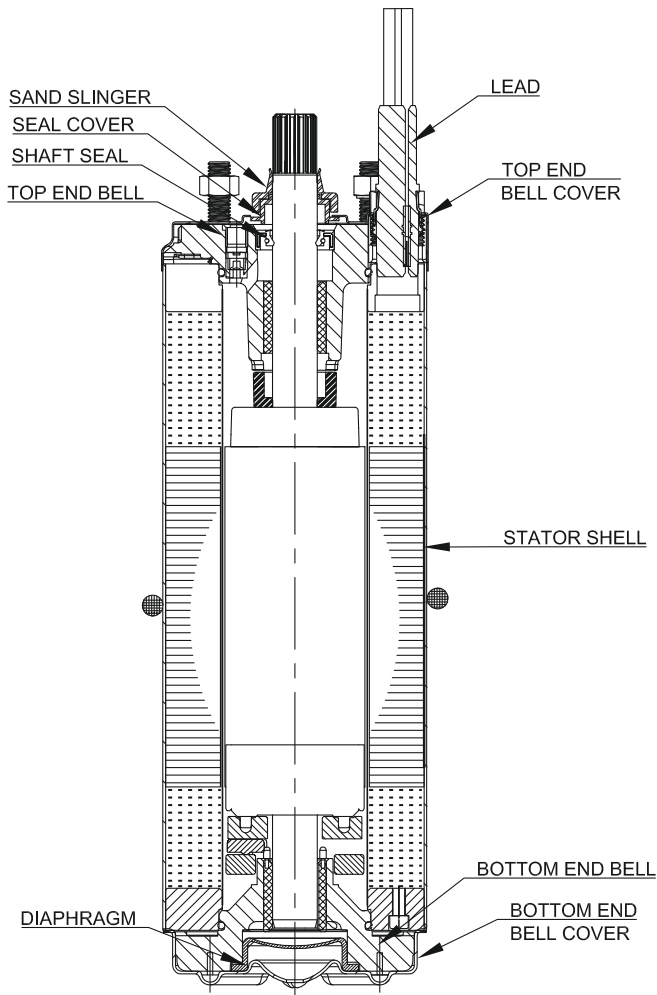

MATERIAL SPECIFICATION 4" PREMIUM-100

PART	MATERIAL	
	AISI SS 304	AISI SS 316
SHAFT END	DUPLEX	DUPLEX
SAND SLINGER	NBR	NBR
SEAL COVER	AISI SS 304	AISI SS 316
TOP END BELL COVER	AISI SS 304	AISI SS 316
TOP END BELL	CAST IRON POWDER COATED	CAST IRON POWDER COATED
SEALS	NBR	NBR
STATOR SHELL	AISI SS 304	AISI SS 316
SHAFT SEAL	EPDM + AISI SS 304	EPDM + AISI SS 304
BOTTOM END BELL	CAST IRON POWDER COATED	CAST IRON POWDER COATED
BOTTOM END BELL COVER	AISI SS 304	AISI SS 316
DIAPHRAGM	EPDM	EPDM
LEAD	XLPE	XLPE

SECTIONAL VIEW OF 4" PREMIUM 101

MATERIAL SPECIFICATION 4" PREMIUM-101

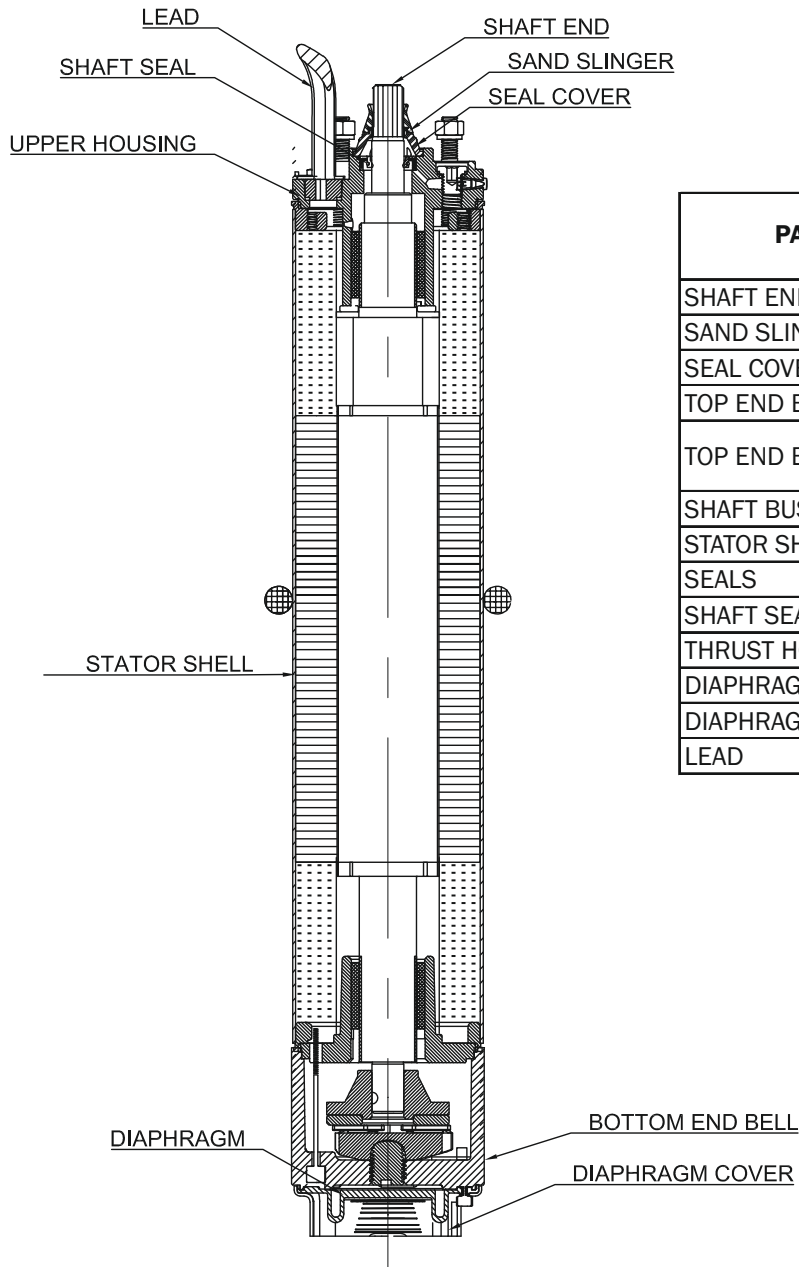

PART	MATERIAL	
	AISI SS 304	AISI SS 316
SHAFT END	DUPLEX	DUPLEX
SAND SLINGER	NBR	NBR
SEAL COVER	AISI SS 304	AISI SS 316
TOP END BELL COVER	AISI SS 304	AISI SS 316
TOP END BELL	CAST IRON POWDER COATED	CAST IRON POWDER COATED
SHAFT BUSH	NYLON 30% GLASS	NYLON 30% GLASS
STATOR SHELL	AISI SS 304	AISI SS 316
SEALS	NBR	NBR
SHAFT SEAL	EPDM+AISI SS 304	EPDM+AISI SS 304
THRUST HOUSING	AISI SS 304	AISI SS 316
DIAPHRAGM COVER	AISI SS 304	AISI SS 316
DIAPHRAGM	EPDM	EPDM
LEAD	XLPE	XLPE

SECTIONAL VIEW OF 4" MCIP 100

MATERIAL SPECIFICATION 4" MCIP-100

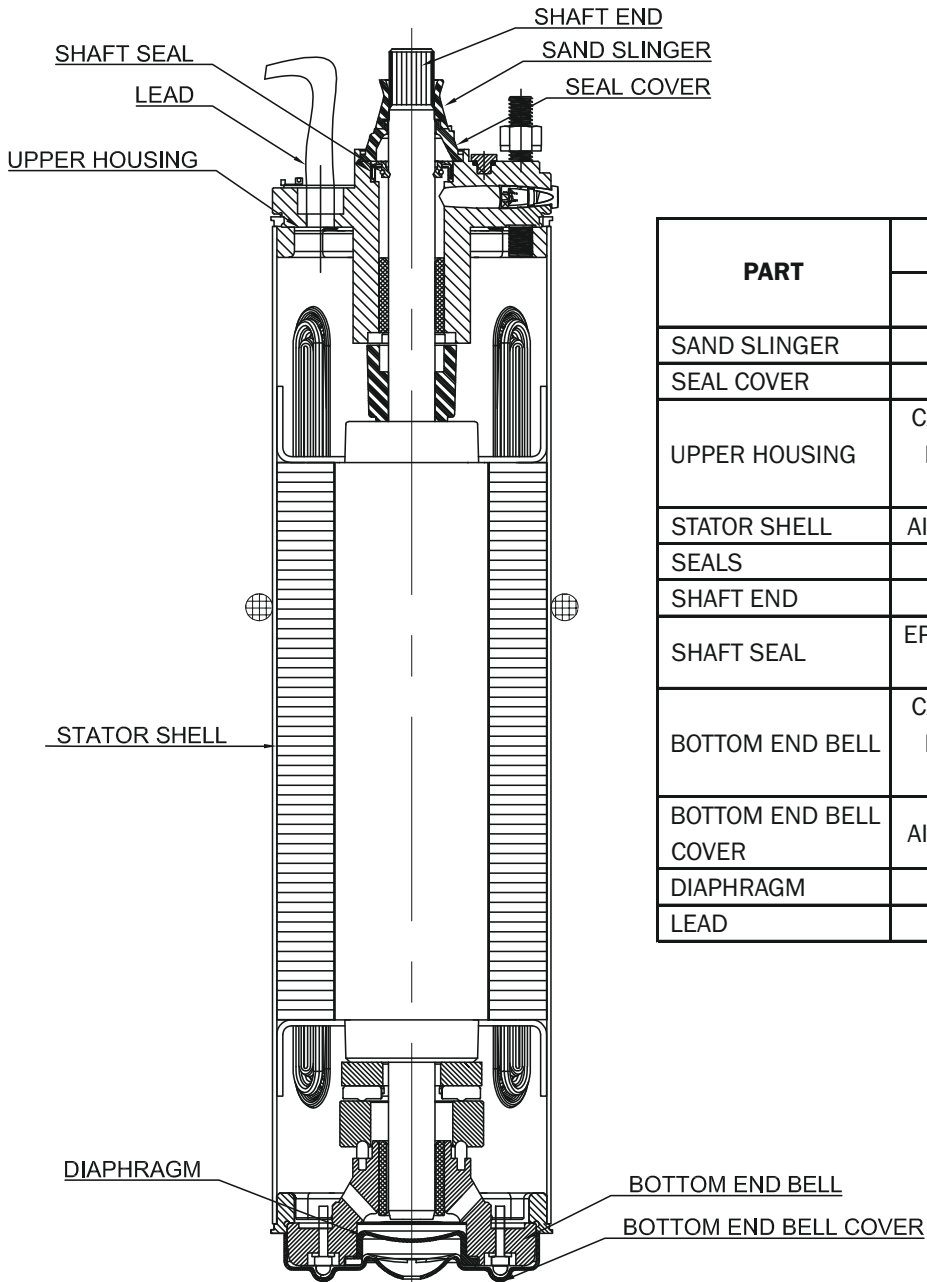

PART	MATERIAL		
	CI	AISI SS 304	AISI SS 316
SAND SLINGER	NBR	NBR	NBR
SEAL COVER	PPS	PPS	PPS
UPPER HOUSING	CAST IRON POWDER COATED	AISI SS 304	AISI SS 316
STATOR SHELL	AISI SS 304	AISI SS 304	AISI SS 316
SEALS	NBR	NBR	NBR
SHAFT END	DUPLEX	DUPLEX	DUPLEX
SHAFT SEAL	EPDM + AISI SS 304	EPDM + AISI SS 304	EPDM + AISI SS 304
BOTTOM END BELL	CAST IRON POWDER COATED	CAST IRON POWDER COATED	CAST IRON POWDER COATED
BOTTOM END BELL COVER	AISI SS 304	AISI SS 304	AISI SS 316
DIAPHRAGM	EPDM	EPDM	EPDM
LEAD	EPR	EPR	EPR

SECTIONAL VIEW OF 4" MCIP 101

MATERIAL SPECIFICATION 4" MCIP-101

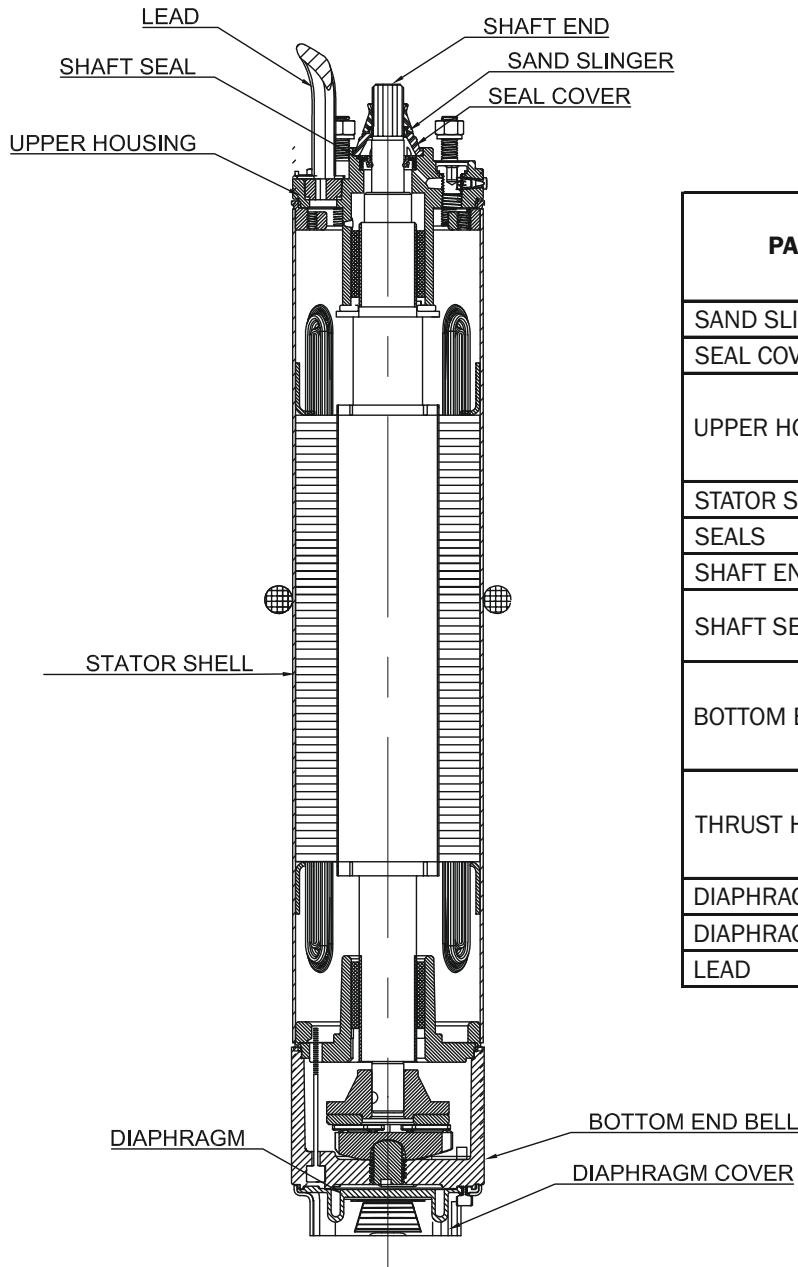

PART	MATERIAL		
	CI	AISI SS 304	AISI SS 316
SAND SLINGER	NBR	NBR	NBR
SEAL COVER	PPS	PPS	PPS
UPPER HOUSING	CAST IRON POWDER COATED	AISI SS 304	AISI SS 316
STATOR SHELL	AISI SS 304	AISI SS 304	AISI SS 316
SEALS	NBR	NBR	NBR
SHAFT END	DUPLEX	DUPLEX	DUPLEX
SHAFT SEAL	EPDM + AISI SS 304	EPDM + AISI SS 304	EPDM + AISI SS 304
BOTTOM END BELL	CAST IRON POWDER COATED	CAST IRON POWDER COATED	CAST IRON POWDER COATED
THRUST HOUSING	CAST IRON POWDER COATED	AISI SS 304	AISI SS 316
DIAPHRAGM COVER	AISI SS 304	AISI SS 304	AISI SS 316
DIAPHRAGM	EPDM	EPDM	EPDM
LEAD	EPR	EPR	EPR

SECTIONAL VIEW OF 6" PREMIUM SILVER

MATERIAL SPECIFICATION 6" PREMIUM SILVER

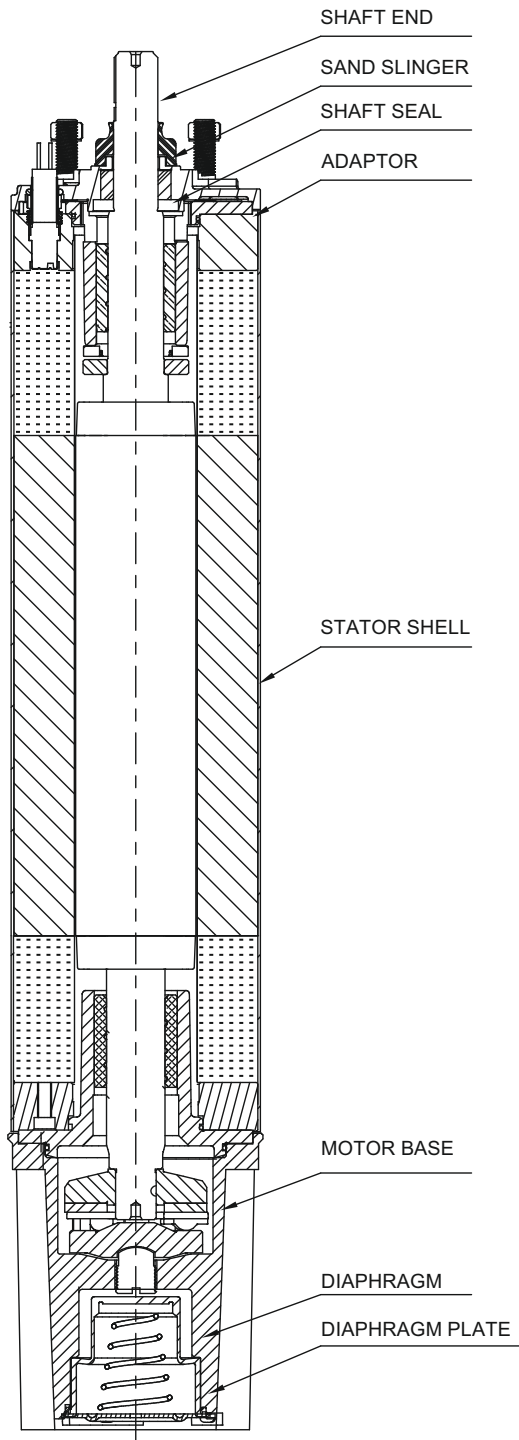

LIST OF MATERIAL

PART	MATERIAL
ADAPTOR	AISI SS 304
STATOR SHELL	AISI SS 304
SEALS	NBR
SAND SLINGER	NBR
SHAFT END	DUPLEX
SHAFT SEAL	EPDM + AISI SS 304
MOTOR BASE	AISI SS 304
DIAPHRAGM	EPDM
DIAPHRAGM PLATE	AISI SS 304
LEAD	EPR

SECTIONAL VIEW OF 6" MTSF

MATERIAL SPECIFICATION 6" MTSF

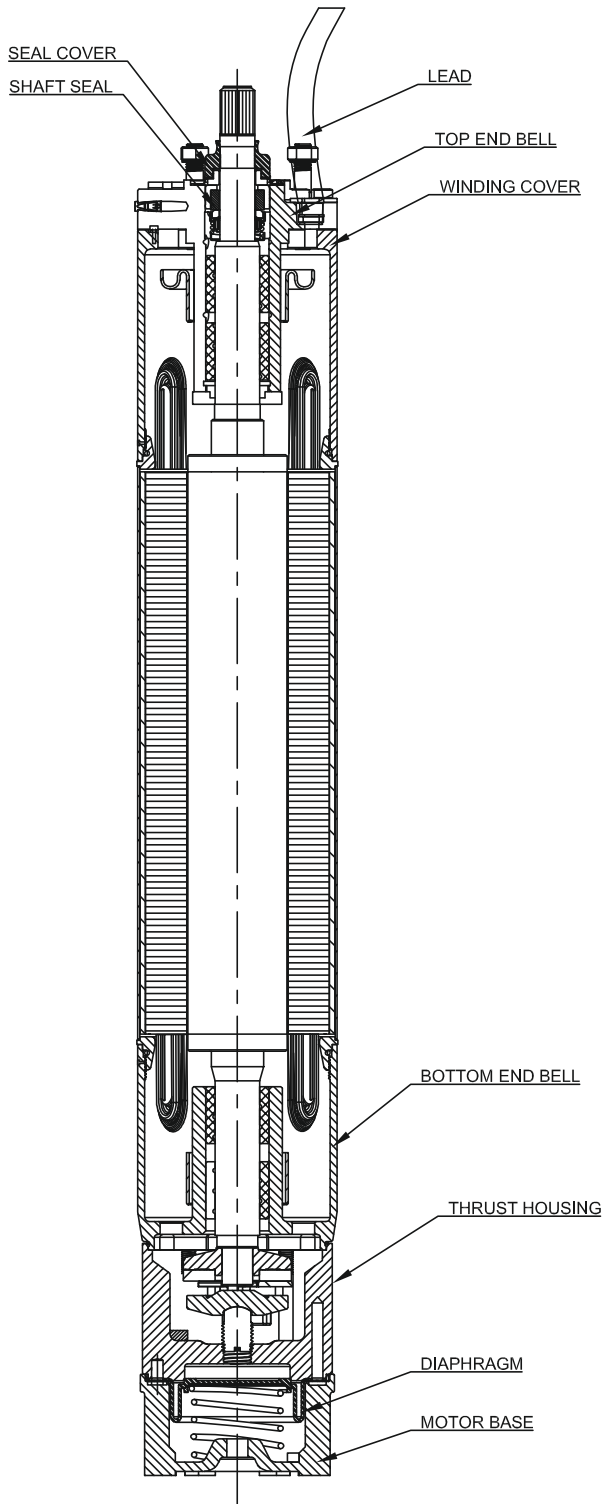

PART	MATERIAL		
	CI	AISI SS 304	AISI SS 316
TOP END BELL	CAST IRON POWDER COATED	AISI SS 304	AISI SS 316
WINDING COVER	CAST IRON POWDER COATED	AISI SS 304	AISI SS 316
STATOR SHELL	AISI SS 304	AISI SS 304	AISI SS 316
SEALS	NBR	NBR	NBR
SEAL COVER	AISI SS 304	AISI SS 304	AISI SS 316
SHAFT END	DUPLEX	DUPLEX	DUPLEX
SHAFT SEAL	SIC	SIC	SIC
MOTOR BASE	CAST IRON POWDER COATED	AISI SS 304	AISI SS 316
THRUST HOUSING	CAST IRON POWDER COATED	AISI SS 304	AISI SS 316
BOTTOM END BELL	CAST IRON POWDER COATED	AISI SS 304	AISI SS 316
DIAPHRAGM	EPDM	EPDM	EPDM
LEAD	EPR	EPR	EPR

MATERIAL SPECIFICATION 6" SML SILVER

MATERIAL SPECIFICATION 6" SML SILVER

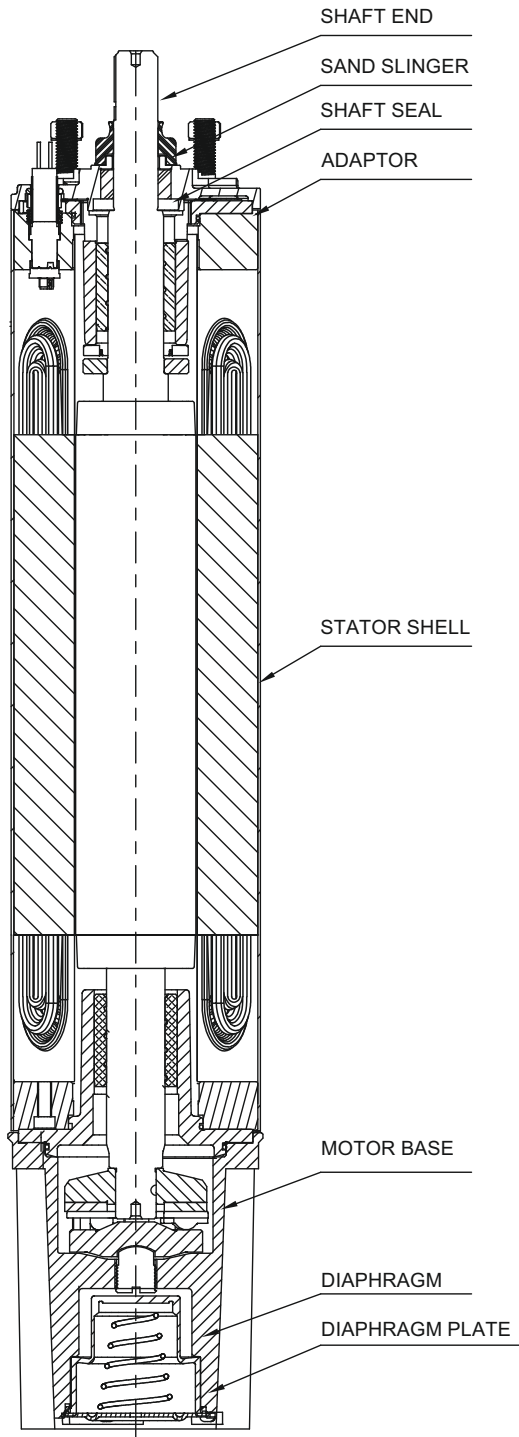

PART	MATERIAL		
	CI	AISI SS 304	AISI SS 316
UPPER HOUSING	CAST IRON POWDER COATED	AISI SS 304	AISI SS 316
STATOR SHELL	AISI SS 304	AISI SS 304	AISI SS 316
SEALS	NBR	NBR	NBR
SAND SLINGER	NBR	NBR	NBR
SHAFT END	DUPLEX	DUPLEX	DUPLEX
SHAFT SEAL	EPDM + AISI SS 304	EPDM + AISI SS 304	EPDM + AISI SS 304
MOTOR BASE	CAST IRON POWDER COATED	AISI SS 304	AISI SS 316
DIAPHRAGM	EPDM	EPDM	EPDM
DIAPHRAGM PLATE	AISI SS 304	AISI SS 304	AISI SS 316
LEAD	EPR	EPR	EPR

SECTION VIEW 8" MTSF

MATERIAL SPECIFICATION 8" MTSF

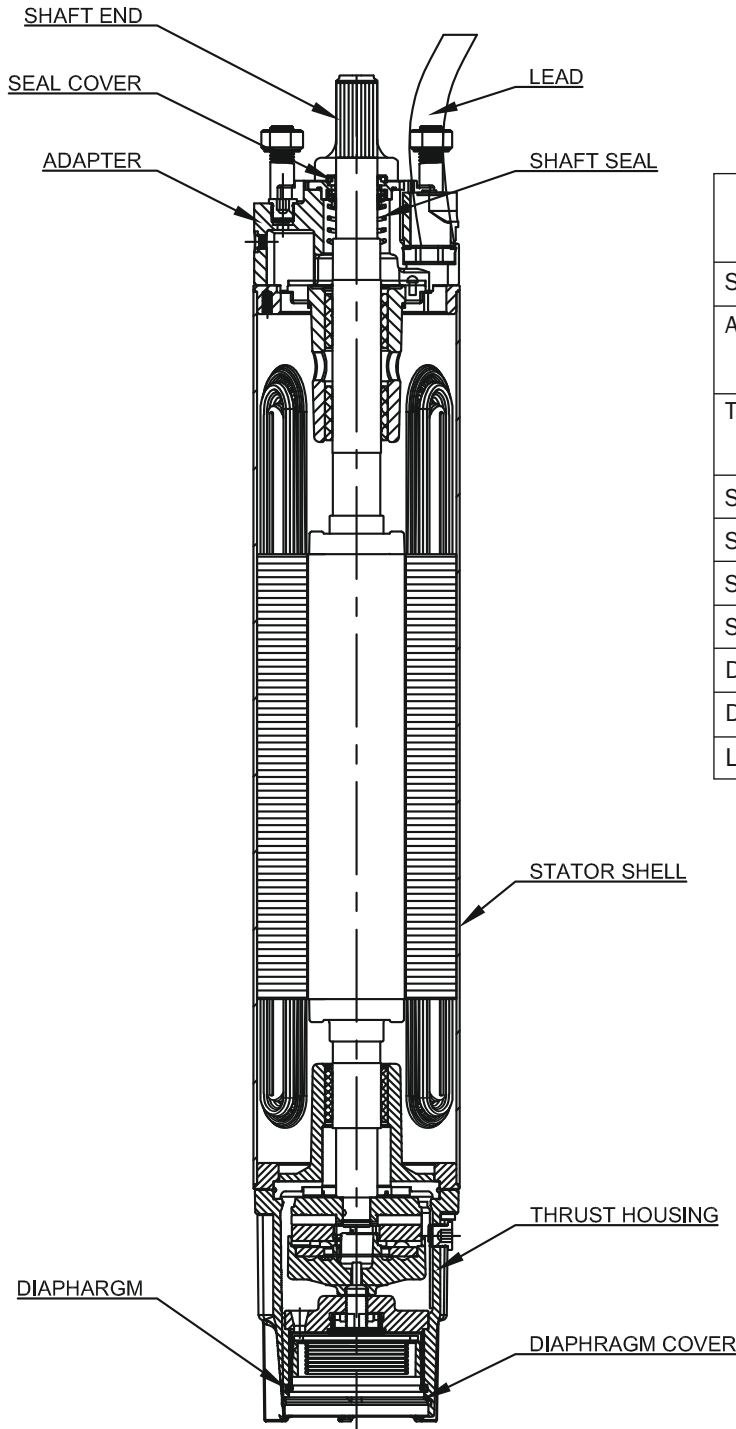

Part	Material DIN/AISI		
	CI	AISI SS 304	AISI SS 316
Stator shell	AISI SS 304	AISI SS 304	AISI SS 316
Adapter	Cast Iron Powder Coated	AISI SS 304	AISI SS 316
Thrust Housing	Cast Iron Powder Coated	AISI SS 304	AISI SS 316
Seals	NBR	NBR	NBR
Seal Cover	AISI SS 304	AISI SS 304	AISI SS 316
Shaft Seal	SiC	SiC	SiC
Shaft end	Duplex	Duplex	Duplex
Diaphragm	EPDM	EPDM	EPDM
Diaphragm Cover	AISI SS 304	AISI SS 304	AISI SS 316
Lead	EPR	EPR	EPR

SUBMERSIBLE MOTORS



SECTIONAL VIEW OF 10" MTSF

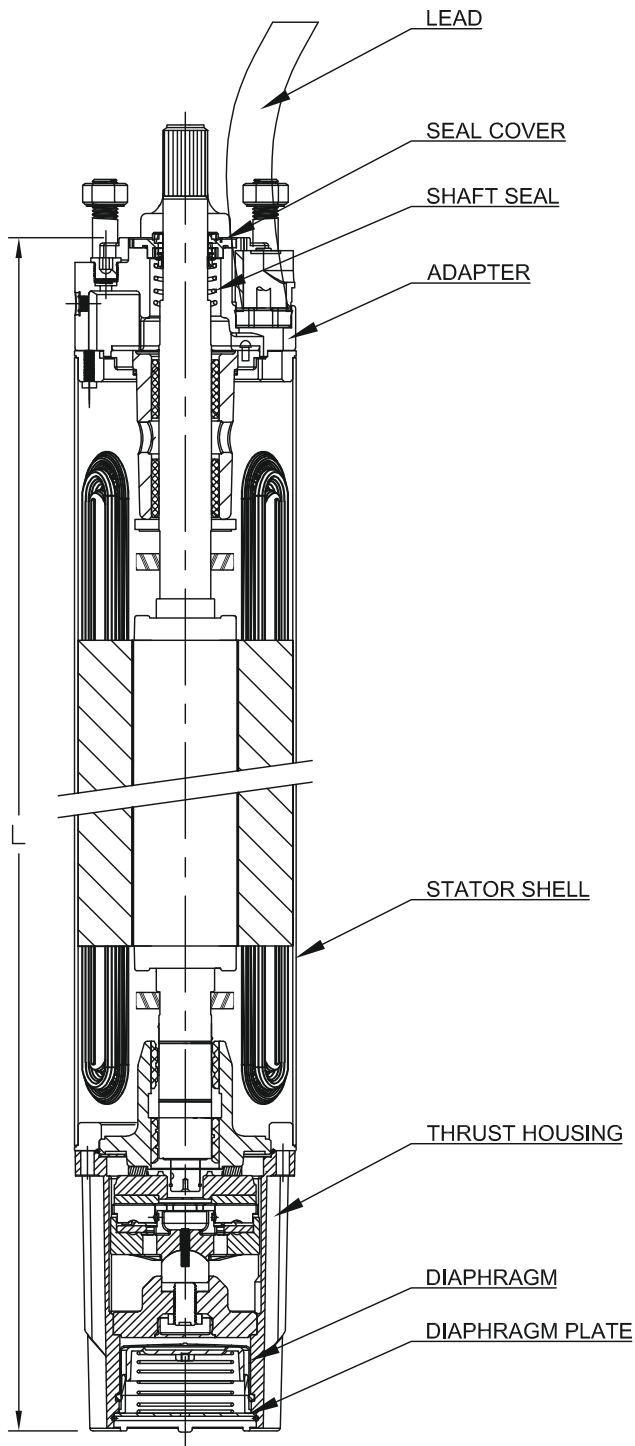

MATERIAL SPECIFICATION 10" MTSF

PART	MATERIAL		
	CI	AISI SS 304	AISI SS 316
ADAPTER	CAST IRON POWDER COATED	AISI SS 304	AISI SS 316
STATOR SHELL	AISI SS 304	AISI SS 304	AISI SS 316
SEALS	NBR	NBR	NBR
SEAL COVER	AISI SS 304	AISI SS 304	AISI SS 316
SHAFT SEAL	SIC	SIC	SIC
MOTOR BASE	CAST IRON POWDER COATED	AISI SS 304	AISI SS 316
DIAPHRAGM	EPDM	EPDM	EPDM
DIAPHRAGM COVER	AISI SS 304	AISI SS 304	AISI SS 316
LEAD	EPR	EPR	EPR

SECTIONAL VIEW OF 12" MTSF

MATERIAL SPECIFICATION 12" MTSF

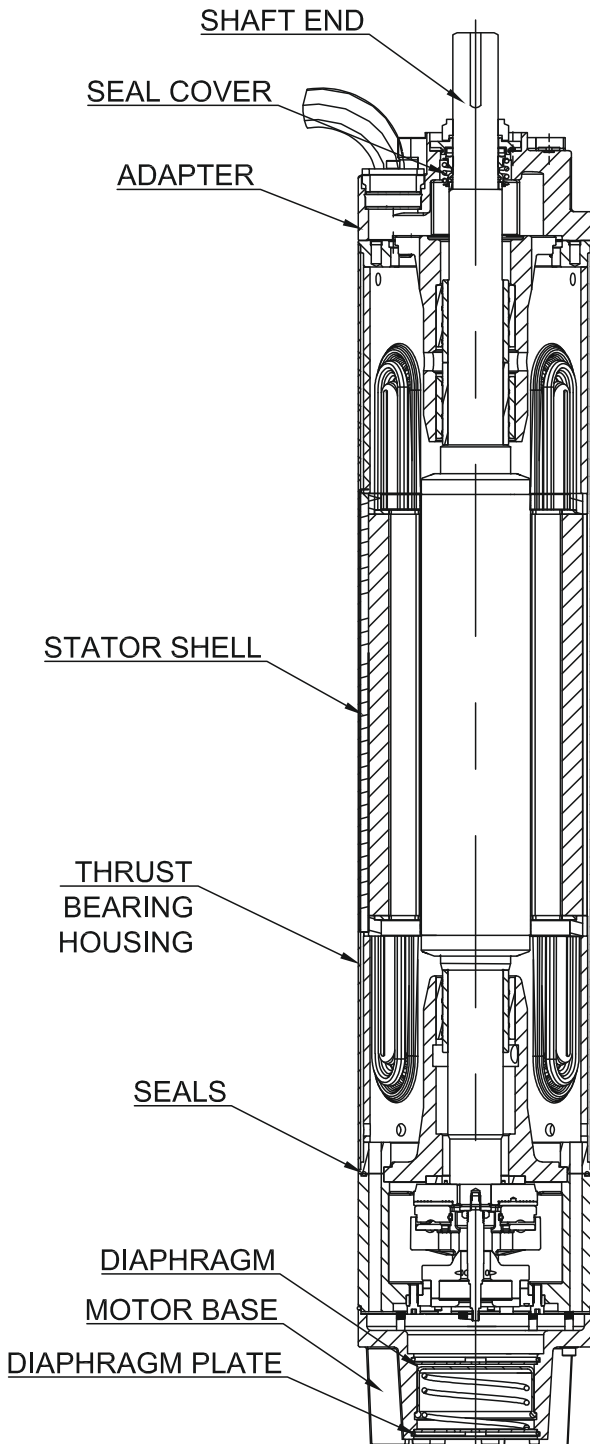

PART	MATERIAL		
	CI	AISI SS 304	AISI SS 316
ADAPTER	CAST IRON POWDER COATED	AISI SS 304	AISI SS 316
STATOR SHELL	AISI SS 304	AISI SS 304	AISI SS 316
SEALS	NBR	NBR	NBR
SEAL COVER	AISI SS 304	AISI SS 304	AISI SS 316
SHAFT SEAL	SIC	SIC	SIC
MOTOR BASE	CAST IRON POWDER COATED	AISI SS 304	AISI SS 316
THRUST HOUSING	CAST IRON POWDER COATED	AISI SS 304	AISI SS 316
DIAPHRAGM	EPDM	EPDM	EPDM
DIAPHRAGM COVER	AISI SS 304	AISI SS 304	AISI SS 316
LEAD	EPR	EPR	EPR

PERFORMANCE CURVE



SUBMERSIBLE PUMP Q 3

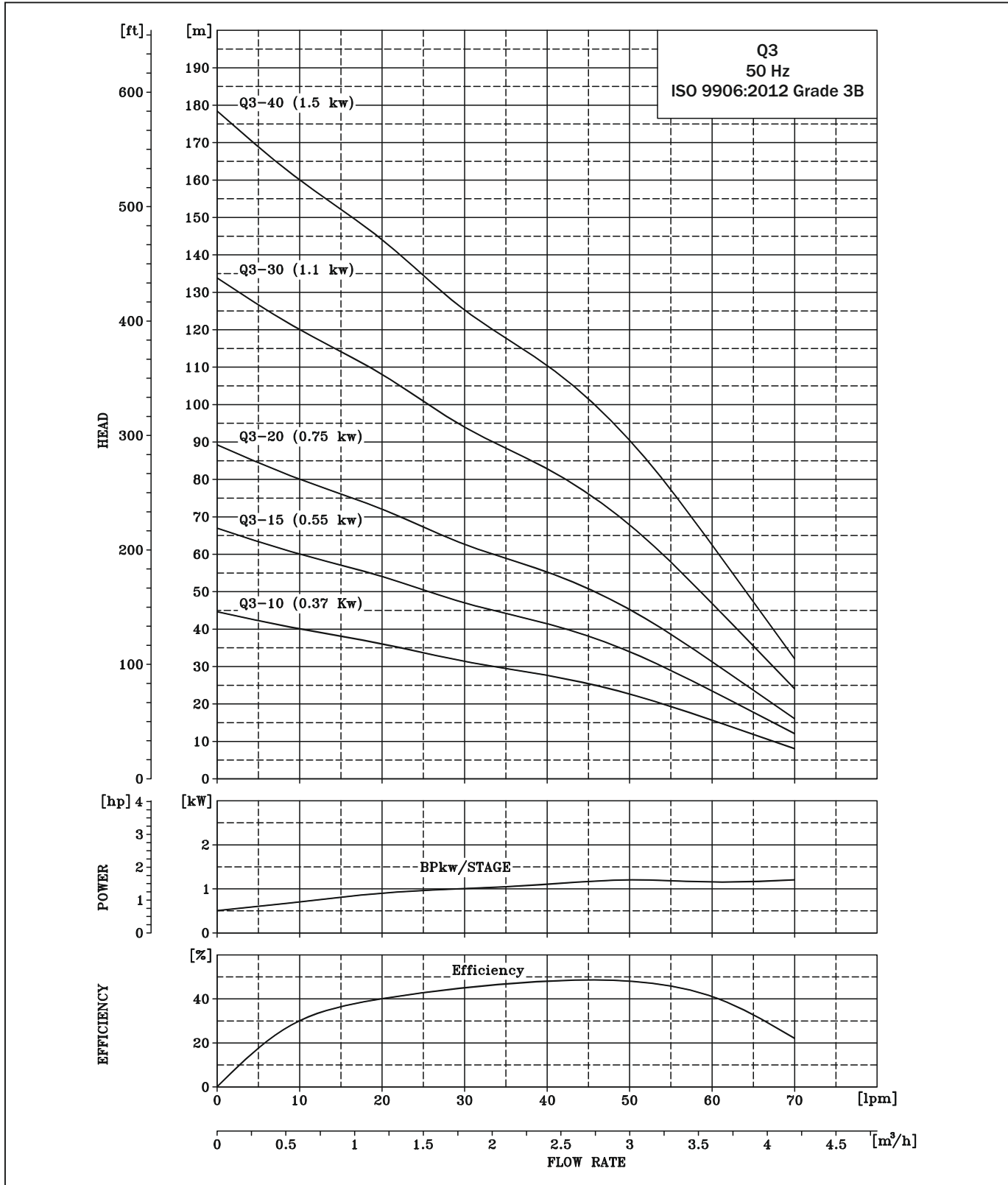

SUBMERSIBLE PUMP Q 3

DIMENSIONS AND WEIGHTS

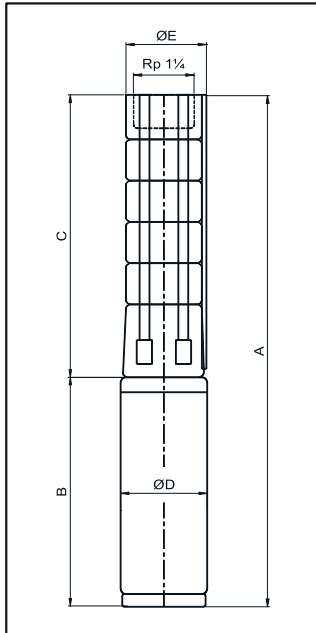

E = Maximum diameter of pump inclusive of cable guard & motor.

TECHNICAL DATA Q 3

PUMP TYPE	MOTOR		DIMENSIONS (mm)					NET WEIGHT (kg)	
	TYPE*	POWER (kW)	C	B	A	D	E	PUMP	MOTOR
				1x230V	1x230V				1x230V
Q3 - 10	V3 MOTOR	0.37	402	501	903	73	83	3	9
Q3 - 15	V3 MOTOR	0.55	507	501	1008	73	83	4	10
Q3 - 20	V3 MOTOR	0.75	612	551	1163	73	83	5	12
Q3 - 30	V3 MOTOR	1.1	822	601	1423	73	83	7	15
Q3 - 40	V3 MOTOR	1.5	1032	-	-	73	83	8	18

* Motor type may change as per requirement .

PERFORMANCE TABLE Q 3

QF-3					DISCHARGE (Q)							
					m ³ /h	0.6	1.2	1.8	2.4	3	4.2	
					l/min.	10	20	30	40	50	70	
MODEL	CONNECTION	MATERIAL CODE (4x4)	MOTOR RATING		1~	3~	TOTAL HEAD IN (m)					
			[kW]	[HP]	[A]	[A]						
Q-3-10	Rp1¼	9000017891	0.37	0.5	4.1	-	40	36	32	27	23	10
Q-3-15		9000018520	0.55	0.75	6.2	-	60	53	47	41	34	15
Q-3-20		9000018521	0.75	1	8.3	-	80	71	62	55	45	20
Q-3-26		-	0.93	1.25	10	-	104	93	81	72	59	26
Q-3-30		9000018522	1.1	1.5	12.5	-	120	107	94	83	68	24
Q-3-40		9000018523	1.5	2	16.5	-	160	142	125	110	90	40

PERFORMANCE CURVE



SUBMERSIBLE PUMP QF 1

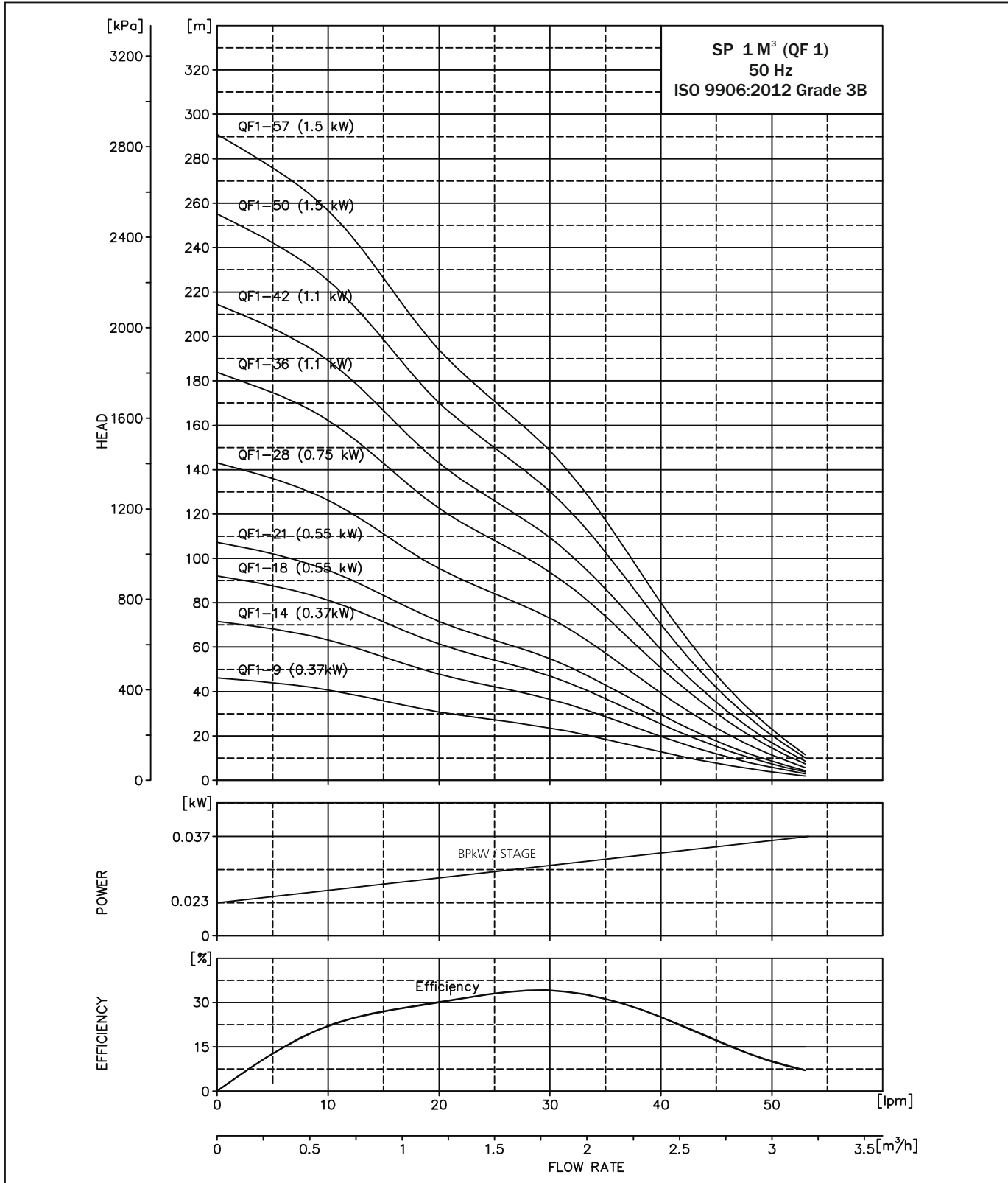

SUBMERSIBLE PUMP QF 1

DIMENSIONS AND WEIGHTS

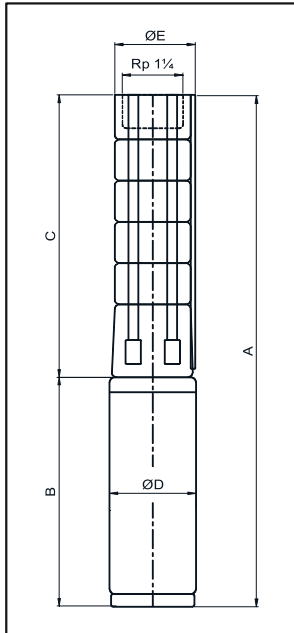

E = Maximum diameter of pump inclusive of cable guard & motor.

TECHNICAL DATA QF 1

PUMP TYPE	MOTOR		DIMENSIONS (mm)							NET WEIGHT (kg)		
	TYPE	POWER (kW)	C	B		A		D	E	PUMP	MOTOR	
				1x230V	3x220V 3x400V	1x230V	3x220V 3x400V				1x230V	3x220V 3x400V
QF 1 - 9	PREMIUM 100	0.37	426	242	271	668	697	95	97	6.0	10	11
QF 1 - 14	PREMIUM 100	0.37	531	242	271	773	802	95	97	7.1	10	11
QF 1 - 18	PREMIUM 100	0.55	615	291	271	906	886	95	97	8.0	11	11
QF 1 - 21	PREMIUM 100	0.55	678	291	271	969	949	95	97	8.7	11	11
QF 1 - 28	PREMIUM 100	0.75	825	291	291	1116	1116	95	97	10.2	11	12
QF 1 - 36	PREMIUM 100	1.1	993	339	339	1332	1332	95	97	11.9	15	15
QF 1 - 42	PREMIUM 100	1.1	1119	339	339	1458	1458	95	97	13.0	15	15
QF 1 - 50	PREMIUM 100	1.5	1287	404	404	1691	1691	95	97	14.0	17	17
QF 1 - 57	PREMIUM 100	1.5	1434	404	404	1838	1838	95	97	15.0	17	17

* Motor type may change as per requirement .

PERFORMANCE TABLE QF 1

QF-1					DISCHARGE								
					m ³ / h		0	0.6	1.2	1.5	1.8	2.4	3
					l/min		0	10	20	25	30	40	50
MODEL	CONNECTION	MATERIAL CODE (4X4)	MOTOR RATING		TOTAL HEAD IN (M)								
			(KW)	(HP)	1 (A)	3 (A)							
QF 1-9	RP 1 ¼	9000002475	0.37	0.5	2.9	1.4	46	40	30	27	23	13	4
QF1-14		9000002460	0.37	0.5	2.9	1.4	72	63	47	43	35	20	7
QF 1-18		9000002462	0.55	0.75	4	2.2	93	80	60	55	45	26	8
QF 1-21		9000002463	0.55	0.75	4	2.2	108	94	71	64	53	30	10
QF 1-28		9000002466	0.75	1	5.5	2.3	144	125	94	85	70	40	13
QF 1-36		9000002468	1.1	1.5	8.2	3.4	185	161	121	109	90	51	17
QF 1-42		9000002470	1.1	1.5	8.2	3.4	216	188	141	128	105	60	20
QF 1-50		9000002472	1.5	2	10.2	4.2	257	223	168	152	125	71	23
QF 1-57		9000002473	1.5	2	10.2	4.2	293	254	191	173	143	81	26

PERFORMANCE CURVE



SUBMERSIBLE PUMP QF 2

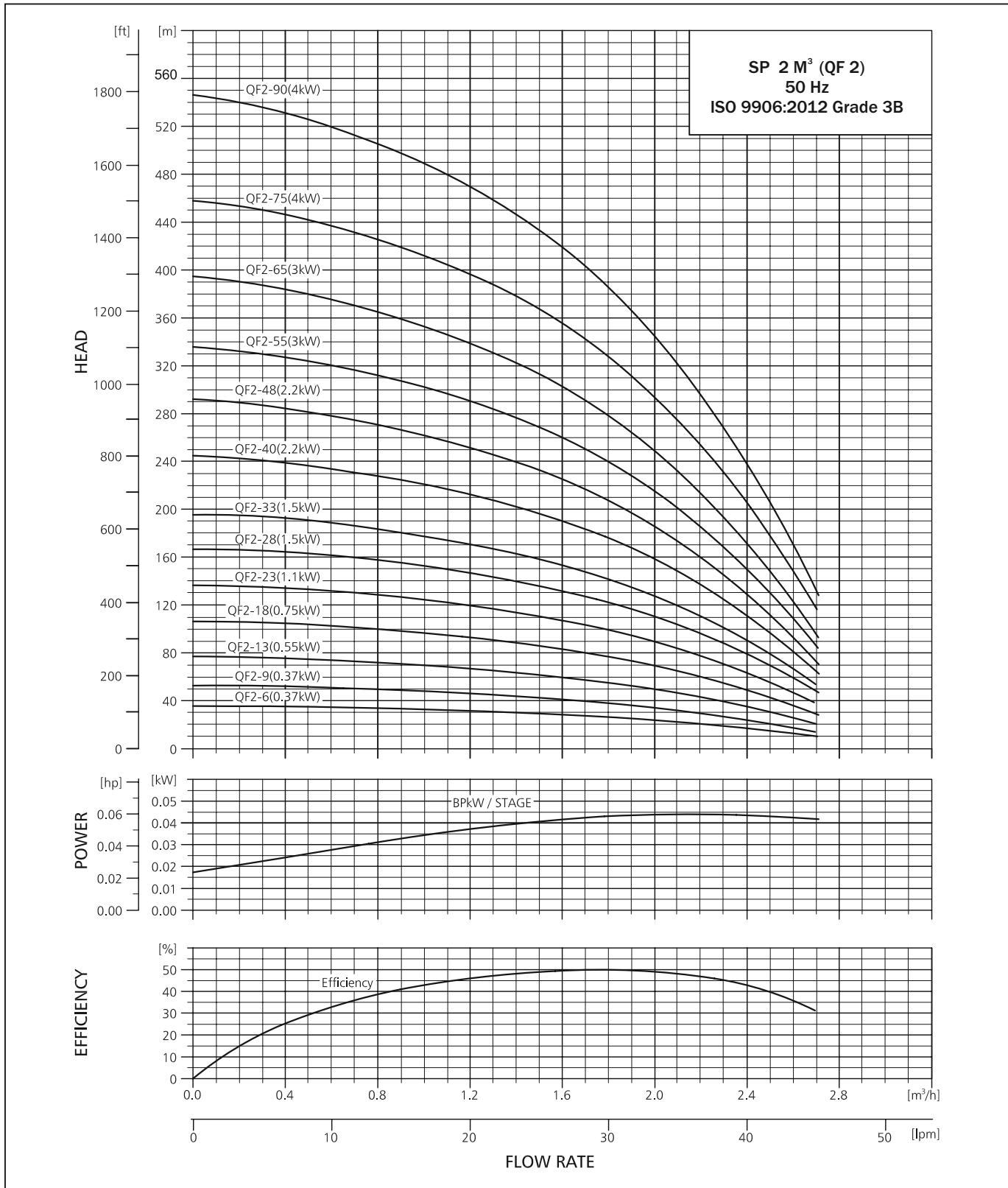

SUBMERSIBLE PUMP QF 2

DIMENSIONS AND WEIGHTS

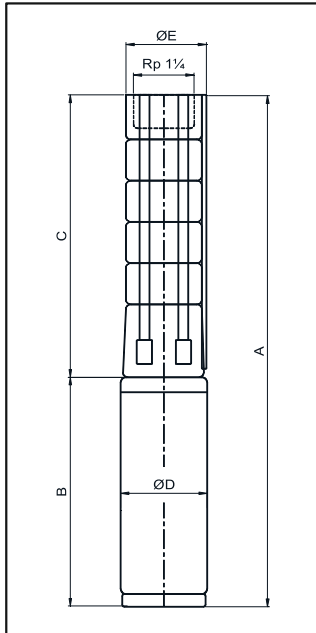

E = Maximum diameter of pump inclusive of cable guard & motor.

QF 2-65 to QF 2-90 are mounted in sleeve for R 1 1/4" connection and with max. diameter 108 mm.

TECHNICAL DATA QF 2

PUMP TYPE	MOTOR		C	DIMENSIONS (mm)				D	E	PUMP	NET WEIGHT (kg)	
	TYPE *	POWER (kW)		B		A					MOTOR	
				1x230V	3x220V 3x400V	1x230V	3x220V 3x400V				1x230V	3x220V 3x400V
QF 2 - 6	PREMIUM 100	0.37	363	242	271	605	634	95	97	5.4	10	11
QF 2 - 9	PREMIUM 100	0.37	426	242	271	668	697	95	97	6.0	10	11
QF 2 - 13	PREMIUM 100	0.55	510	291	271	801	781	95	97	6.9	11	11
QF 2 - 18	PREMIUM 100	0.75	615	291	291	906	906	95	97	8.0	11	12
QF 2 - 23	PREMIUM 100	1.1	720	339	339	1059	1059	95	97	9.1	15	15
QF 2 - 28	PREMIUM 100	1.5	825	404	404	1229	1229	95	97	10.2	17	17
QF 2 - 33	PREMIUM 100	1.5	930	404	404	1334	1334	95	97	11.3	17	17
QF 2 - 40	PREMIUM 100	2.2	1077	538	538	1615	1615	95	97	12.8	24	24
QF 2 - 48	PREMIUM 100	2.2	1571	538	538	2109	2109	95	97	18.9	24	24
QF 2 - 55	PREMIUM 100	3.0	1756	690	578	2446	2334	95	97	21.3	31	26
QF 2 - 65	PREMIUM 100	3.0	2060	690	578	2750	2638	95	97	24.8	31	26
QF 2 - 75	PREMIUM 101	4.0	2325	690	690	3015	3015	95	97	28.2	31	31
QF 2 - 90	PREMIUM 101	4.0	2722	690	690	3412	3412	95	97	33.4	31	31

* Motor type may change as per requirement .

PERFORMANCE TABLE QF 2

QF-2					DISCHARGE (Q)								
					m ³ /h		0	1	1.4	1.8	2	2.4	2.8
					l/min.		0	16.7	23.4	30.1	33.4	40.1	46.8
MODEL	CONNECTION	MATERIAL CODE (4x4)	MOTOR RATING		1~		TOTAL HEAD IN (m)						
			[kW]	[HP]	[A]	[A]							
QF 2-6	RP 1 1/4	9000002503	0.37	0.5	2.9	1.4	36	33	30	26	24	17	13
QF 2-9		9000002506	0.37	0.5	2.9	1.4	53	48	44	38	34	24	17
QF 2-13		9000002494	0.55	0.75	4	2.2	77	70	64	55	50	35	26
QF 2-18		9000002495	0.75	1	5.5	2.3	107	97	89	77	69	49	36
QF 2-23		9000002497	1.1	1.5	8.2	3.4	137	124	114	99	90	64	47
QF 2-28		9000002498	1.5	2	10.2	4.2	167	152	140	122	110	79	59
QF 2-33		9000002499	1.5	2	10.2	4.2	196	178	163	142	128	90	66
QF 2-40		9000002500	2.2	3	14	5.5	245	221	203	176	158	111	81
QF 2-48		9000002501	2.2	3	14	5.5	292	262	240	207	186	129	93
QF 2-55		9000002502	3	4	-	7.9	336	302	277	240	215	150	109
QF 2-65		SLEEVE	9000002504	3	4	-	7.9	390	358	325	280	0	0
QF 2-75	9000002505		4	5.5	-	9.6	450	413	375	323	0	0	0
QF 2-90	9000002507		4	5.5	-	9.6	540	495	450	0	0	0	194

PERFORMANCE CURVE



SUBMERSIBLE PUMP QF 5

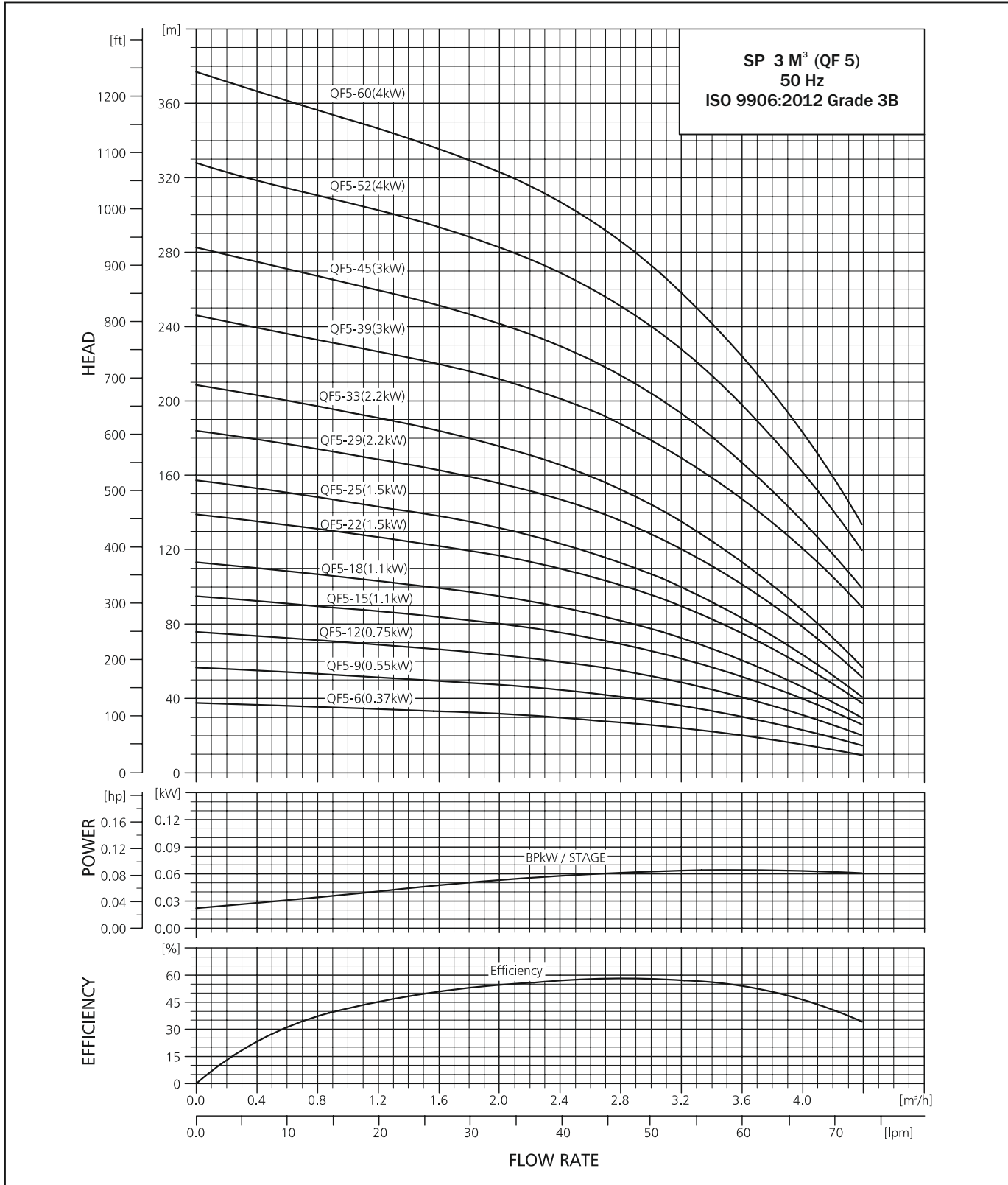

TECHNICAL DATA



SUBMERSIBLE PUMP QF 5

DIMENSIONS AND WEIGHTS

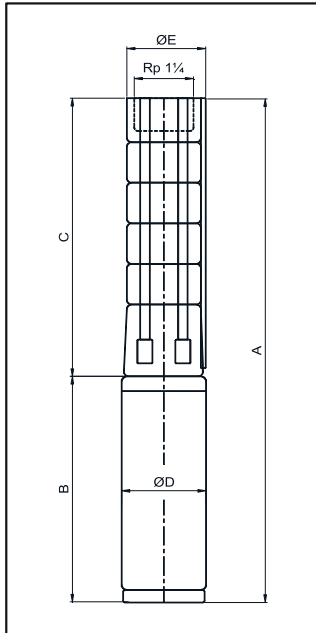

E = Maximum Dia of Pump inclusive of cable guard and motor.

TECHNICAL DATA QF 5

PUMP TYPE	MOTOR		DIMENSIONS (mm)							NET WEIGHT (kg)		
	TYPE*	POWER (kW)	C	B		A		D	E	PUMP	MOTOR	
				1x230V	3x220V 3x400V	1x230V	3x220V 3x400V				1x230V	3x220V 3x400V
QF 5 - 6	PREMIUM 100	0.37	363	242	271	605	634	95	97	5.4	10	11
QF 5 - 9	PREMIUM 100	0.55	426	291	271	717	697	95	97	6.0	11	11
QF 5 - 12	PREMIUM 100	0.75	489	291	291	780	780	95	97	6.7	11	12
QF 5 - 15	PREMIUM 100	1.1	552	339	339	891	891	95	97	7.4	15	15
QF 5 - 18	PREMIUM 100	1.1	615	339	339	954	954	95	97	8.0	15	15
QF 5 - 22	PREMIUM 100	1.5	699	404	404	1103	1103	95	97	8.9	17	17
QF 5 - 25	PREMIUM 100	1.5	762	404	404	1166	1166	95	97	9.5	17	17
QF 5 - 29	PREMIUM 100	2.2	846	538	538	1384	1384	95	97	10.4	24	24
QF 5 - 33	PREMIUM 100	2.2	930	538	538	1468	1468	95	97	11.3	24	24
QF 5 - 39	PREMIUM 100	3.0	1271	690	578	1961	1849	95	97	12.6	31	26
QF 5 - 45	PREMIUM 100	3.0	1491	690	578	2181	2069	95	97	17.9	31	26
QF 5 - 52	PREMIUM 100	4.0	1676	690	690	2366	2366	95	97	20.3	31	31
QF 5 - 60	PREMIUM 100	4.0	1888	690	690	2578	2578	95	97	23.1	31	31
QF 5 - 52	MATASF 150	4.0	1728	-	699	-	2427	145	145	20.3	-	51
QF 5 - 60	MATASF 150	4.0	1940	-	699	-	2639	145	145	23.1	-	51

* Motor type may change as per requirement .

PERFORMANCE TABLE QF 5

QF-5					DISCHARGE (Q)														
					m ³ /h		0	1	1.4	1.8	2	2.4	2.8	3.4	4	4.4			
MODEL	CONNE-CTION	MATERIAL CODE		MOTOR RATING		l/min.		TOTAL HEAD IN (m)											
		(4X4)	(6X4)	[kW]	[HP]	1~	3~	0	16.7	23.4	30.1	33.4	40.1	46.8	56.8	66.8	73.5		
QF 5-6	RP 1 1/4	9000002539	-	0.37	0.5	2.9	1.4	38	35	34	32	31	30	27	22	15	12		
QF 5-9		9000002542	-	0.55	0.75	4	2.2	57	54	51	49	47	45	41	33	23	19		
QF 5-12		9000002524	-	0.75	1	5.5	2.3	76	70	68	65	64	60	55	45	31	26		
QF 5-15		9000002525	-	1.1	1.5	8.2	3.4	95	87	85	82	80	76	70	57	40	33		
QF 5-18		9000002526	-	1.1	1.5	8.2	3.4	113	105	101	97	95	89	82	67	46	38		
QF 5-22		9000002527	-	1.5	2	10.2	4.2	139	129	125	120	117	110	101	83	57	47		
QF 5-25		9000002529	-	1.5	2	10.2	4.2	157	145	140	135	131	124	113	92	63	52		
QF 5-29		9000002530	-	2.2	3	14	5.5	184	171	166	159	156	147	136	111	78	65		
QF 5-33		9000002534	-	2.2	3	14	5.5	209	194	187	180	176	166	152	125	87	72		
QF 5-39		9000002535	-	3	4	-	7.9	246	230	223	216	212	201	188	160	120	105		
QF 5-45		9000002536	-	3	4	-	7.9	283	264	255	247	242	229	214	181	135	118		
QF 5-52		9000002538	9000013541	4	5.5	-	9.6	328	308	298	289	283	269	251	214	161	141		
QF 5-60		9000002540	9000013542	4	5.5	-	9.6	377	350	341	330	323	307	286	242	182	158		

PERFORMANCE CURVE



SUBMERSIBLE PUMP QF 6

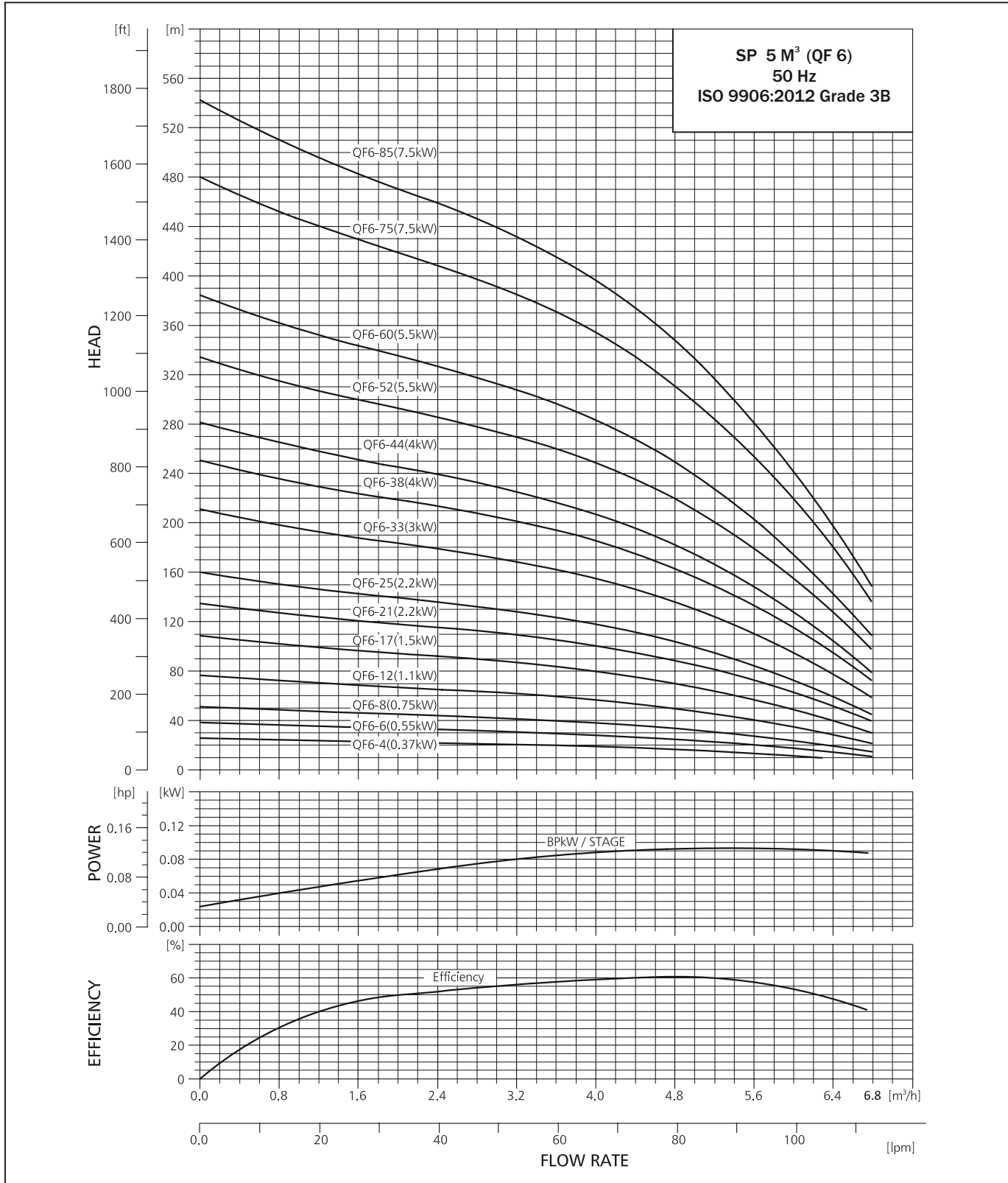

SUBMERSIBLE PUMP QF 6

DIMENSIONS AND WEIGHTS

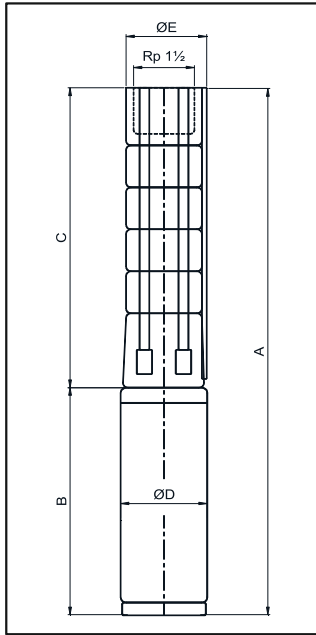

TECHNICAL DATA QF 6

PUMP TYPE	MOTOR		DIMENSIONS (mm)							NET WEIGHT (kg)		
	TYPE*	POWER (kW)	C	B		A		D	E	PUMP	MOTOR	
				1x230V	3x220V 3x400V	1x230V	3x220V 3x400V				1x230V	3x220V 3x400V
QF 6 -4	PREMIUM 100	0.37	321	242	271	563	592	95	97	5	10	11
QF 6 -6	PREMIUM 100	0.55	363	291	271	654	634	95	97	5.4	11	11
QF 6 -8	PREMIUM 100	0.75	405	291	291	696	696	95	97	5.8	11	12
QF 6 -12	PREMIUM 100	1.1	489	339	339	828	828	95	97	6.7	15	15
QF 6 -17	PREMIUM 100	1.5	594	404	404	998	998	95	97	7.8	17	17
QF 6 -21	PREMIUM 100	2.2	678	538	538	1216	1216	95	97	8.7	24	24
QF 6 -25	PREMIUM 100	2.2	762	538	538	1300	1300	95	97	9.5	24	24
QF 6 -33	PREMIUM 100	3	930	690	578	1620	1508	95	97	11.3	31	26
QF 6 -38	PREMIUM 100	4	1035	690	690	1725	1725	95	97	12.4	31	31
QF 6 -44	PREMIUM 100	4	1465	690	690	2155	2155	95	97	17.5	31	31
QF 6 -52	PREMIUM 100	5.5	1676	-	767	-	2443	95	97	20.3	-	35
QF 6 -60	PREMIUM 100	5.5	1888	-	767	-	2655	95	97	23.1	-	35
QF 6 -75	PREMIUM 100	7.5	2505	-	825	-	3330	95	97	28.2	-	38
QF 6 -85	PREMIUM 100	7.5	2770	-	825	-	3595	95	97	31.7	-	38
QF 6 -52	MATASF 150	5.5	1728	-	699	-	2427	145	145	21.7	-	51
QF 6 -60	MATASF 150	5.5	1940	-	699	-	2639	145	145	24.5	-	51
QF 6 -75	MATASF 150	7.5	2580	-	719	-	3299	145	145	29.6	-	54
QF 6 -85	MATASF 150	7.5	2845	-	719	-	3564	145	145	33.1	-	54

E = Maximum diameter of pump inclusive of cable guard & motor.

* Motor type may change as per requirement .

QF 6 -75 to QF 2-85 are mounted in sleeve for Rp 1½" connection and with max. diameter 108 mm.

PERFORMANCE TABLE QF 6

QF-6				DISCHARGE (Q)																	
				m ³ /h	0	1	1.4	1.8	2	2.4	2.8	3.4	4	4.4	5	6	6.7				
				l/min.	0	16.7	23.4	30.1	33.4	40.1	46.8	56.8	66.8	73.5	83.5	100.2	111.6				
MODEL	CONNE- -TION	MATERIAL CODE		MOTOR RATING		1~		TOTAL HEAD IN (m)													
		4x4	6x4	[kW]	[HP]	[A]	[A]														
QF 6-4	RP 1 1/4	9000002563	-	0.37	0.5	2.9	1.4	26	24	23	23	22	22	21	20	19	18	16	11	9	
QF 6-6		9000002567	-	0.55	0.75	4	2.2	38	36	35	34	33	33	32	30	28	26	24	17	11	
QF 6-8		9000002573	-	0.75	1	5.5	2.3	51	48	47	46	45	44	43	40	38	36	32	23	15	
QF 6-12		9000002553	-	1.1	1.5	8.2	3.4	77	72	70	68	67	65	63	60	56	54	47	35	23	
QF 6-17		9000002554	-	1.5	2	10.2	4.2	109	100	97	96	94	92	90	85	80	75	67	49	32	
QF 6-21		9000002557	-	2.2	3	14	5.5	135	126	122	120	118	115	112	106	100	95	85	63	42	
QF 6-25		9000002558	-	2.2	3	14	5.5	160	150	145	141	139	135	131	125	118	112	99	72	48	
QF 6-33		9000002561	-	3	4	-	7.9	211	195	190	186	183	179	173	166	155	148	130	95	62	
QF 6-38		9000002562	9000011562	4	5.5	-	9.6	250	233	229	221	219	215	209	199	186	177	157	115	76	
QF 6-44		9000002564	9000011577	4	5.5	-	9.6	281	260	257	250	245	240	232	220	207	195	174	127	84	
QF 6-52		9000002565	9000002566	5.5	7.5	-	13.6	334	310	302	296	293	285	280	267	249	238	210	155	110	
QF 6-60		9000002568	9000002569	5.5	7.5	-	13.6	384	360	345	339	335	325	319	303	283	269	238	175	130	
QF 6-75		SLEEVE	-	9000014918	7.5	10	-	-	480	450	431	424	418	405	397	379	353	337	300	212	163
QF 6-85		-	-	9000002575	7.5	10	-	-	544	510	488	480	473	459	450	430	400	382	340	240	185

PERFORMANCE CURVE



SUBMERSIBLE PUMP QF 8

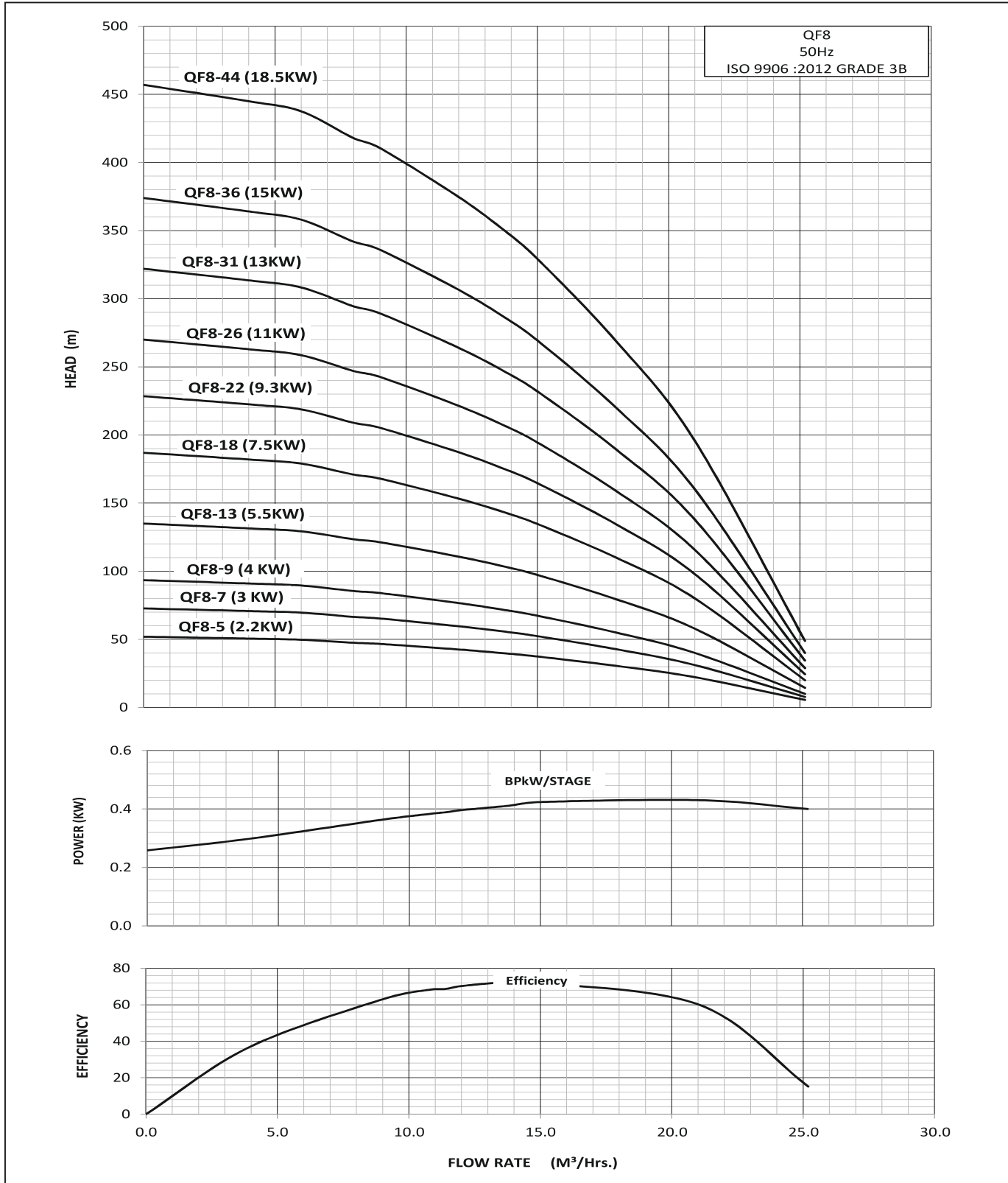

TECHNICAL DATA



SUBMERSIBLE PUMP QF 8

DIMENSIONS AND WEIGHTS

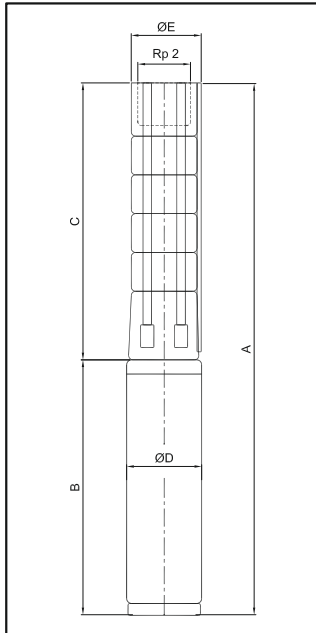

E = Maximum diameter of pump inclusive of cable guard & motor.

TECHNICAL DATA QF 8

PUMP TYPE	MOTOR		DIMENSIONS (mm)								NET WEIGHT (kg)		
	TYPE*	POWER (kW)	C	B		A		D	E*	E**	PUMP	MOTOR	
				1x230V	3x220V 3x400V	1x230V	3x220V 3x400V					1x230V	3x220V 3x400V
QF8 5	SML 150	2.2	579	555	520	1134	1099	145	145	-	13.2	34	30
QF8 7	SML 150	3	700	645	555	1345	1255	145	145	-	15.8	42	34
QF8 9	SML 150	4	821	645	555	1466	1376	145	145	-	18.4	42	34
QF8 13	SML 150	5.5	1063	680	595	1743	1658	145	-	145	23.6	46	37
QF8 18	SML 150	7.5	1365	-	645	-	2010	145	-	145	30.1	-	42
QF8 22	SML 150	9.3	1607	-	680	-	2287	145	-	145	35.3	-	46
QF8 26	SML 150	11	1849	-	705	-	2554	145	-	145	40.5	-	47
QF8 31	SML 150	13	2170	-	817	-	2987	145	-	145	47	-	60
QF8 36	SML 150	15	2472	-	820	-	3292	145	-	145	54	-	61
QF8 44	SML 150	18.5	2956	-	910	-	3866	145	-	145	64.5	-	68

*Maximum diameter of pump with one motor cable
 * *Maximum diameter of pump with two motor cable
 Motor type may change as per requirement

PERFORMANCE TABLE QF 8

QF-8			DISCHARGE (Q)									
			m ³ /h	0	6	8	9	12	14	21	25	
			l/min.	0	100	133	150	200	230	350	420	
MODEL	CONNECTION	MATERIAL CODE (6x6)	MOTOR RATING		TOTAL HEAD IN (m)							
			[kW]	[HP]								
QF8 - 5	Rp 2"	9000030932	2.2	3	52	50	48	47	43	40	22	6
QF8 - 7		9000030479	3	4	73	70	67	65	60	56	31	8
QF8 - 9		9000030480	4	5.5	93	90	86	84	77	71	40	10
QF8 - 13		9000030933	5.5	7.5	135	130	124	121	111	103	58	14
QF8 - 18		9000030934	7.5	10	187	180	171	168	153	143	80	20
QF8 - 22		9000030935	9.3	12.5	228	220	209	205	187	175	98	24
QF8 - 26		9000030936	11	15	270	260	247	243	221	206	116	29
QF8 - 31		9000030937	13	17.5	322	310	295	289	264	246	138	34
QF8 - 36		9000030938	15	20	374	360	342	336	307	286	160	40
QF8 - 44		9000030939	18.5	25	457	440	418	411	375	349	196	49

PERFORMANCE CURVE



SUBMERSIBLE PUMP NGP 12

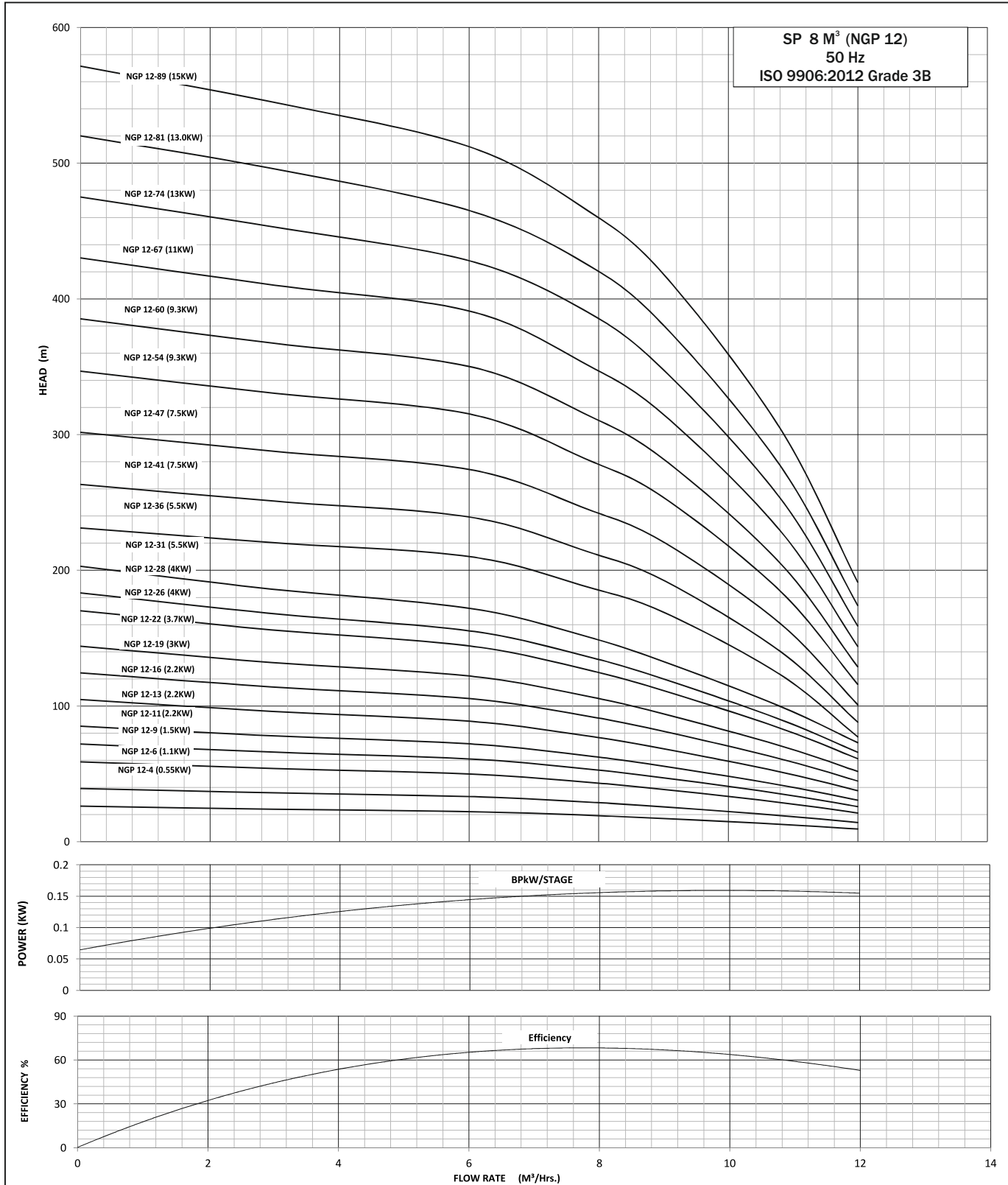

SUBMERSIBLE PUMP NGP 12

DIMENSIONS AND WEIGHTS

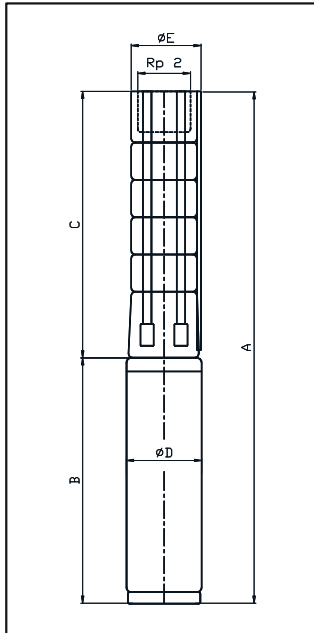

E = Maximum diameter of pump inclusive of cable guard & motor.

TECHNICAL DATA NGP 12

PUMP TYPE	MOTOR		DIMENSIONS (mm)						NET WEIGHT (kg)			
	TYPE	POWER (kW)	C	B		A		D	E	PUMP	MOTOR	
				1X230V	3X220V 3X400V	1X230V	3X220V 3X400V				1X230V	3X220V 3X400V
NGP 12 - 4	PREMIUM 100	0.55	418	291	291	709	709	95	97	5.8	10	11
NGP 12 - 6	PREMIUM 100	1.1	518	339	339	857	857	95	97	7	15	15
NGP 12 - 9	PREMIUM 100	1.5	668	404	404	1072	1072	95	97	8.8	17	17
NGP 12 - 11	PREMIUM 100	2.2	768	538	538	1306	1306	95	97	10	24	24
NGP 12 - 13	PREMIUM 100	2.2	868	538	538	1406	1406	95	97	11.2	24	24
NGP 12 - 16	PREMIUM 100	2.2	1018	538	538	1556	1556	95	97	13	24	24
NGP 12 - 19	PREMIUM 100	3	1168	690	578	1858	1746	95	97	14.8	31	26
NGP 12 - 22	PREMIUM 100	3.7	1318	690	690	2008	2008	95	97	16.6	31	31
NGP 12 - 26	PREMIUM 100	4	1518	-	690	-	2208	95	97	19.1	31	31
NGP 12 - 28	PREMIUM 100	4	1618	-	690	-	2308	95	97	20.3	31	31
NGP 12 - 36	PREMIUM 100	5.5	2018	-	767	-	2785	95	97	25	-	35
NGP 12 - 28	MATASF 150	4	1669	-	699	-	2368	145	145	22.5	-	51
NGP 12 - 31	MATASF 150	5.5	1819	-	699	-	2518	145	145	24.4	-	51
NGP 12 - 36	MATASF 150	5.5	2069	-	699	-	2768	145	145	27.6	-	51
NGP 12 - 41	MATASF 150	7.5	2319	-	719	-	3038	145	145	30.8	-	54
NGP 12 - 47	MATASF 150	7.5	2619	-	719	-	3338	145	145	34.6	-	54
NGP 12 - 54	MATASF 150	9.3	2969	-	749	-	3718	145	145	39	-	57
NGP 12 - 60	MATASF 150	9.3	3269	-	749	-	4018	145	145	42.8	-	57
NGP 12 - 67	MATASF 150	11	3619	-	779	-	4398	145	145	47.3	-	59
NGP 12 - 74	MATASF 150	13	3969	-	829	-	4798	145	145	51.7	-	64
NGP 12 - 81	MATASF 150	13	4319	-	829	-	5148	145	145	56.2	-	64
NGP 12 - 89	MATASF 150	15	4719	-	874	-	5593	145	145	61.3	-	70

* Maximum diameter of pump with one motor cable.

PERFORMANCE TABLE NGP 12

NGP12 - 50HZ		DISCHARGE (Q)									
		M3/h	0	3	6	8	9	11	12		
		l/min.	0	50	100	130	150	180	200		
MODEL	MATERIAL CODE		MOTOR RATING		TOTAL HEAD (m)						
	(4X4)	(6X4)	[kW]	[HP]							
NGP 12 - 4	9000023238		0.55	0.75	26	24	22	20	17	13	9
NGP 12 - 6	9000023239		1.1	1.5	39	36	33	29	26	19	14
NGP 12 - 9	9000023240		1.5	2	59	54	50	44	39	29	21
NGP 12 - 11	9000023241		2.2	3	72	66	61	54	47	35	26
NGP 12 - 13	9000023242		2.2	3	85	78	72	63	56	42	31
NGP 12 - 16	9000023243		2.2	3	105	96	89	78	69	52	38
NGP 12 - 19	9000023244		3	4	124	114	105	93	81	61	45
NGP 12 - 22	9000023245		3.7	5	144	132	122	107	94	71	52
NGP 12 - 26	9000023246		4	5.5	170	156	144	127	111	84	61
NGP 12 - 28	9000023880	9000030149	4	5.5	183	168	155	137	120	90	66
NGP 12 - 31		9000023764	5.5	7.5	203	186	172	151	133	100	73
NGP 12 - 36	9000030345	9000029440	5.5	7.5	231	220	210	188	173	123	77
NGP 12 - 41		9000023249	7.5	10	263	251	239	214	197	140	88
NGP 12 - 47		9000029952	7.5	10	302	288	274	245	226	161	101
NGP 12 - 54		9000029953	9.3	12.5	347	331	315	282	259	185	116
NGP 12 - 60		9000029954	9.3	12.5	385	367	350	313	288	205	129
NGP 12 - 67		9000029955	11	15	430	410	391	349	322	229	144
NGP 12 - 74		9000029956	13	17.5	475	453	432	386	355	253	159
NGP 12 - 81		9000029957	13	17.5	520	496	473	422	389	277	174
NGP 12 - 89		9000029958	15	20	571	545	519	464	427	305	191

PERFORMANCE CURVE



SUBMERSIBLE PUMP QF 12

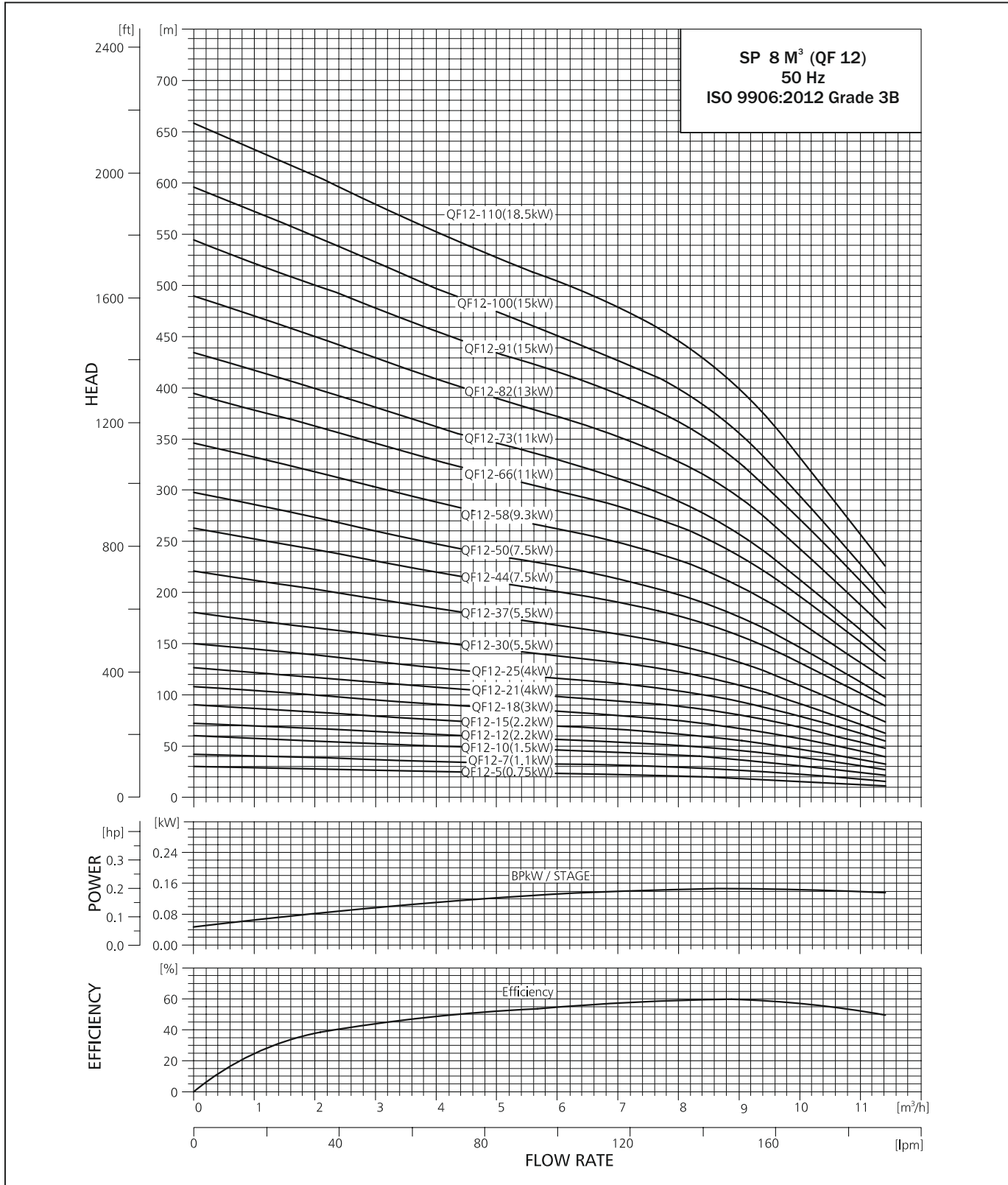

TECHNICAL DATA



SUBMERSIBLE PUMP QF 12

DIMENSIONS AND WEIGHTS

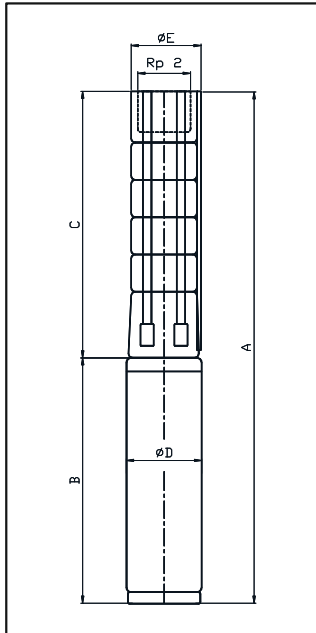

E = Maximum diameter of pump inclusive of cable guard & motor.

QF12-58 to QF12-110 are mounted in sleeve for R 2" connection

TECHNICAL DATA QF 12

PUMP TYPE	MOTOR		DIMENSIONS (mm)							NET WEIGHT (kg)		
	TYPE	POWER (kW)	C	B		A		D	E	PUMP	MOTOR	
				1x230V	3x220V 3x400V	1x230V	3x220V 3x400V				1x230V	3x220V 3x400V
QF12 - 5	PREMIUM 100	0.75	448	291	291	739	739	95	97	5.8	11	12
QF12 - 7	PREMIUM 100	1.1	532	339	339	871	871	95	97	6.8	15	15
QF12 - 10	PREMIUM 100	1.5	658	404	404	1062	1062	95	97	8.2	17	17
QF12 - 12	PREMIUM 100	2.2	742	538	538	1280	1280	95	97	9.2	24	24
QF12 - 15	PREMIUM 100	2.2	868	538	538	1406	1406	95	97	10.6	24	24
QF12 - 18	PREMIUM 100	3	994	690	578	1684	1572	95	97	12.1	31	26
QF12 - 21	PREMIUM 100	4	1120	690	690	1810	1810	95	97	13.5	31	31
QF12 - 25	PREMIUM 100	4	1288	690	690	1978	1978	95	97	15.5	31	31
QF12 - 30	PREMIUM 100	5.5	1498	-	767	-	2265	95	97	17.9	-	35
QF12 - 37	PREMIUM 100	5.5	1792	-	767	-	2559	95	97	21.2	-	35
QF12 - 44	PREMIUM 100	7.5	2086	-	825	-	2911	95	97	24.6	-	38
QF12 - 50	PREMIUM 100	7.5	2338	-	825	-	3163	95	97	27.5	-	38
QF12 - 30	MATASF 150	5.5	1550	-	699	-	2249	145	145	19.7	-	51
QF12 - 37	MATASF 150	5.5	1844	-	699	-	2543	145	145	23.2	-	51
QF12 - 44	MATASF 150	7.5	2138	-	719	-	2857	145	145	26.6	-	54
QF12 - 50	MATASF 150	7.5	2390	-	719	-	3109	145	145	29.5	-	54
QF12 - 58	MATASF 150	9.3	2726	-	749	-	3475	145	145	33.4	-	57
QF12 - 66	MATASF 150	11	3062	-	779	-	3841	145	145	37.7	-	59
QF12 - 73	MATASF 150	11	3356	-	779	-	4135	145	145	40.7	-	59
QF12 - 82	MATASF 150	13	3734	-	829	-	4563	145	145	45	-	64
QF12 - 91	MATASF 150	15	4112	-	874	-	4986	145	145	49.4	-	70
QF12 - 100	MATASF 150	15	4490	-	874	-	5364	145	145	53.8	-	70
QF12 - 110	MATASF 150	18.5	4910	-	919	-	5829	145	145	58.6	-	73

* Maximum diameter of pump with one motor cable.

PERFORMANCE TABLE QF 12

MODEL		CONNECTION		MATERIAL CODE		MOTOR RATING		DISCHARGE (Q)																								
								m ³ /h		0							1.4		2		4		6		8		9		10		11	
								l/min.		0							23.4		33.4		66.8		100.2		133.3		150		167		183.7	
								I~		3~		TOTAL HEAD IN (m)																				
								[kW]		[HP]		[A]		[A]																		
QF 12 - 5	Rp 2	9000002616	-	0.75	1.0	5.5	2.3	30	29	27	25	23	21	19	16	12																
QF 12 - 7		9000002626	-	1.1	1.5	8.2	3.4	42	40	38	35	32	29	26	22	17																
QF 12 - 10		9000002581	-	1.5	2.0	10.2	4.2	60	57	55	50	46	41	37	32	24																
QF 12 - 12		9000002585	-	2.2	3.0	14.0	5.5	72	68	66	61	57	51	46	39	31																
QF 12 - 15		9000002588	-	2.2	3.0	14.0	5.5	90	85	82	76	70	62	56	47	37																
QF 12 - 18		9000002592	-	3.0	4.0	-	7.9	108	102	99	91	84	75	67	57	45																
QF 12 - 21		9000002596	9000011469	4.0	5.5	-	9.6	127	120	117	107	99	89	80	68	53																
QF 12 - 25		9000002600	9000008265	4.0	5.5	-	9.6	150	142	139	126	116	104	94	79	62																
QF 12 - 30		9000002606	9000002607	5.5	7.5	-	13.6	180	170	165	151	138	123	110	92	71																
QF 12 - 37		9000002609	9000002610	5.5	7.5	-	13.6	221	210	202	184	168	148	132	110	84																
QF 12 - 44		-	9000002614	7.5	10.0	-	-	264	246	238	220	202	185	167	141	106																
QF 12 - 50		-	9000002619	7.5	10.0	-	-	300	279	270	250	230	210	190	160	120																
QF 12 - 58		Sleeve	-	9000012044	9.3	12.5	-	-	348	324	314	290	266	244	220	186	140															
QF 12 - 66			-	9000002624	11	15.0	-	-	396	369	357	330	303	277	250	211	159															
QF 12 - 73	-		9000002627	11	15.0	-	-	438	408	395	365	335	307	277	234	176																
QF 12 - 82	-		9000002629	13.0	17.5	-	-	492	458	443	410	376	345	311	263	197																
QF 12 - 91	-		9000002631	15.0	20.0	-	-	546	509	492	455	418	383	345	292	219																
QF 12 - 100	-		9000002582	15.0	20.0	-	-	600	559	541	500	459	420	379	320	241																
QF 12 - 110	-		9000013726	18.5	25.0	-	-	660	615	595	550	505	462	417	352	265																

PERFORMANCE CURVE

SUBMERSIBLE PUMP QF 20

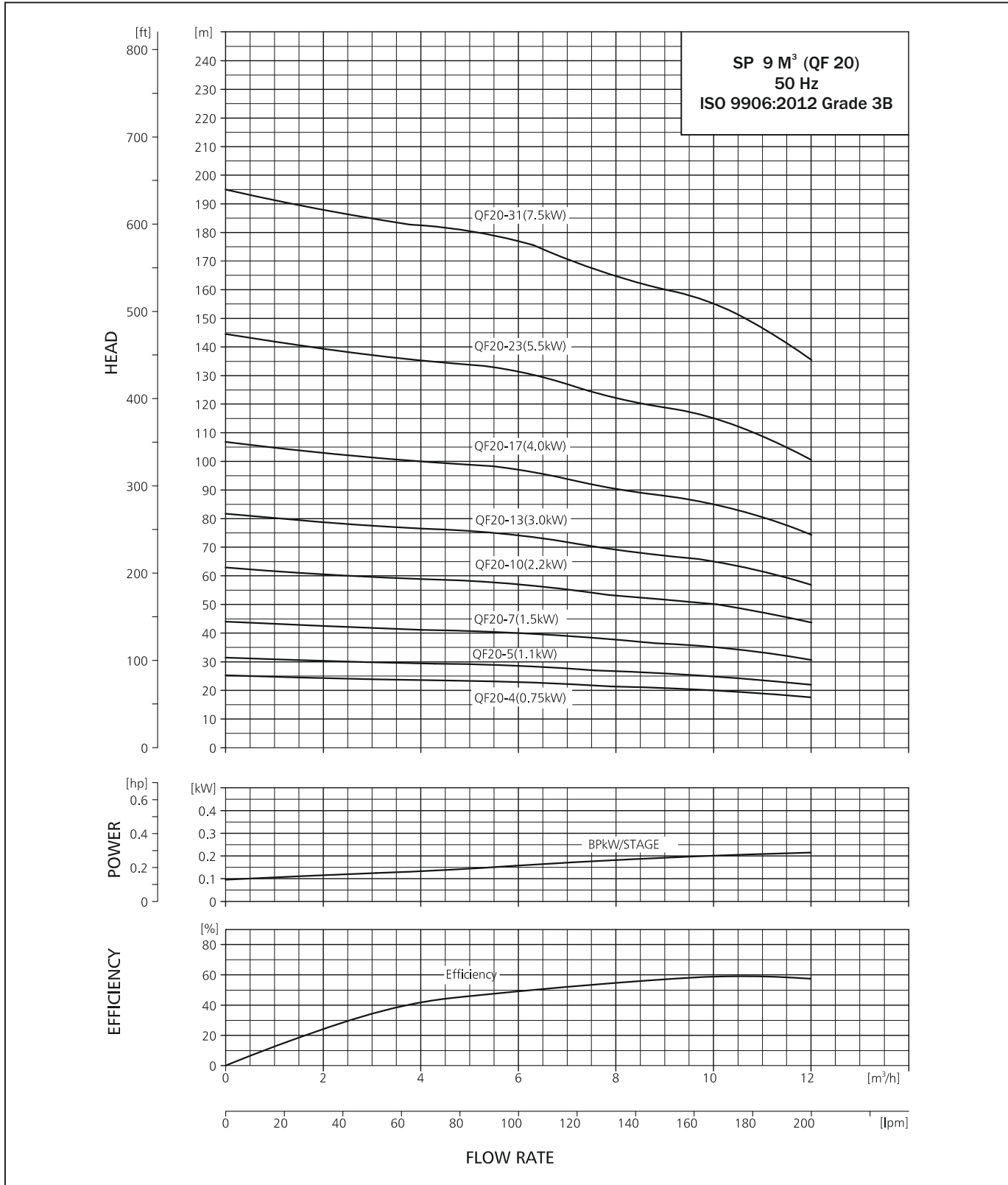

SUBMERSIBLE PUMP QF 20

DIMENSIONS AND WEIGHTS

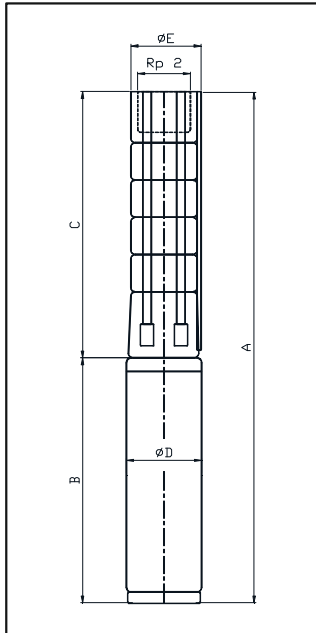

E = Maximum diameter of pump inclusive of cable guard & motor.

TECHNICAL DATA QF 20

PUMP TYPE	MOTOR		DIMENSIONS (mm)							NET WEIGHT (kg)		
	TYPE	POWER (kW)	C	B		A		D	E	PUMP	MOTOR	
				1x230V	3x220V 3x400V	1x230V	3x220V 3x400V				1x230V	3x220V 3x400V
QF 20 - 4	PREMIUM 100	1.1	495	339	339	834	834	95	97	6.5	15	15
QF 20 - 5	PREMIUM 100	1.1	560	339	339	899	899	95	97	7.2	15	15
QF 20 - 7	PREMIUM 100	1.5	690	404	404	1094	1094	95	97	8.5	17	17
QF 20 - 10	PREMIUM 100	2.2	885	538	538	1423	1423	95	97	10.4	24	24
QF 20 - 13	PREMIUM 100	3.0	1080	690	578	1770	1658	95	97	12.4	31	26
QF 20 - 17	PREMIUM 100	4.0	1340	690	690	2030	2030	95	97	15.1	31	31
QF 20 - 23	PREMIUM 100	5.5	1730	-	767	-	2497	95	97	19.0	-	35
QF 20 - 31	PREMIUM 100	7.5	2250	-	825	-	3075	95	97	24.3	-	38
QF 20 - 23	MATASF 150	5.5	1782	-	699	-	2481	145	145	19.7	-	51
QF 20 - 31	MATASF 150	7.5	2302	-	719	-	3021	145	145	25.0	-	54

* Motor type may change as per requirement .

PERFORMANCE TABLE QF 20

QF-20				DISCHARGE (Q)								
				m ³ /h	0	2	4	6	8	10	12	
				l/min.	0	33.4	66.8	100.1	133.6	167	200.1	
MODEL	CONNECTION	MATERIAL CODE		MOTOR RATING		TOTAL HEAD IN (m)						
		4x4	6x4	[kW]	[HP]							
QF 20 - 4	Rp2"	9000002644	-	0.75	1	27	26	25	24	22	20	18
QF 20 - 5		9000011470	-	1.1	1.5	34	33	31	30	28	25	23
QF 20 - 7		9000011471	-	1.5	2	47	46	44	42	39	35	32
QF 20 - 10		9000011862	-	2.2	3	68	65	63	60	55	50	45
QF 20 - 13		9000011473	-	3	4	88	85	81	78	72	65	59
QF 20 - 17		9000011861	-	4	5.5	115	111	106	102	94	85	77
QF 20 - 23		9000011863	-	5.5	7.5	155	150	144	138	127	115	104
QF 20 - 31		9000011864	9000016485	7.5	10	209	202	194	186	171	155	140

PERFORMANCE CURVE

SUBMERSIBLE PUMP QF 25

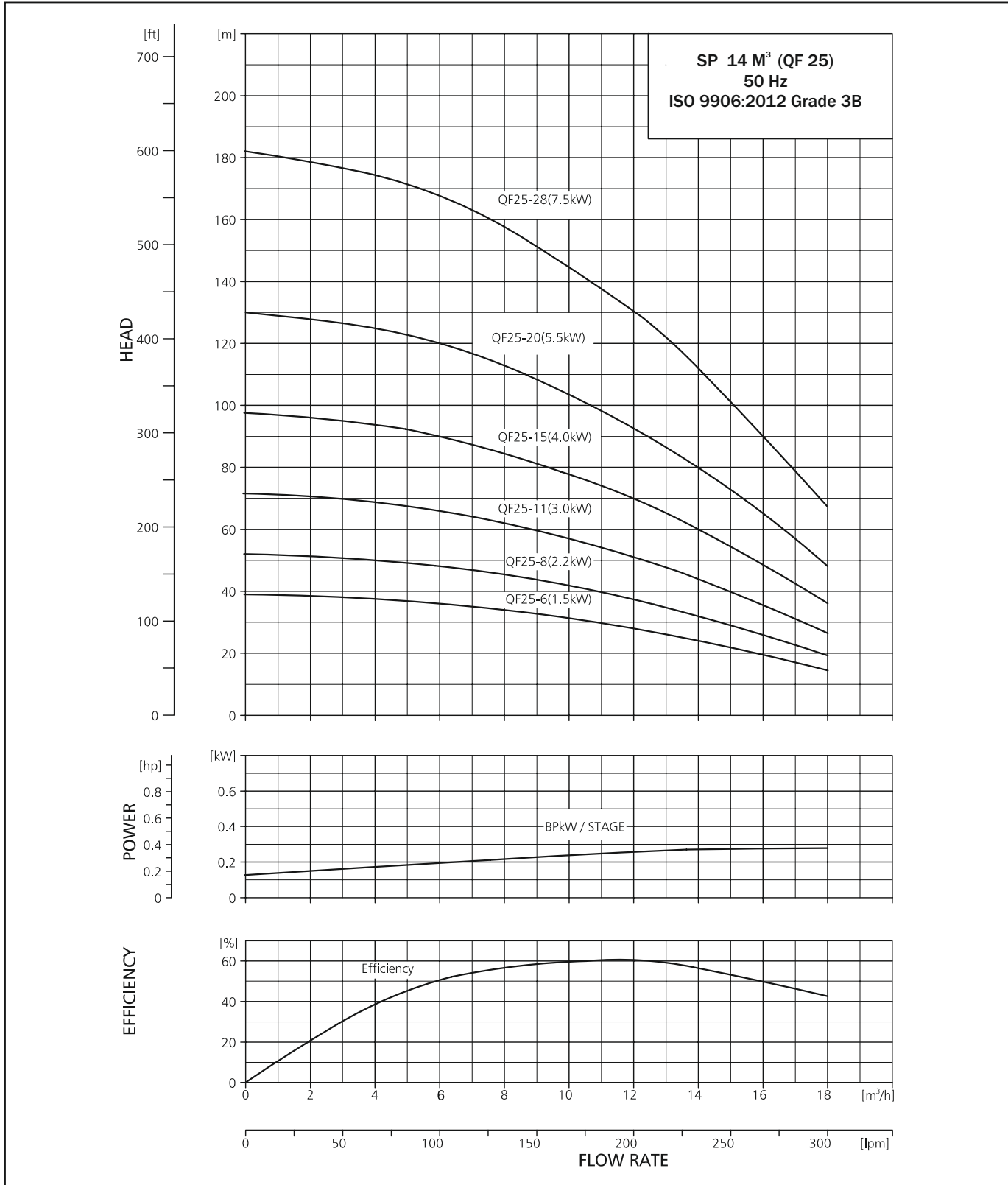

TECHNICAL DATA

SUBMERSIBLE PUMP QF 25

DIMENSIONS AND WEIGHTS

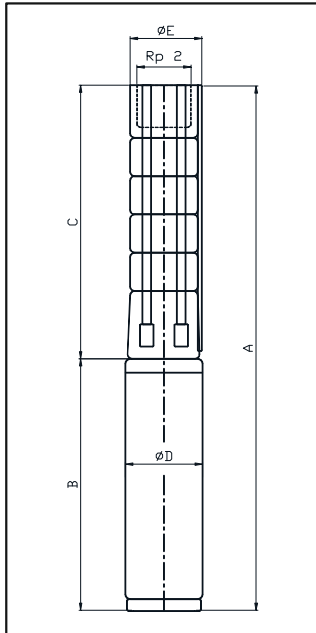

E = Maximum diameter of pump inclusive of cable guard & motor.

TECHNICAL DATA QF 25

PUMP TYPE	MOTOR		DIMENSIONS (mm)							NET WEIGHT (kg)		
	TYPE	POWER (kW)	C	B		A		D	E	PUMP	MOTOR	
				1x230V	3x220V 3x400V	1x230V	3x220V 3x400V				1x230V	3x220V 3x400V
QF 25-6	PREMIUM 100	1.5	625	404	404	1029	1029	95	97	7.8	17	17
QF 25-8	PREMIUM 100	2.2	755	538	538	1293	1293	95	97	9.1	24	24
QF 25-11	PREMIUM 100	3.0	950	690	578	1640	1528	95	97	11.1	31	26
QF 25-15	PREMIUM 100	4.0	1210	690	690	1900	1900	95	97	13.7	31	31
QF 25-20	PREMIUM 100	5.5	1535	-	767	-	2302	95	97	17.0	-	35
QF 25-28	PREMIUM 100	7.5	2055	-	825	-	2880	95	97	22.3	-	38
QF 25-20	MATASF 150	5.5	1587	-	699	-	2286	145	145	17.7	-	51
QF 25-28	MATASF 150	7.5	2107	-	719	-	2826	145	145	23.0	-	54

* Motor type may change as per requirement .

PERFORMANCE TABLE QF 25

QF-25				DISCHARGE (Q)								
				m ³ /h		0	6	9	11	12	14	18
				l/min.		0	100.2	150	183.7	200.4	233.8	300.6
MODEL	CONNECTION	MATERIAL CODE		MOTOR RATING		TOTAL HEAD IN (m)						
		4x4	6x4	[kW]	[HP]							
QF 25 - 6	Rp 2"	9000011848	-	1.5	2	39	36	32	29	28	24	14
QF 25 - 8		9000008189	-	2.2	3	52	48	42	39	37	32	19
QF 25 - 11		9000011850	-	3	4	72	66	58	54	51	44	26
QF 25 - 15		9000011852	-	4	5.5	98	90	80	74	70	60	36
QF 25 - 20		9000011854	9000012090	5.5	7.5	130	120	106	98	93	80	48
QF 25 - 28		9000011856	9000013213	7.5	10	182	168	148	137	131	112	67

PERFORMANCE CURVE



SUBMERSIBLE PUMP QF 10

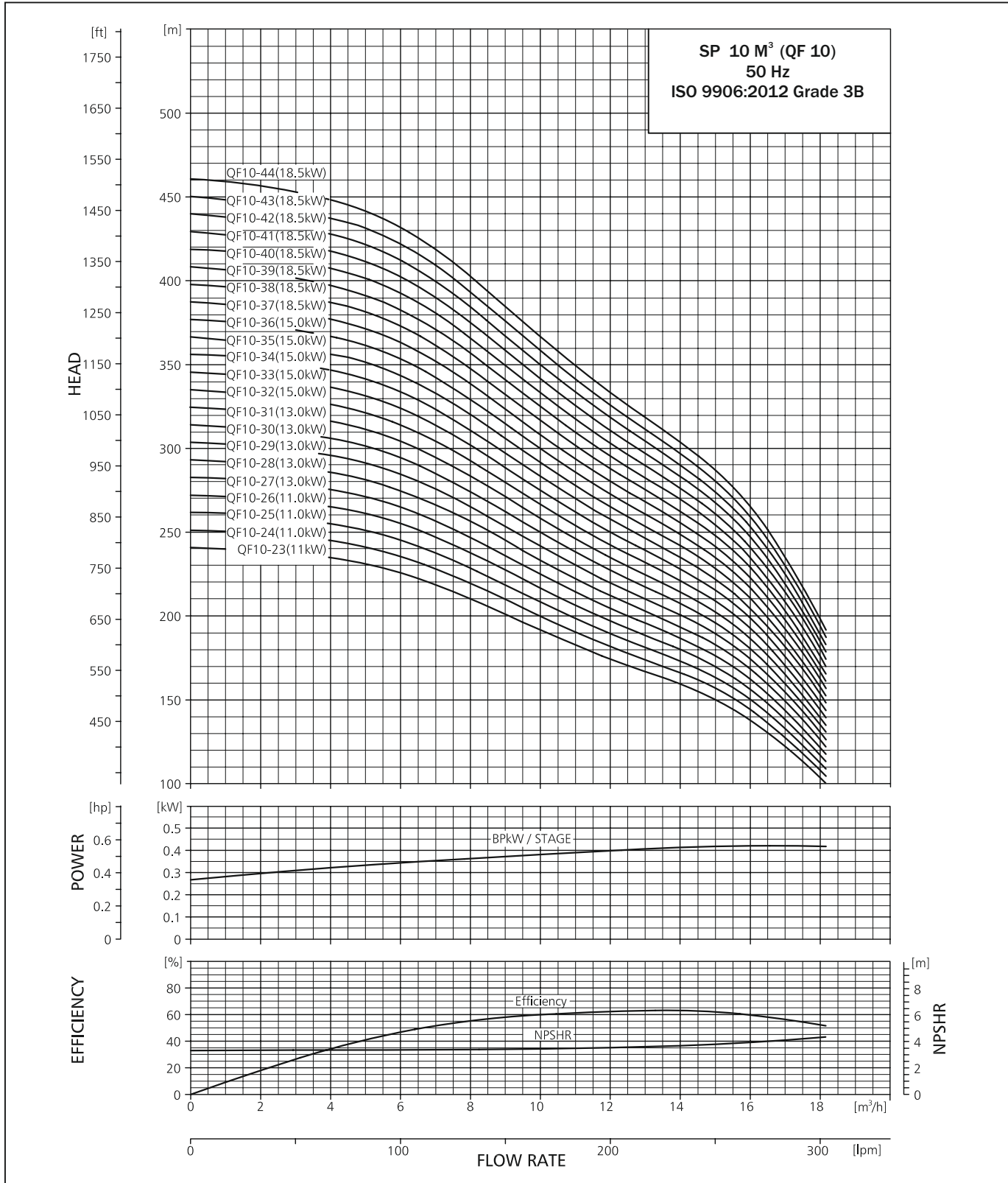

PERFORMANCE CURVE



SUBMERSIBLE PUMP QF 10

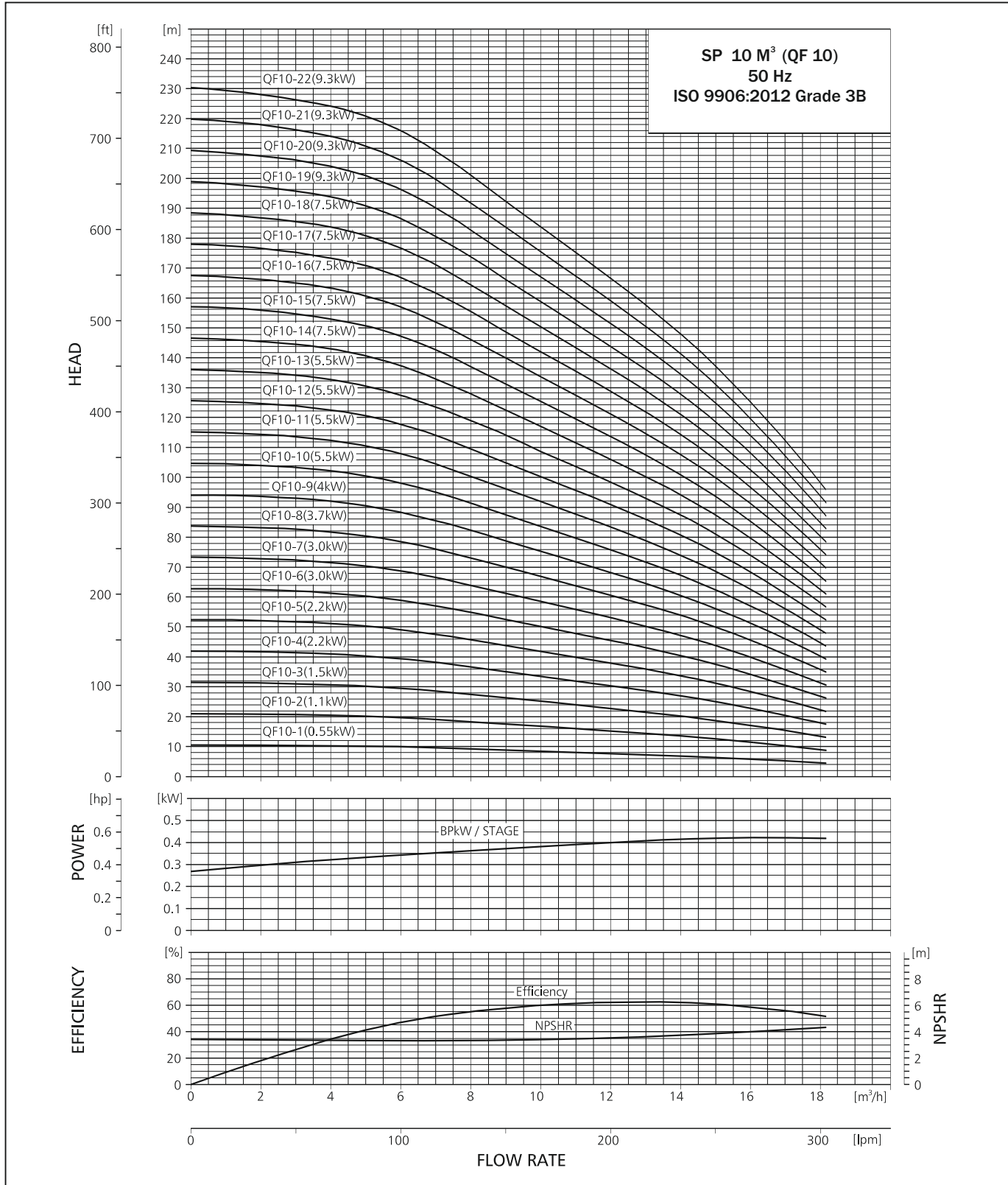

SUBMERSIBLE PUMP QF 10

DIMENSIONS AND WEIGHTS

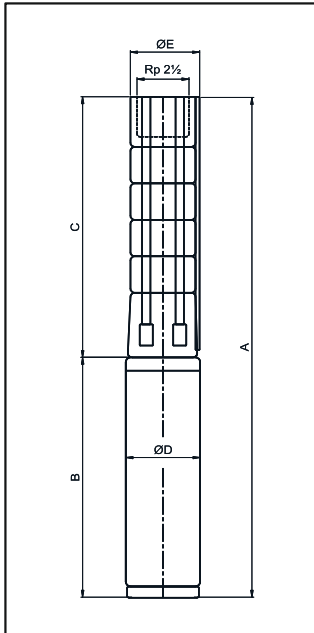

E = Maximum diameter of pump inclusive of cable guard & motor.

TECHNICAL DATA QF 10

PUMP TYPE	MOTOR		DIMENSIONS (mm)							NET WEIGHT (kg)			
	TYPE	POWER (kW)	C	B		A		D	E*	E**	PUMP	MOTOR	
				1x230V	3x220V 3x400V	1x230V	3x220V 3x400V					1x230V	3x220V 3x400V
QF 10-1	PREMIUM 100	0.55	321	291	271	612	592	95	128	-	6.7	11	11
QF 10-2	PREMIUM 100	1.1	382	339	339	721	721	95	128	-	8.0	15	15
QF 10-3	PREMIUM 100	1.5	442	404	404	846	846	95	128	-	9.3	17	17
QF 10-4	PREMIUM 100	2.2	503	538	538	1041	1041	95	128	-	10.6	24	24
QF 10-5	PREMIUM 100	2.2	563	538	538	1101	1101	95	128	-	11.9	24	24
QF 10-6	PREMIUM 100	3.0	624	690	578	1314	1202	95	128	-	13.2	31	26
QF 10-7	PREMIUM 100	3.0	684	690	578	1374	1262	95	128	-	14.5	31	26
QF 10-8	PREMIUM 100	4.0	745	690	690	1435	1435	95	128	-	15.8	31	26
QF 10-9	PREMIUM 100	4.0	805	690	690	1495	1495	95	128	-	17.1	31	31
QF 10-10	PREMIUM 100	5.5	866	-	767	-	1633	95	128	-	18.4	-	35
QF 10-11	PREMIUM 100	5.5	926	-	767	-	1693	95	128	-	19.7	-	35
QF 10-12	PREMIUM 100	5.5	987	-	767	-	1754	95	128	-	21	-	35
QF 10-13	PREMIUM 100	5.5	1047	-	767	-	1814	95	128	-	22.3	-	35
QF 10-14	PREMIUM 100	7.5	1108	-	825	-	1933	95	128	-	23.6	-	38
QF 10-15	PREMIUM 100	7.5	1168	-	825	-	1993	95	128	-	24.9	-	38
QF 10-16	PREMIUM 100	7.5	1229	-	825	-	2054	95	128	-	26.2	-	38
QF 10-17	PREMIUM 100	7.5	1289	-	825	-	2114	95	128	-	27.5	-	38
QF 10-18	PREMIUM 100	7.5	1350	-	825	-	2175	95	128	-	28.8	-	38
QF 10-12	MATASF 150	5.5	1002	-	699	-	1701	145	145	-	22.3	-	51
QF 10-13	MATASF 150	5.5	1063	-	699	-	1762	145	145	-	23.6	-	51
QF 10-14	MATASF 150	7.5	1123	-	719	-	1842	145	145	145	24.9	-	54
QF 10-15	MATASF 150	7.5	1184	-	719	-	1903	145	145	145	26.2	-	54
QF 10-16	MATASF 150	7.5	1244	-	719	-	1963	145	145	145	27.5	-	54
QF 10-17	MATASF 150	7.5	1305	-	719	-	2024	145	145	145	28.8	-	54
QF 10-18	MATASF 150	7.5	1365	-	719	-	2084	145	145	145	30.1	-	54
QF 10-19	MATASF 150	9.3	1426	-	749	-	2175	145	145	145	31.4	-	57
QF 10-20	MATASF 150	9.3	1486	-	749	-	2235	145	145	145	32.7	-	57
QF 10-21	MATASF 150	9.3	1547	-	749	-	2296	145	145	145	34	-	57
QF 10-22	MATASF 150	9.3	1607	-	749	-	2356	145	145	145	35.3	-	57
QF 10-23	MATASF 150	11.0	1668	-	779	-	2447	145	145	145	36.6	-	59
QF 10-24	MATASF 150	11.0	1728	-	779	-	2507	145	145	145	37.9	-	59
QF 10-25	MATASF 150	11.0	1789	-	779	-	2568	145	145	145	39.2	-	59
QF 10-26	MATASF 150	11.0	1849	-	779	-	2628	145	145	145	40.5	-	59
QF 10-27	MATASF 150	13.0	1910	-	829	-	2739	145	145	145	41.8	-	64
QF 10-28	MATASF 150	13.0	1970	-	829	-	2799	145	145	145	43.1	-	64
QF 10-29	MATASF 150	13.0	2031	-	829	-	2860	145	145	145	44.4	-	64
QF 10-30	MATASF 150	13.0	2109	-	829	-	2938	145	145	145	45.7	-	64
QF 10-31	MATASF 150	13.0	2170	-	829	-	2999	145	145	145	47	-	64
QF 10-32	MATASF 150	15.0	2230	-	874	-	3104	145	145	145	48.3	-	70
QF 10-33	MATASF 150	15.0	2291	-	874	-	3165	145	145	145	49.6	-	70
QF 10-34	MATASF 150	15.0	2351	-	874	-	3225	145	145	145	51.4	-	70
QF 10-35	MATASF 150	15.0	2412	-	874	-	3286	145	145	145	52.7	-	70
QF 10-36	MATASF 150	15.0	2472	-	874	-	3346	145	145	145	54	-	70
QF 10-37	MATASF 150	18.5	2533	-	919	-	3452	145	145	145	55.3	-	73
QF 10-38	MATASF 150	18.5	2593	-	919	-	3512	145	145	145	56.6	-	73
QF 10-39	MATASF 150	18.5	2654	-	919	-	3573	145	145	145	57.9	-	73
QF 10-40	MATASF 150	18.5	2714	-	919	-	3633	145	145	145	59.2	-	73
QF 10-41	MATASF 150	18.5	2775	-	919	-	3694	145	145	145	60.5	-	73
QF 10-42	MATASF 150	18.5	2835	-	919	-	3754	145	145	145	61.9	-	73
QF 10-43	MATASF 150	18.5	2896	-	919	-	3815	145	145	145	63.2	-	73
QF 10-44	MATASF 150	18.5	2956	-	919	-	3875	145	145	145	64.5	-	73

* Motor type may change as per requirement.

** Maximum diameter of pump with two motor cable.

Motor type may change as per requirement.

TECHNICAL DATA



SUBMERSIBLE PUMP QF 10

PERFORMANCE TABLE QF 10

QF-10		MOTOR RATING		DISCHARGE (Q)										
				m ³ /h		0	2	6	8	10	12	14	16	18
				l/min.		0	33.3	100	133.3	166.7	200	233.3	266.7	300
MODEL	CONNECTION	MATERIAL CODE		MOTOR RATING		TOTAL HEAD IN (m)								
		4x6	6x6	[kW]	[HP]									
QF-10-1	Rp 2 "	9000002716	-	0.55	0.75	12	11	10	9	8	8	6	5	4
QF-10-2		9000002735	-	1.1	1.5	22	21	20	18	17	15	13	11	8
QF-10-3		9000002746	-	1.5	2	31	30	29	27	25	23	19	16	12
QF-10-4		9000002757	9000002758	2.2	3	42	40	39	36	33	30	25	21	16
QF-10-5		9000002764	9000011844	2.2	3	52	50	49	46	42	38	32	27	20
QF-10-6		9000002765	9000011086	3	4	62	60	59	55	50	45	38	32	24
QF-10-7		9000002766	9000010656	3	4	73	69	68	64	59	53	44	37	28
QF-10-8		9000002767	9000002768	3.7	5	83	79	78	73	67	61	51	43	32
QF-10-9		9000013487	9000002770	4	5.5	94	89	88	82	75	68	57	48	36
QF-10-10		9000002717	9000002718	5.5	7.5	104	99	98	91	84	76	63	53	40
QF-10-11		9000002719	9000002718	5.5	7.5	114	108	107	100	92	83	70	59	44
QF-10-12		9000002720	9000002721	5.5	7.5	125	118	117	109	100	91	76	64	48
QF-10-13		9000002722	9000002723	5.5	7.5	135	128	127	118	109	98	82	69	52
QF-10-14		9000002724	9000002725	7.5	10	146	138	137	128	117	106	89	75	56
QF-10-15		9000002726	9000002727	7.5	10	156	148	147	137	125	114	95	80	60
QF-10-16		9000002728	9000002729	7.5	10	166	157	156	146	134	121	101	85	64
QF-10-17		9000002730	9000002731	7.5	10	177	167	166	155	142	129	108	91	68
QF-10-18		9000002732	9000002733	7.5	10	187	177	176	164	150	136	114	96	72
QF-10-19		-	9000002734	9.3	12.5	198	187	186	173	159	144	120	101	76
QF-10-20		-	9000002736	9.3	12.5	208	196	195	182	167	151	127	107	80
QF-10-21		-	9000002737	9.3	12.5	218	206	205	191	176	159	133	112	84
QF-10-22		-	9000002738	9.3	12.5	229	216	215	200	184	167	139	117	88
QF-10-23		-	9000002739	11	15	239	226	225	210	192	174	146	123	92
QF-10-24		-	9000002740	11	15	250	235	234	219	201	182	152	128	96
QF-10-25		-	9000002741	11	15	260	246	244	228	209	189	159	134	100
QF-10-26		-	9000002742	11	15	270	256	254	237	217	197	165	139	104
QF-10-27		-	9000002743	13	17.5	281	266	264	246	226	204	171	144	108
QF-10-28		-	9000002744	13	17.5	291	276	274	255	234	212	178	150	112
QF-10-29		-	9000002745	13	17.5	302	285	283	264	242	220	184	155	116
QF-10-30		-	9000002747	13	17.5	312	295	293	273	251	227	190	160	120
QF-10-31		-	9000002748	13	17.5	322	305	303	282	259	235	197	166	124
QF-10-32		-	9000002749	15	20	333	315	313	292	268	242	203	171	128
QF-10-33		-	9000002750	15	20	343	324	322	301	276	250	209	176	132
QF-10-34		-	9000002751	15	20	354	334	332	310	284	257	216	182	136
QF-10-35		-	9000002752	15	20	364	344	342	319	293	265	222	187	140
QF-10-36		-	9000002753	15	20	374	354	352	328	301	273	228	192	144
QF-10-37		-	9000002754	18.5	25	385	365	361	337	309	280	235	198	148
QF-10-38		-	9000002755	18.5	25	395	375	371	346	318	288	241	203	152
QF-10-39		-	9000002756	18.5	25	406	385	381	355	326	295	247	208	156
QF-10-40		-	9000002759	18.5	25	416	395	391	364	334	303	254	214	160
QF-10-41		-	9000002760	18.5	25	426	404	401	374	343	310	260	219	164
QF-10-42		-	9000002761	18.5	25	437	413	410	383	351	318	266	224	168
QF-10-43		-	9000002762	18.5	25	447	423	420	392	359	326	273	230	172
QF-10-44		-	9000002763	18.5	25	458	433	430	401	368	333	279	235	176

PERFORMANCE CURVE



SUBMERSIBLE PUMP QF 15

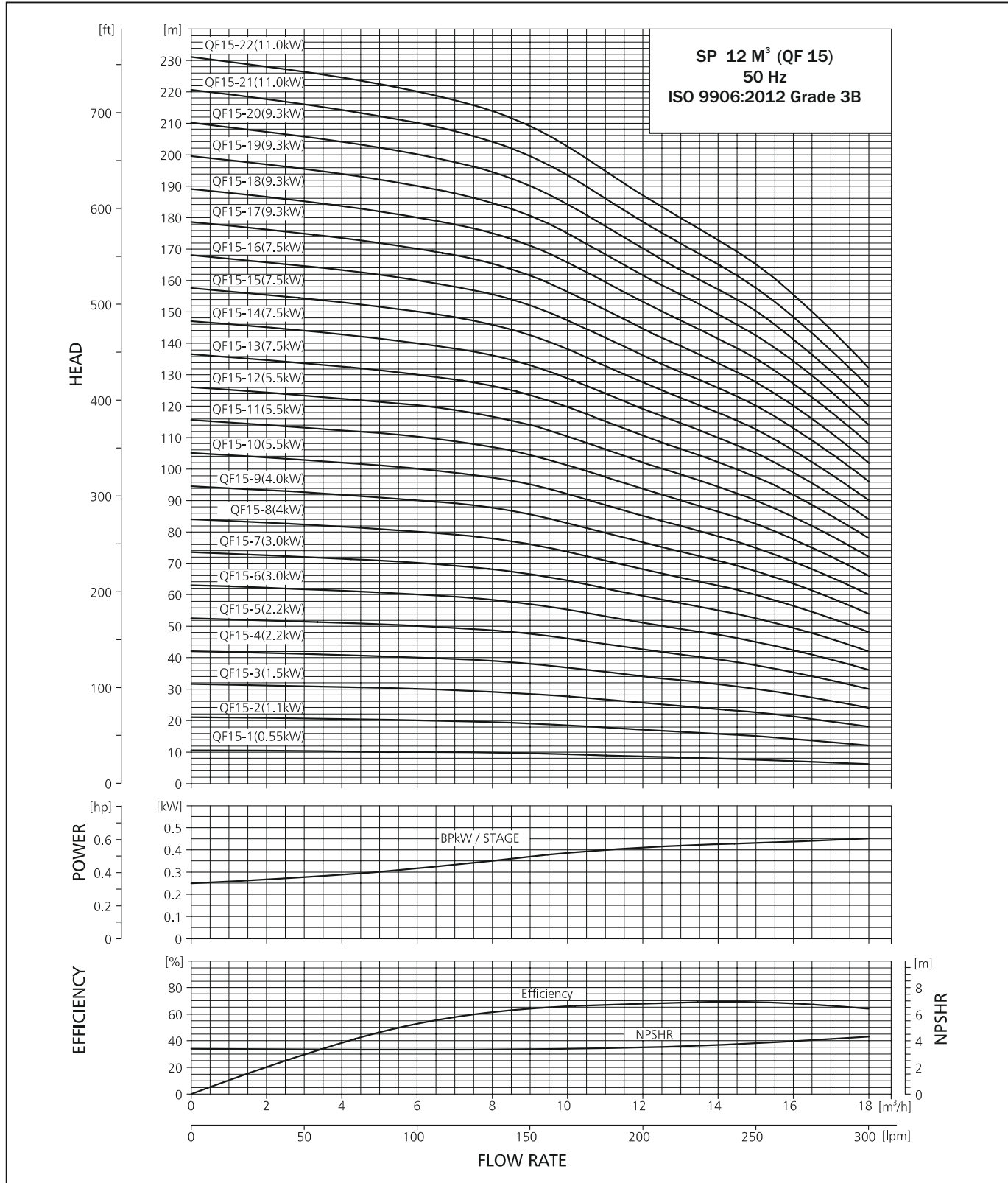

PERFORMANCE CURVE



SUBMERSIBLE PUMP QF 15

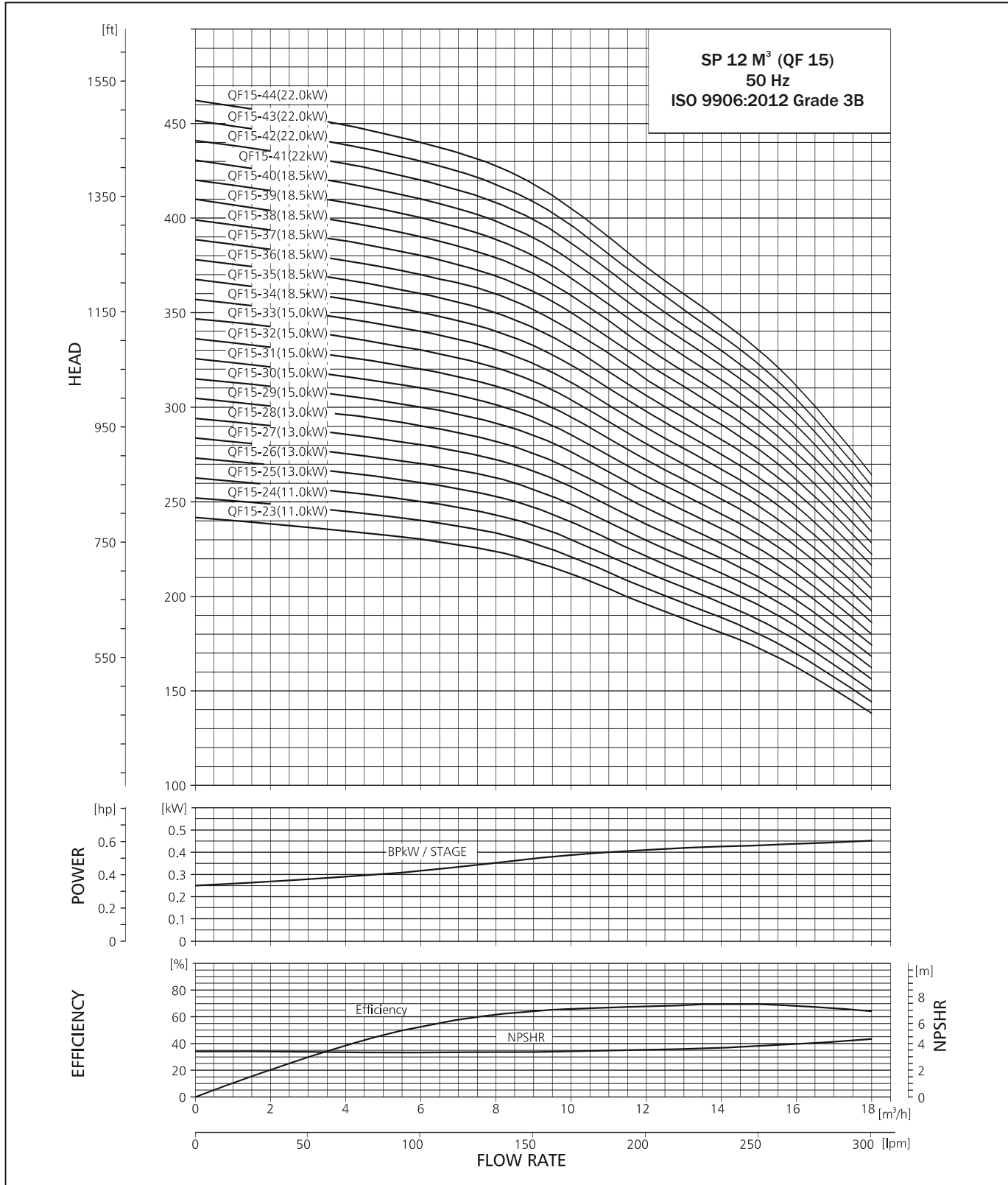

SUBMERSIBLE PUMP QF 15

DIMENSIONS AND WEIGHTS

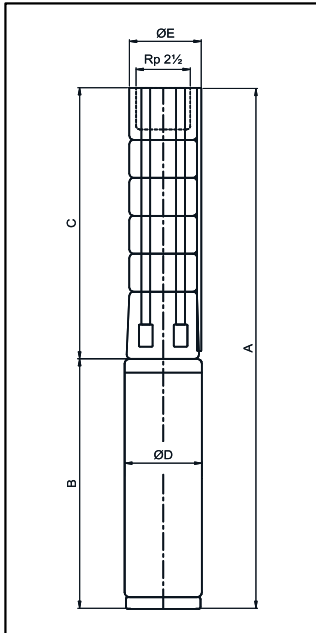

E = Maximum diameter of pump inclusive of cable guard & motor.

TECHNICAL DATA QF 15

PUMP TYPE	MOTOR		DIMENSIONS (MM)							NET WEIGHT (KG)			
	TYPE	POWER (kW)	C	B		A		D	E*	E**	PUMP	MOTOR	
				1x230V	3x220V 3x400V	1x230V	3x220V 3x400V					1x230V	3x220V 3x400V
QF 15-1	PREMIUM 100	0.55	321	291	271	612	592	95	128	-	6.7	11	11
QF 15-2	PREMIUM 100	1.1	382	339	339	721	721	95	128	-	8.0	15	15
QF 15-3	PREMIUM 100	1.5	442	404	404	846	846	95	128	-	9.3	17	17
QF 15-4	PREMIUM 100	2.2	503	538	538	1041	1041	95	128	-	10.6	24	24
QF 15-5	PREMIUM 100	2.2	563	538	538	1101	1101	95	128	-	11.9	24	24
QF 15-6	PREMIUM 100	3	624	690	578	1314	1202	95	128	-	13.2	31	26
QF 15-7	PREMIUM 100	3	684	690	578	1374	1262	95	128	-	14.5	31	26
QF 15-8	PREMIUM 100	4	745	690	690	1435	1435	95	128	-	15.8	31	31
QF 15-9	PREMIUM 100	4	805	690	690	1495	1495	95	128	-	17.1	31	31
QF 15-10	PREMIUM 100	5.5	866	-	767	-	1633	95	128	-	18.4	-	35
QF 15-11	PREMIUM 100	5.5	926	-	767	-	1693	95	128	-	19.7	-	35
QF 15-12	PREMIUM 100	5.5	987	-	767	-	1754	95	128	-	21.0	-	35
QF 15-13	PREMIUM 100	7.5	1047	-	825	-	1872	95	128	-	22.3	-	38
QF 15-14	PREMIUM 100	7.5	1108	-	825	-	1933	95	128	-	23.6	-	38
QF 15-15	PREMIUM 100	7.5	1168	-	825	-	1993	95	128	-	24.9	-	38
QF 15-16	PREMIUM 100	7.5	1229	-	825	-	2054	95	128	-	26.2	-	38
QF 15-11	MATASF 150	5.5	942	-	699	-	1641	145	145	-	21.0	-	51
QF 15-12	MATASF 150	5.5	1002	-	699	-	1701	145	145	-	22.3	-	51
QF 15-13	MATASF 150	7.5	1063	-	719	-	1782	145	145	145	23.6	-	54
QF 15-14	MATASF 150	7.5	1123	-	719	-	1842	145	145	145	24.9	-	54
QF 15-15	MATASF 150	7.5	1184	-	719	-	1903	145	145	145	26.2	-	54
QF 15-16	MATASF 150	7.5	1244	-	719	-	1963	145	145	145	27.5	-	54
QF 15-17	MATASF 150	9.3	1305	-	749	-	2054	145	145	145	28.8	-	57
QF 15-18	MATASF 150	9.3	1365	-	749	-	2114	145	145	145	30.1	-	57
QF 15-19	MATASF 150	9.3	1426	-	749	-	2175	145	145	145	31.4	-	57
QF 15-20	MATASF 150	9.3	1486	-	749	-	2235	145	145	145	32.7	-	57
QF 15-21	MATASF 150	11	1547	-	779	-	2326	145	145	145	34.0	-	59
QF 15-22	MATASF 150	11	1607	-	779	-	2386	145	145	145	35.3	-	59
QF 15-23	MATASF 150	11	1668	-	779	-	2447	145	145	145	36.6	-	59
QF 15-24	MATASF 150	11	1728	-	779	-	2507	145	145	145	37.9	-	59
QF 15-25	MATASF 150	13	1789	-	829	-	2618	145	145	145	39.2	-	64
QF 15-26	MATASF 150	13	1849	-	829	-	2678	145	145	145	40.5	-	64
QF 15-27	MATASF 150	13	1910	-	829	-	2739	145	145	145	41.8	-	64
QF 15-28	MATASF 150	13	1970	-	829	-	2799	145	145	145	43.1	-	64
QF 15-29	MATASF 150	15	2031	-	874	-	2905	145	145	145	44.4	-	70
QF 15-30	MATASF 150	15	2109	-	874	-	2983	145	145	145	45.7	-	70
QF 15-31	MATASF 150	15	2170	-	874	-	3044	145	145	145	47.0	-	70
QF 15-32	MATASF 150	15	2230	-	874	-	3104	145	145	145	48.3	-	70
QF 15-33	MATASF 150	15	2291	-	874	-	3165	145	145	145	49.6	-	70
QF 15-34	MATASF 150	18.5	2351	-	919	-	3270	145	145	145	51.4	-	73
QF 15-35	MATASF 150	18.5	2412	-	919	-	3331	145	145	145	52.7	-	73
QF 15-36	MATASF 150	18.5	2472	-	919	-	3391	145	145	145	54.0	-	73
QF 15-37	MATASF 150	18.5	2533	-	919	-	3452	145	145	145	55.3	-	73
QF 15-38	MATASF 150	18.5	2593	-	919	-	3512	145	145	145	56.6	-	73
QF 15-39	MATASF 150	18.5	2654	-	919	-	3573	145	145	145	57.9	-	73
QF 15-40	MATASF 150	18.5	2714	-	919	-	3633	145	145	145	59.2	-	73
QF 15-41	MATASF 150	22	2775	-	1009	-	3784	145	145	145	60.5	-	82
QF 15-42	MATASF 150	22	2835	-	1009	-	3844	145	145	145	61.9	-	82
QF 15-43	MATASF 150	22	2896	-	1009	-	3905	145	145	145	63.2	-	82
QF 15-44	MATASF 150	22	2956	-	1009	-	3965	145	145	145	64.5	-	82

* Maximum diameter of pump with one motor cable.
 ** Maximum diameter of pump with two motor cable.
 Motor type may change as per requirement.

TECHNICAL DATA



SUBMERSIBLE PUMP QF 15

PERFORMANCE TABLE QF 15

QF-15		MATERIAL CODE		MOTOR RATING		DISCHARGE (Q)										
						m ³ /h		0	2	6	8	10	12	14	16	18
MODEL	CONNE- -CTION	4x6		6x6		l/min.		0	33.3	100	133.3	166.7	200	233.3	266.7	300
		[kW]		[HP]		TOTAL HEAD IN (m)										
QF15-1	Rp2"	9000002816	-	0.55	0.75	12	11	10.5	10	9.5	9	8	7	6		
QF15-2		9000002834	-	1.1	1.5	22	21	20	19	18	17	15	13	12		
QF15-3		9000002845	-	1.5	2	32	31	30	29	27	26	23	20	18		
QF15-4		9000002856	9000018397	2.2	3	42	41	40	38	36	34	30	26	24		
QF15-5		9000002862	9000002863	2.2	3	53	51	50	48	45	43	38	33	30		
QF15-6		9000002864	9000011427	3	4	63	61	60	57	54	51	45	39	36		
QF15-7		9000002865	9000011099	3	4	74	71	70	67	63	60	53	46	42		
QF15-8		9000002866	9000002867	4	5.5	84	82	80	76	72	68	60	52	48		
QF15-9		9000002868	9000002869	4	5.5	95	92	90	86	81	77	68	59	54		
QF15-10		9000002817	9000002818	5.5	7.5	105	102	100	95	90	85	75	66	60		
QF15-11		9000002819	9000002820	5.5	7.5	116	112	110	105	99	94	83	72	66		
QF15-12		9000002821	9000002822	5.5	7.5	126	122	120	114	108	102	90	79	72		
QF15-13		9000002823	9000002824	7.5	10	137	133	130	124	117	111	98	85	78		
QF15-14		9000002825	9000002826	7.5	10	147	143	140	133	126	119	105	92	84		
QF15-15		9000002827	9000002828	7.5	10	158	153	150	143	135	128	113	98	90		
QF15-16		9000002829	9000002830	7.5	10	168	163	160	152	144	136	120	105	96		
QF15-17		-	9000002831	9.3	12.5	179	173	170	162	153	145	128	111	102		
QF15-18		-	9000002832	9.3	12.5	189	184	180	171	162	153	135	118	108		
QF15-19		-	9000002833	9.3	12.5	200	194	190	181	171	162	143	124	114		
QF15-20		-	9000002835	9.3	12.5	210	204	200	190	180	170	150	131	120		
QF15-21		-	9000002836	11	15	221	214	210	200	189	179	158	138	126		
QF15-22		-	9000002837	11	15	231	224	220	209	198	187	165	144	132		
QF15-23		-	9000002838	11	15	242	235	230	219	207	196	173	151	138		
QF15-24		-	9000002839	11	15	252	245	240	228	216	204	180	157	144		
QF15-25		-	9000002840	13	17.5	263	255	250	238	225	213	188	164	150		
QF15-26		-	9000002841	13	17.5	273	265	260	247	234	221	195	170	156		
QF15-27		-	9000002842	13	17.5	284	275	270	257	243	230	203	177	162		
QF15-28		-	9000002843	13	17.5	294	286	280	266	252	238	210	183	168		
QF15-29		-	9000002844	15	20	305	296	290	276	261	247	218	190	174		
QF15-30		-	9000002846	15	20	315	306	300	285	270	255	225	197	180		
QF15-31		-	9000002847	15	20	326	316	310	295	279	264	233	203	186		
QF15-32		-	9000002848	15	20	336	326	320	304	288	272	240	210	192		
QF15-33		-	9000002849	15	20	347	337	330	314	297	281	248	216	198		
QF15-34		-	9000002850	18.5	25	357	347	340	323	306	289	255	223	204		
QF15-35		-	9000002851	18.5	25	368	357	350	333	315	298	263	229	210		
QF15-36		-	9000002852	18.5	25	378	367	360	342	324	306	270	236	216		
QF15-37		-	9000002853	18.5	25	389	377	370	352	333	315	278	242	222		
QF15-38		-	9000002854	18.5	25	399	388	380	361	342	323	285	249	228		
QF15-39		-	9000002855	18.5	25	410	398	390	371	351	332	293	255	234		
QF15-40		-	9000002857	18.5	25	420	408	400	380	360	340	300	262	240		
QF15-41		-	9000002858	22	30	431	418	410	390	369	349	308	269	246		
QF15-42		-	9000002859	22	30	441	428	420	399	378	357	315	275	252		
QF15-43		-	9000002860	22	30	452	439	430	409	387	366	323	282	258		
QF15-44		-	9000002861	22	30	462	449	440	418	396	374	330	288	264		

PERFORMANCE CURVE



SUBMERSIBLE PUMP QF 30

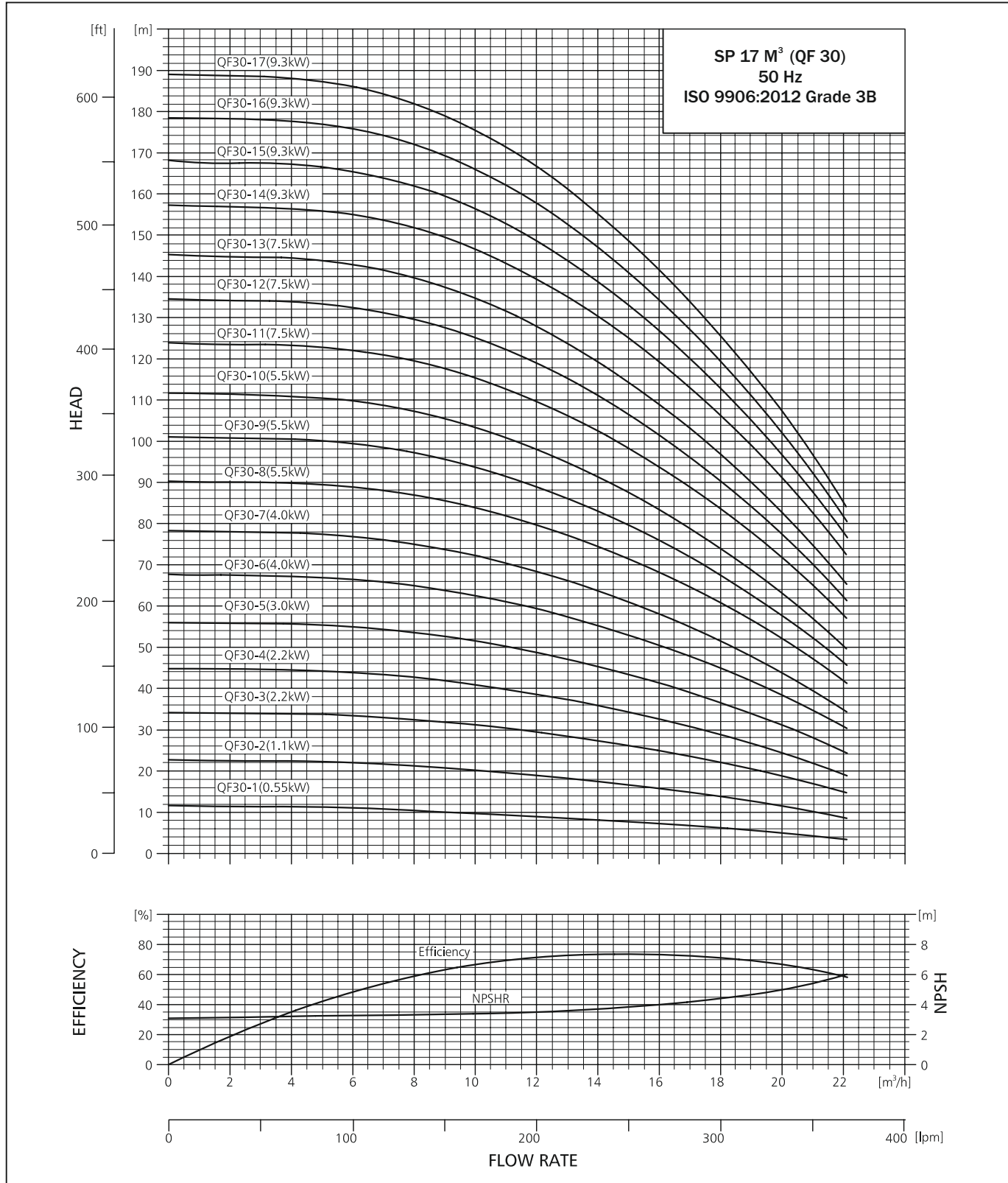

PERFORMANCE CURVE



SUBMERSIBLE PUMP QF 30

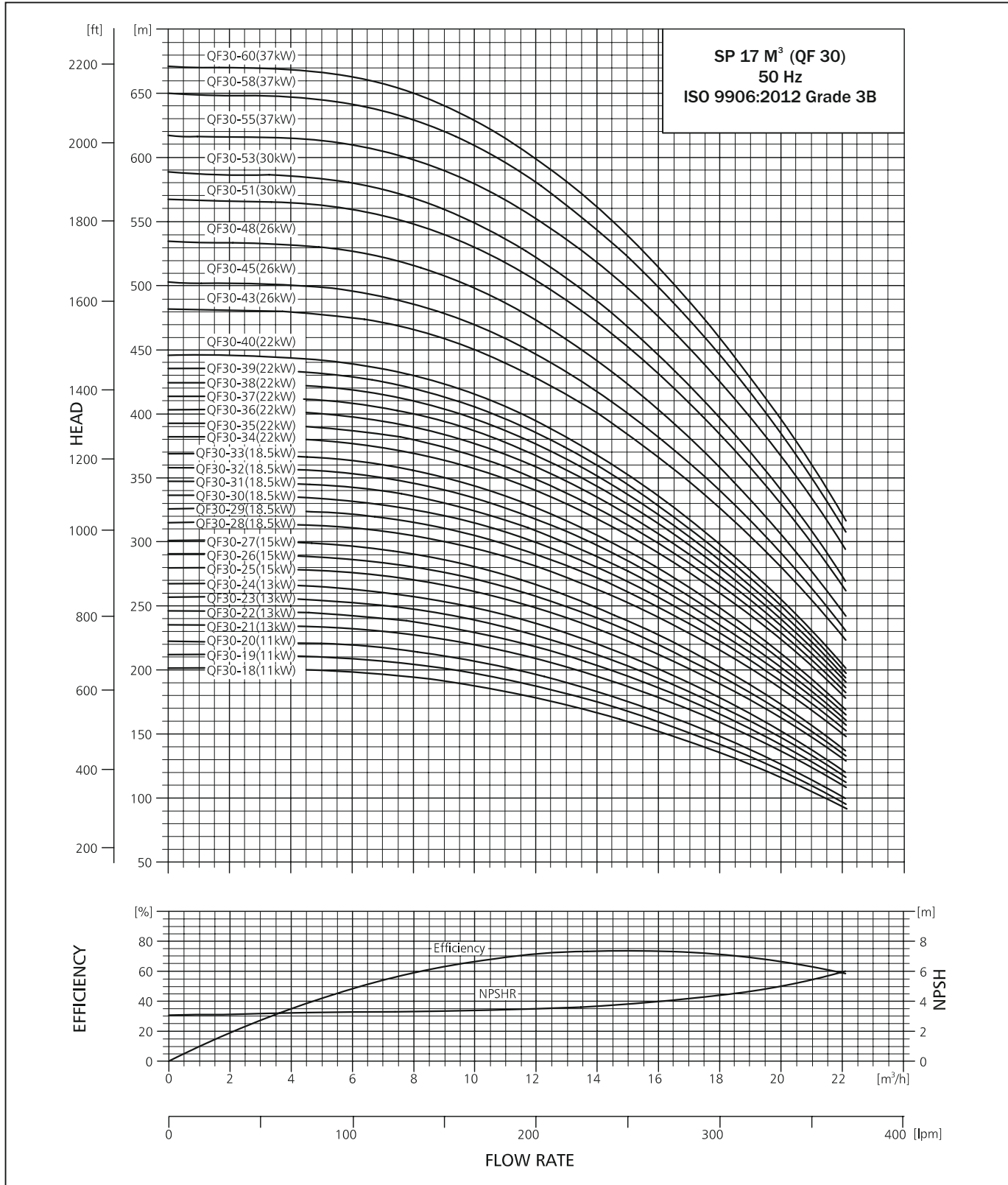

TECHNICAL DATA



SUBMERSIBLE PUMP QF 30

DIMENSIONS AND WEIGHTS

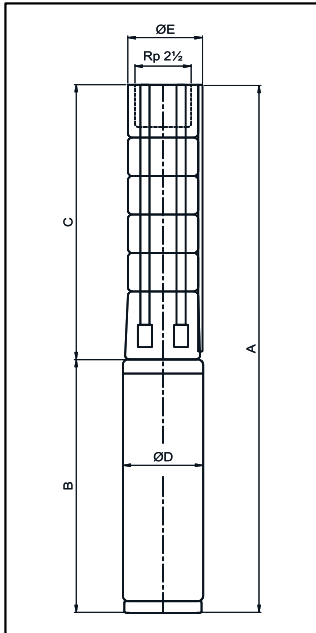

E = Maximum diameter of pump inclusive of cable guard & motor.

TECHNICAL DATA QF 30

PUMP TYPE	MOTOR		DIMENSIONS (mm)								NET WEIGHT (kg)		
	TYPE	POWER (kW)	C	B		A		D	E*	E**	PUMP	MOTOR	
				1x230V	3x220V 3x400V	1x230V	3x220V 3x400V					1x230V	3x220V 3x400V
QF30 1	PREMIUM 100	0.55	321	291	271	612	592	95	128	-	6.7	11	11
QF30 2	PREMIUM 100	1.1	382	339	339	721	721	95	128	-	8.0	15	15
QF30 3	PREMIUM 100	2.2	442	538	538	980	980	95	128	-	9.3	24	24
QF30 4	PREMIUM 100	2.2	503	538	538	1041	1041	95	128	-	10.6	24	24
QF30 5	PREMIUM 100	3.0	563	690	578	1253	1141	95	128	-	11.9	31	26
QF30 6	PREMIUM 100	4.0	624	690	690	1314	1314	95	128	-	13.2	31	31
QF30 7	PREMIUM 100	4.0	684	690	690	1374	1374	95	128	-	14.5	31	31
QF30 8	PREMIUM 100	5.5	745	-	767	-	1512	95	128	-	15.8	-	35
QF30 9	PREMIUM 100	5.5	805	-	767	-	1572	95	128	-	17.1	-	35
QF30 10	PREMIUM 100	5.5	866	-	767	-	1633	95	128	-	18.9	-	35
QF30 11	PREMIUM 100	7.5	926	-	825	-	1751	95	128	-	19.7	-	38
QF30 12	PREMIUM 100	7.5	987	-	825	-	1812	95	128	-	21.0	-	38
QF30 13	PREMIUM 100	7.5	1047	-	825	-	1872	95	128	-	22.3	-	38
QF30 8	MATASF 150	5.5	760	-	699	-	1459	145	145	145	17.1	-	51
QF30 9	MATASF 150	5.5	821	-	699	-	1520	145	145	145	18.9	-	51
QF30 10	MATASF 150	5.5	881	-	699	-	1580	145	145	145	19.7	-	51
QF30 11	MATASF 150	7.5	942	-	719	-	1661	145	145	145	21.0	-	54
QF30 12	MATASF 150	7.5	1002	-	719	-	1721	145	145	145	22.3	-	54
QF30 13	MATASF 150	7.5	1063	-	719	-	1782	145	145	145	23.6	-	54
QF30 14	MATASF 150	9.3	1123	-	749	-	1872	145	145	145	24.9	-	57
QF30 15	MATASF 150	9.3	1184	-	749	-	1933	145	145	145	26.2	-	57
QF30 16	MATASF 150	9.3	1244	-	749	-	1993	145	145	145	27.5	-	57
QF30 17	MATASF 150	9.3	1305	-	749	-	2054	145	145	145	28.8	-	57
QF30 18	MATASF 150	11	1365	-	779	-	2144	145	145	145	30.1	-	59
QF30 19	MATASF 150	11	1426	-	779	-	2205	145	145	145	31.4	-	59
QF30 20	MATASF 150	11	1486	-	779	-	2265	145	145	145	32.7	-	59
QF30 21	MATASF 150	13	1547	-	829	-	2376	145	145	145	34	-	64
QF30 22	MATASF 150	13	1607	-	829	-	2436	145	145	145	35.3	-	64
QF30 23	MATASF 150	13	1668	-	829	-	2497	145	145	145	36.6	-	64
QF30 24	MATASF 150	13	1728	-	829	-	2557	145	145	145	37.9	-	64
QF30 25	MATASF 150	15	1789	-	874	-	2663	145	145	145	39.2	-	70
QF30 26	MATASF 150	15	1849	-	874	-	2723	145	145	145	40.5	-	70
QF30 27	MATASF 150	15	1910	-	874	-	2784	145	145	145	41.8	-	70
QF30 28	MATASF 150	18.5	1970	-	919	-	2889	145	145	145	43.1	-	73
QF30 29	MATASF 150	18.5	2031	-	919	-	2950	145	145	145	44.4	-	73
QF30 30	MATASF 150	18.5	2109	-	919	-	3028	145	145	145	45.7	-	73
QF30 31	MATASF 150	18.5	2170	-	919	-	3089	145	145	145	47	-	73
QF30 32	MATASF 150	18.5	2230	-	919	-	3149	145	145	145	48.3	-	73
QF30 33	MATASF 150	18.5	2291	-	919	-	3210	145	145	145	49.6	-	73
QF30 34	MATASF 150	22	2351	-	1009	-	3360	145	145	145	51.4	-	82
QF30 35	MATASF 150	22	2412	-	1009	-	3421	145	145	145	52.7	-	82
QF30 36	MATASF 150	22	2472	-	1009	-	3481	145	145	145	54	-	82
QF30 37	MATASF 150	22	2533	-	1009	-	3542	145	145	145	55.3	-	82
QF30 38	MATASF 150	22	2593	-	1009	-	3602	145	145	145	56.6	-	82
QF30 39	MATASF 150	22	2654	-	1009	-	3663	145	145	145	57.9	-	82
QF30 40	MATASF 150	22	2714	-	1009	-	3723	145	145	145	59.2	-	81
QF30 43	MATASF 150	26	2896	-	1114	-	4010	145	145	145	63.2	-	98
QF30 45	MATASF 150	26	3017	-	1114	-	4131	145	145	145	65.8	-	98
QF30 48	MATASF 150	26	3198	-	1114	-	4312	145	145	145	69.7	-	98
QF30 51	MATASF 150	30	3380	-	1214	-	4594	145	145	145	73.6	-	107
QF30 53	MATASF 150	30	3501	-	1214	-	4715	145	145	145	76.2	-	107
QF30 55	MATASF 150	37	3622	-	1294	-	4916	145	145	145	78.3	-	115
QF30 51	MATASF 200	30	3408	-	1140	-	4548	194	194	194	77.0	-	164
QF30 53	MATASF 200	30	3529	-	1140	-	4669	194	194	194	73.6	-	164
QF30 55	MATASF 200	37	3650	-	1140	-	4790	194	194	194	82.2	-	164
QF30 58	MATASF 200	37	3832	-	1140	-	4972	194	194	194	86.1	-	164
QF30 60	MATASF 200	37	3953	-	1140	-	5093	194	194	194	88.7	-	164

* Maximum diameter of pump with one motor cable.

** Maximum diameter of pump with two motor cable.

Motor type may change as per requirement.

TECHNICAL DATA



SUBMERSIBLE PUMP QF 30

PERFORMANCE TABLE QF 30

QF-30				m ³ /h		DISCHARGE (Q)											
						0	2	4	6	8	10	12	14	16	18	20	22
				l/min.		0	33.3	66.7	100	133.3	166.7	200	233.3	266.7	300	333.3	366.7
MODEL	MATERIAL CODE			MOTOR RATING		TOTAL HEAD IN (m)											
	4x6	6x6	8x6 (W.SLEAVE)	[kW]	[HP]												
QF 30 - 1	9000002870	-	-	0.55	0.75	12	11	11	11	10	10	9	8	7	6	5	4
QF 30 - 2	9000002871	-	-	1.1	1.5	23	23	22	22	21	20	19	17	16	14	12	9
QF 30 - 3	9000002872	9000011087	-	2.2	3	34	34	34	33	33	31	29	27	25	22	19	15
QF 30 - 4	9000002873	9000010928	-	2.2	3	45	45	44	44	43	41	39	36	33	29	24	19
QF 30 - 5	9000002874	9000002875	-	3	4	56	56	56	55	54	51	49	45	41	37	31	25
QF 30 - 6	9000002876	9000002877	-	4	5.5	68	67	67	66	65	63	59	55	50	45	38	31
QF 30 - 7	9000002879	9000002880	-	4	5.5	78	78	78	77	75	72	68	64	58	52	44	35
QF 30 - 8	9000002881	9000002882	-	5.5	7.5	90	90	90	89	87	84	80	74	68	61	52	42
QF 30 - 9	9000002883	9000002884	-	5.5	7.5	101	101	100	99	97	94	89	83	76	67	58	46
QF 30 - 10	9000002887	9000002888	-	5.5	7.5	112	111	111	110	107	103	98	91	83	74	63	50
QF 30 - 11	9000002890	9000002891	-	7.5	10	124	124	123	122	119	115	110	102	94	84	72	58
QF 30 - 12	9000002893	9000002894	-	7.5	10	135	134	134	132	130	125	119	111	101	90	77	62
QF 30 - 13	9000002896	9000002897	-	7.5	10	145	145	144	143	140	135	128	119	109	97	83	66
QF 30 - 14	-	9000002899	-	9.3	12.5	157	157	156	155	152	147	139	130	119	106	91	74
QF 30 - 15	-	9000002901	-	9.3	12.5	168	168	167	165	162	156	149	139	127	113	97	78
QF 30 - 16	-	9000002903	-	9.3	12.5	179	178	178	176	172	166	158	147	134	119	102	82
QF 30 - 17	-	9000002905	-	9.3	12.5	189	189	188	186	182	175	166	155	141	126	107	86
QF 30 - 18	-	9000002907	-	11	15	202	201	200	199	194	188	178	167	152	136	116	94
QF 30 - 19	-	9000002909	-	11	15	212	212	211	209	204	197	187	175	160	142	121	97
QF 30 - 20	-	9000002912	-	11	15	223	222	221	219	214	207	196	183	167	148	126	101
QF 30 - 21	-	9000002914	-	13	17.5	235	235	234	232	227	220	209	195	179	159	137	110
QF 30 - 22	-	9000002916	-	13	17.5	246	246	245	243	237	229	218	204	186	166	142	114
QF 30 - 23	-	9000002918	-	13	17.5	257	256	255	253	248	239	227	212	193	172	147	118
QF 30 - 24	-	9000002920	-	13	17.5	267	267	266	263	258	248	236	220	201	178	152	122
QF 30 - 25	-	9000002922	-	15	20	280	279	279	276	270	261	248	232	212	189	162	131
QF 30 - 26	-	9000002924	-	15	20	291	290	289	286	280	271	257	240	220	196	168	135
QF 30 - 27	-	9000002926	-	15	20	301	300	300	297	290	280	266	249	227	202	173	139
QF 30 - 28	-	9000002928	-	18.5	25	315	314	314	311	305	295	281	263	241	215	186	151
QF 30 - 29	-	9000002930	-	18.5	25	326	325	324	321	315	305	290	272	249	222	191	155
QF 30 - 30	-	9000002933	-	18.5	25	336	336	335	332	325	315	299	280	257	229	197	159
QF 30 - 31	-	9000002934	-	18.5	25	347	346	346	342	336	324	309	289	264	236	202	163
QF 30 - 32	-	9000002935	-	18.5	25	358	357	356	353	346	334	318	297	272	242	208	168
QF 30 - 33	-	9000002937	-	18.5	25	368	368	367	363	356	344	327	305	279	249	213	172
QF 30 - 34	-	9000002938	-	22	30	382	381	380	377	369	357	340	318	291	260	223	181
QF 30 - 35	-	9000002939	-	22	30	392	392	391	387	380	367	349	326	299	266	229	185
QF 30 - 36	-	9000002941	-	22	30	403	402	401	398	390	377	358	335	306	273	234	189
QF 30 - 37	-	9000002942	-	22	30	414	413	412	408	400	386	367	343	314	279	240	193
QF 30 - 38	-	9000002943	-	22	30	425	424	423	418	410	396	376	351	321	286	245	197
QF 30 - 39	-	9000002945	-	22	30	435	434	433	429	420	405	385	360	328	292	250	201
QF 30 - 40	-	9000002948	-	22	30	446	445	444	439	430	415	394	368	336	298	255	205
QF 30 - 43	-	9000008072	-	26	35	481	481	479	475	466	450	428	400	366	326	280	227
QF 30 - 45	-	9000010950	-	26	35	503	502	501	496	486	469	446	417	381	339	291	235
QF 30 - 48	-	9000011244	-	26	35	535	534	532	527	516	498	473	441	403	358	306	246
QF 30 - 51	-	-	9000002955	30	40	568	567	561	559	548	529	502	468	428	380	325	261
QF 30 - 53	-	-	9000002957	30	40	590	589	583	581	569	550	522	486	445	395	338	271
QF 30 - 55	-	-	9000002959	37	50	613	612	610	604	591	571	541.98	505	462	410	351	282
QF 30 - 58	-	-	9000002961	37	50	646	645	643	637	623	602	571	533	487	433	370	297
QF 30 - 60	-	-	9000002964	37	50	669	667	665	659	645	622	591	551	504	447	382	307

PERFORMANCE CURVE



SUBMERSIBLE PUMP QF 30

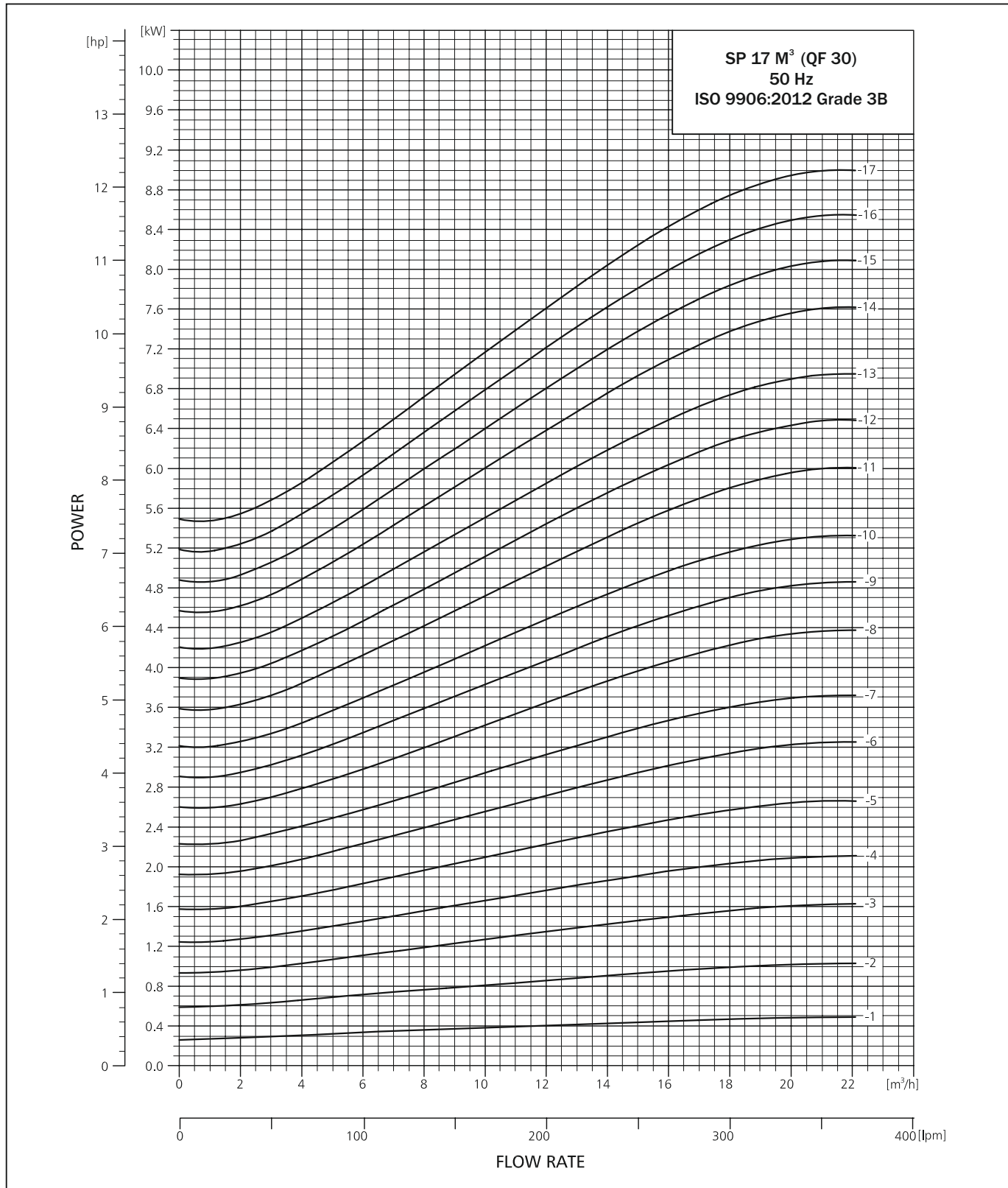

PERFORMANCE CURVE

SUBMERSIBLE PUMP QF 30

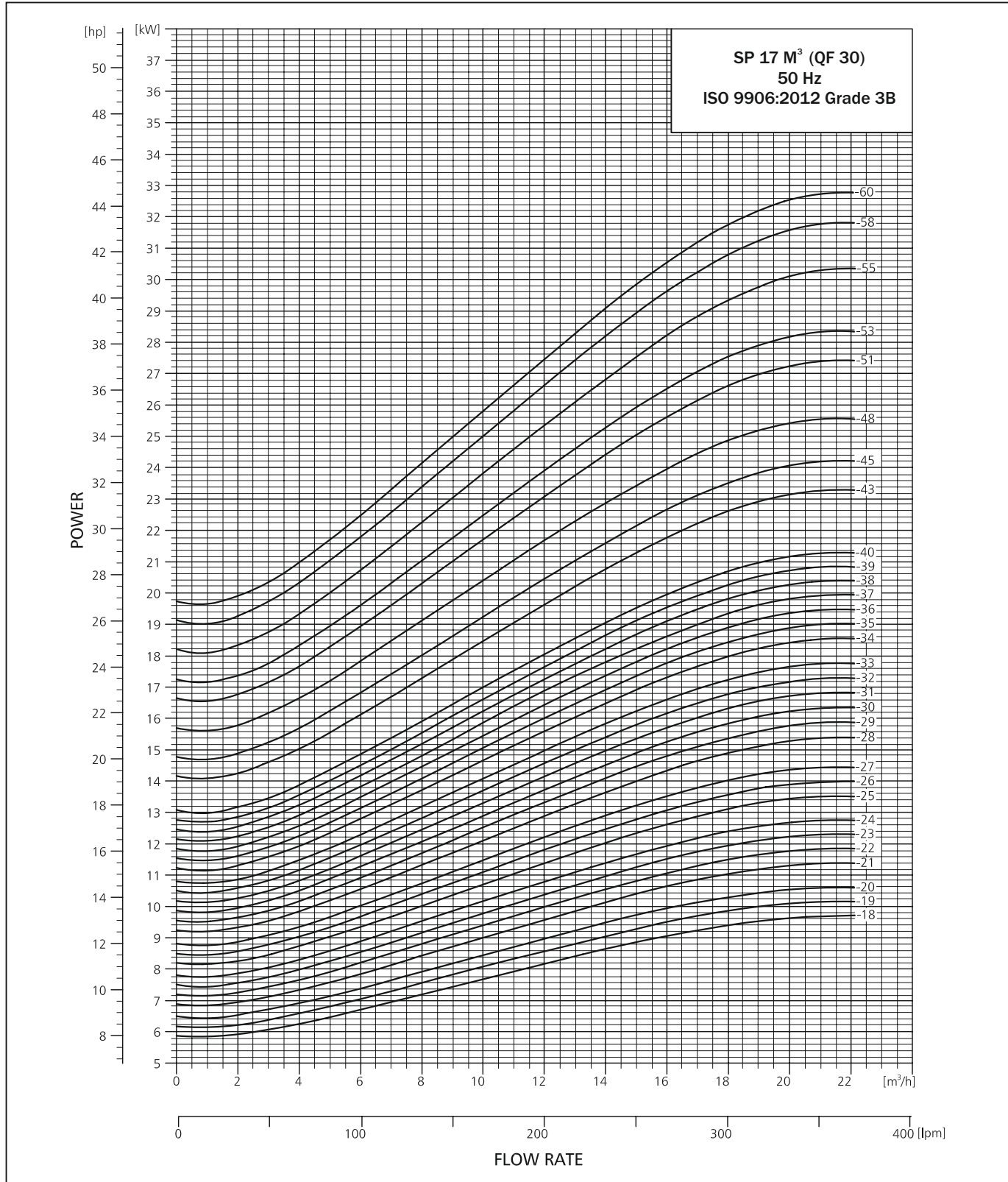

PERFORMANCE CURVE

SUBMERSIBLE PUMP QF 50

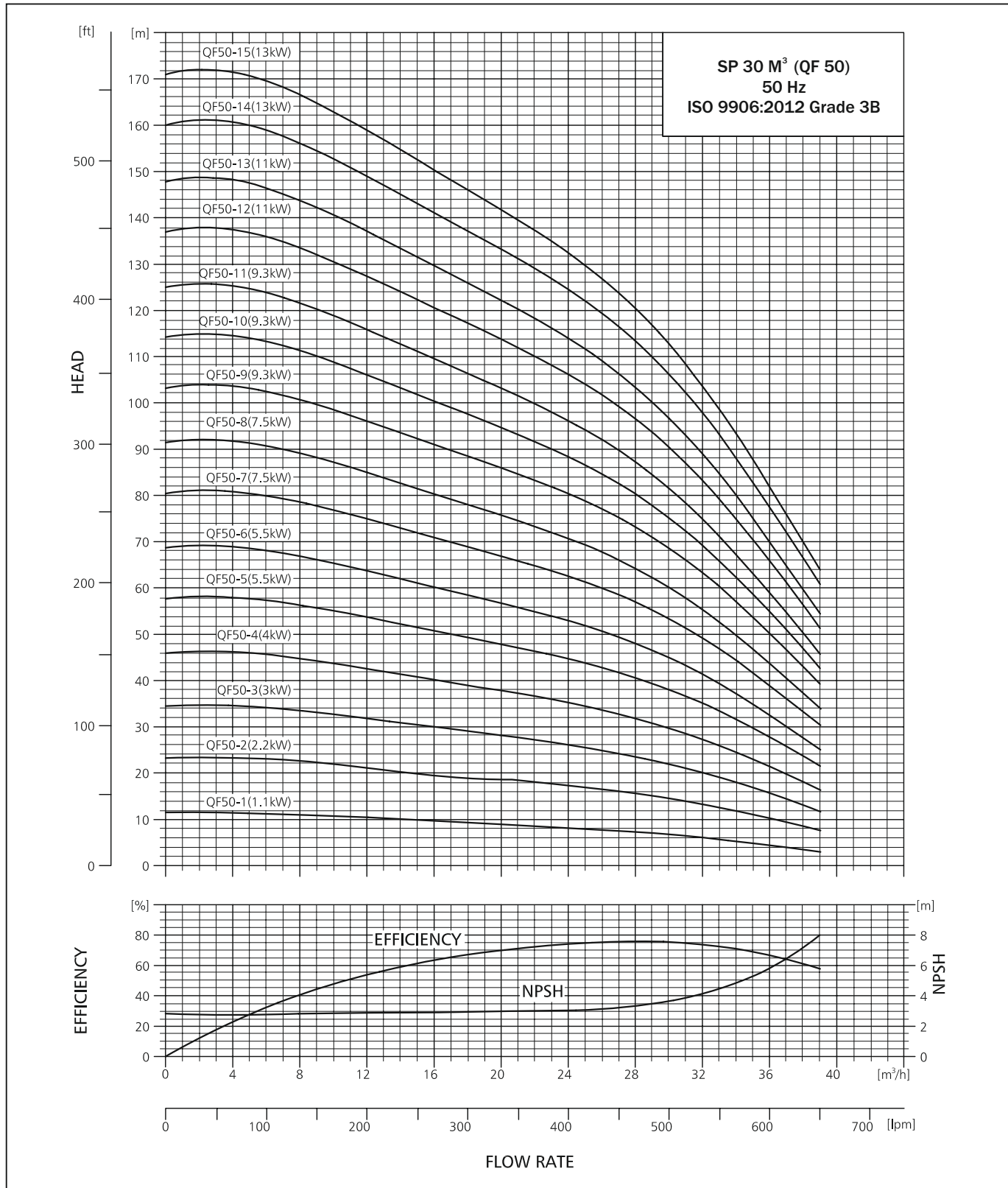

PERFORMANCE CURVE



SUBMERSIBLE PUMP QF 50

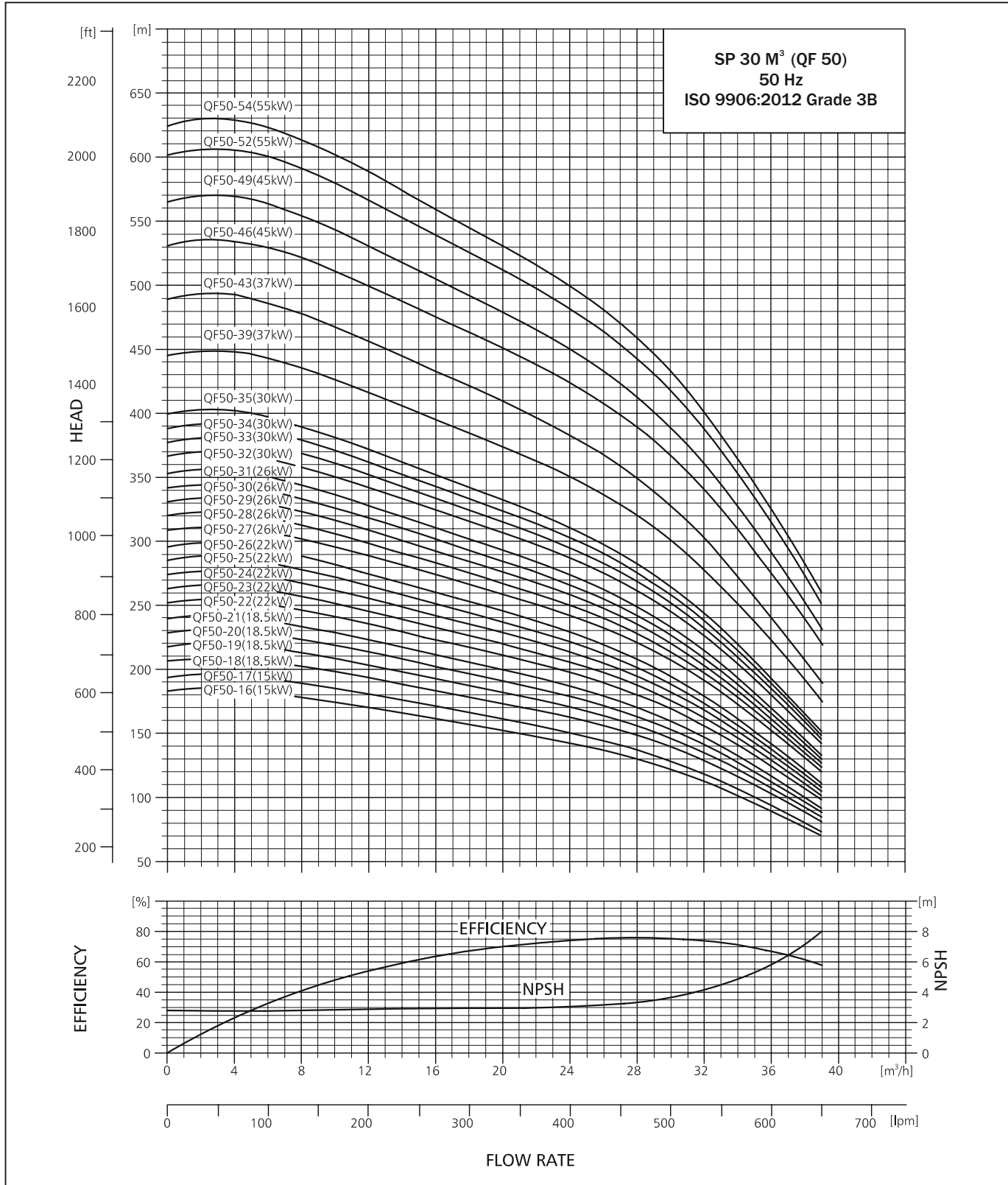

TECHNICAL DATA



SUBMERSIBLE PUMP QF 50

DIMENSIONS AND WEIGHTS

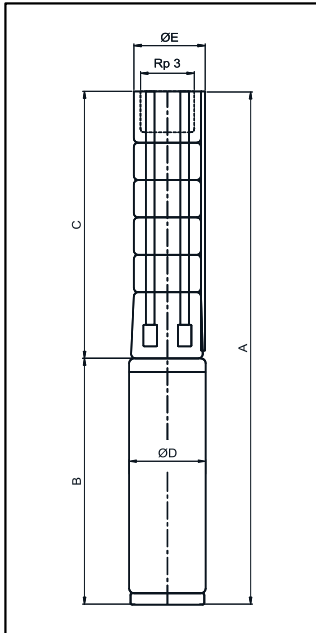

E = Maximum diameter of pump inclusive of cable guard & motor.

TECHNICAL DATA QF 50

PUMP TYPE	MOTOR		C	DIMENSIONS (mm)						NET WEIGHT (kg)			
	TYPE	POWER (kW)		B		A		D	E*	E**	PUMP	MOTOR	
				1x230V	3x220V 3x400V	1x230V	3x220V 3x400V					1x230V	3x220V 3x400V
QF50- 1	PREMIUM 100	1.1	362	339	339	701	701	95	128	-	7.9	15	15
QF50- 2	PREMIUM 100	2.2	458	538	538	996	996	95	128	-	9.8	24	24
QF50- 3	PREMIUM 100	3.0	554	690	578	1244	1132	95	128	-	11.7	31	26
QF50- 4	PREMIUM 100	4.0	650	690	690	1340	1340	95	128	-	13.6	31	31
QF50- 5	PREMIUM 100	5.5	746	-	767	-	1513	95	128	-	15.5	-	35
QF50- 6	PREMIUM 100	5.5	842	-	767	-	1609	95	128	-	17.4	-	35
QF50- 7	PREMIUM 100	7.5	938	-	825	-	1763	95	128	-	19.3	-	38
QF50- 8	PREMIUM 100	7.5	1034	-	825	-	1859	95	128	-	21.2	-	38
QF50- 5	MATASF 150	5.5	761	-	699	-	1460	145	145	145	16.5	-	51
QF50- 6	MATASF 150	5.5	857	-	699	-	1556	145	145	145	18.4	-	51
QF50- 7	MATASF 150	7.5	953	-	719	-	1672	145	145	145	20.3	-	54
QF50- 8	MATASF 150	7.5	1049	-	719	-	1768	145	145	145	22.2	-	54
QF50- 9	MATASF 150	9.3	1145	-	749	-	1894	145	145	145	24.1	-	57
QF50- 10	MATASF 150	9.3	1241	-	749	-	1990	145	145	145	26.0	-	57
QF50- 11	MATASF 150	9.3	1337	-	749	-	2086	145	145	145	27.9	-	57
QF50- 12	MATASF 150	11	1433	-	779	-	2212	145	145	145	29.8	-	59
QF50- 13	MATASF 150	11	1529	-	779	-	2308	145	145	145	31.7	-	59
QF50- 14	MATASF 150	13	1625	-	829	-	2454	145	145	145	33.6	-	64
QF50- 15	MATASF 150	13	1721	-	829	-	2550	145	145	145	35.5	-	64
QF50- 16	MATASF 150	15	1817	-	874	-	2691	145	145	145	37.4	-	70
QF50- 17	MATASF 150	15	1913	-	874	-	2787	145	145	145	39.3	-	70
QF50- 18	MATASF 150	18.5	2009	-	919	-	2928	145	145	145	41.2	-	73
QF50- 19	MATASF 150	18.5	2105	-	919	-	3024	145	145	145	43.1	-	73
QF50- 20	MATASF 150	18.5	2201	-	919	-	3120	145	145	145	45.0	-	73
QF50- 21	MATASF 150	18.5	2297	-	919	-	3216	145	145	145	46.9	-	73
QF50- 22	MATASF 150	22	2393	-	1009	-	3402	145	145	145	48.8	-	82
QF50- 23	MATASF 150	22	2489	-	1009	-	3498	145	145	145	52.4	-	82
QF50- 24	MATASF 150	22	2585	-	1009	-	3594	145	145	145	54.4	-	82
QF50- 25	MATASF 150	22	2681	-	1009	-	3690	145	145	145	56.4	-	82
QF50- 26	MATASF 150	22	2777	-	1009	-	3786	145	145	145	58.4	-	82
QF50- 27	MATASF 150	26	2873	-	1114	-	3987	145	145	145	60.4	-	98
QF50- 28	MATASF 150	26	2969	-	1114	-	4083	145	145	145	62.4	-	98
QF50- 29	MATASF 150	26	3065	-	1114	-	4179	145	145	145	64.4	-	98
QF50- 30	MATASF 150	26	3161	-	1114	-	4275	145	145	145	66.4	-	98
QF50- 31	MATASF 150	26	3257	-	1114	-	4371	145	145	145	68.4	-	98
QF50- 32	MATASF 150	30	3353	-	1214	-	4567	145	145	145	70.4	-	107
QF50- 33	MATASF 150	30	3449	-	1214	-	4663	145	145	145	72.4	-	107
QF50- 34	MATASF 150	30	3545	-	1214	-	4759	145	145	145	74.4	-	107
QF50- 35	MATASF 150	30	3641	-	1214	-	4855	145	145	145	76.4	-	107
QF50- 32	MATASF 200	30	3382	-	1140	-	4522	194	194	194	73.8	-	164
QF50- 33	MATASF 200	30	3478	-	1140	-	4618	194	194	194	75.8	-	164
QF50- 34	MATASF 200	30	3574	-	1140	-	4714	194	194	194	77.8	-	164
QF50- 35	MATASF 200	30	3670	-	1140	-	4810	194	194	194	79.8	-	164
QF50- 39	MATASF 200	37	4054	-	1140	-	5194	194	194	194	87.8	-	164
QF50- 43	MATASF 200	37	4438	-	1140	-	5578	194	194	194	95.8	-	164
QF50- 46	MATASF 200	45	4726	-	1230	-	5956	194	194	194	101.8	-	189
QF50- 49	MATASF 200	45	5014	-	1230	-	6244	194	194	194	107.8	-	189
QF50- 52	MATASF 200	55	5302	-	1340	-	6642	194	194	194	113.8	-	203
QF50- 54	MATASF 200	55	5494	-	1340	-	6834	194	194	194	117.8	-	203

* Maximum diameter of pump with one motor cable.
 ** Maximum diameter of pump with two motor cable.
 Motor type may change as per requirement.

SUBMERSIBLE PUMP QF 50

PERFORMANCE TABLE QF 50

QF-50				DISCHARGE (Q)											
				m ³ /h		0	4	8	12	16	20	24	28	32	39
				l/min.		0	66.7	133.3	200	266.7	333.3	400	466.7	533.3	650
MODEL	MATERIAL CODE			MOTOR RATING		TOTAL HEAD IN (m)									
	4x6	6x6	8x6	[kW]	[HP]										
QF 50 - 1	9000002971	-	-	1.1	1.5	11	11	11	10	10	9	8	7	6	3
QF 50 - 2	9000002972	9000002973	-	2.2	3	23	23	23	21	20	19	17	16	13	8
QF 50 - 3	9000002974	9000002975	-	3	4	35	35	33	32	30	28	26	24	20	12
QF 50 - 4	9000002976	9000002977	-	4	5.5	46	46	45	43	40	38	35	32	27	16
QF 50 - 5	9000002978	9000002979	-	5.5	7.5	58	58	56	54	51	48	45	41	35	22
QF 50 - 6	9000002980	9000002981	-	5.5	7.5	69	69	67	64	60	57	53	48	41	25
QF 50 - 7	9000002982	9000002983	-	7.5	10	80	81	79	75	71	67	63	57	49	31
QF 50 - 8	9000002984	9000002985	-	7.5	10	91	92	89	85	80	76	71	64	55	34
QF 50 - 9	-	9000002986	-	9.3	12.5	103	104	101	96	91	86	80	73	63	39
QF 50 - 10	-	9000002989	-	9.3	12.5	114	115	111	106	100	95	88	80	69	43
QF 50 - 11	-	9000002991	-	9.3	12.5	125	125	122	116	110	103	96	87	75	46
QF 50 - 12	-	9000002993	-	11	15	137	137	134	127	121	114	106	97	83	51
QF 50 - 13	-	9000002995	-	11	15	148	148	144	137	130	122	114	103	89	55
QF 50 - 14	-	9000002997	-	13	17.5	160	161	156	149	141	133	125	113	98	61
QF 50 - 15	-	9000002999	-	13	17.5	171	171	167	159	150	142	132	120	104	64
QF 50 - 16	-	9000003001	-	15	20	183	184	179	171	162	153	143	130	112	70
QF 50 - 17	-	9000003003	-	15	20	194	195	189	180	171	161	151	137	118	74
QF 50 - 18	-	9000003005	-	18.5	25	207	208	202	193	183	173	163	148	129	82
QF 50 - 19	-	9000003007	-	18.5	25	218	219	213	203	193	182	171	156	135	85
QF 50 - 20	-	9000003011	-	18.5	25	229	230	223	213	202	191	179	163	141	89
QF 50 - 21	-	9000003013	-	18.5	25	240	241	234	223	212	200	187	170	147	92
QF 50 - 22	-	9000003015	-	22	30	252	253	246	235	223	211	198	180	156	99
QF 50 - 23	-	9000003017	-	22	30	263	264	257	245	233	220	206	188	162	102
QF 50 - 24	-	9000003018	-	22	30	274	275	268	255	242	228	214	195	168	105
QF 50 - 25	-	9000003022	-	22	30	285	286	278	265	251	237	221	201	174	108
QF 50 - 26	-	9000003025	-	22	30	296	297	288	275	260	245	229	208	179	111
QF 50 - 27	-	9000003029	-	26	35	309	310	302	288	274	259	242	221	191	121
QF 50 - 28	-	9000003033	-	26	35	320	321	313	298	283	267	250	228	197	124
QF 50 - 29	-	9000003037	-	26	35	331	332	323	308	292	276	258	235	203	127
QF 50 - 30	-	9000003040	-	26	35	342	343	333	318	301	284	266	242	209	130
QF 50 - 31	-	9000003043	-	26	35	353	354	344	328	310	293	274	249	215	133
QF 50 - 32	-	9000003046	9000003047	30	40	367	368	358	342	324	306	287	262	227	143
QF 50 - 33	-	9000003050	9000003052	30	40	378	379	369	352	334	315	295	269	232	146
QF 50 - 34	-	9000003053	9000003054	30	40	389	390	379	362	343	324	303	276	238	149
QF 50 - 35	-	9000003055	9000003057	30	40	399	401	390	372	352	332	310	283	244	152
QF 50 - 39	-	9000008074	9000012064	37	50	445	447	435	416	395	374	351	320	278	176
QF 50 - 43	-	9000011314	9000015389	37	50	489	491	478	456	433	409	383	350	303	190
QF 50 - 46	-	-	9000003068	45	60	531	535	521	499	475	451	424	389	341	220
QF 50 - 49	-	-	9000011613	45	60	565	568	554	530	504	478	450	413	361	233
QF50 - 52	-	-	-	55	75	600	603	588	562	535	507	478	438	383	247
QF50 - 54	-	-	-	55	75	623	626	611	584	555	527	496	455	398	257

PERFORMANCE CURVE

SUBMERSIBLE PUMP QF 50

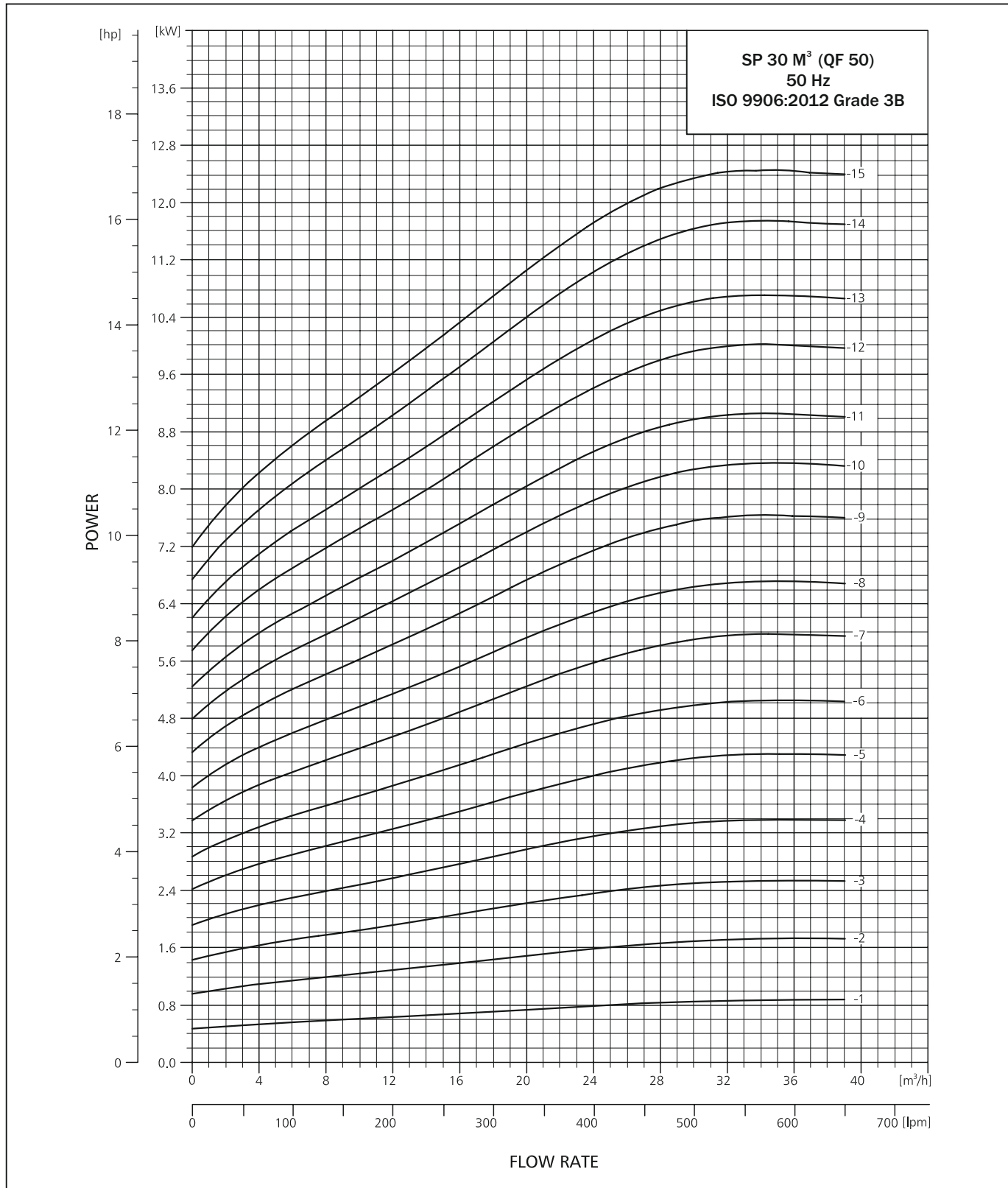

PERFORMANCE CURVE

SUBMERSIBLE PUMP QF 50

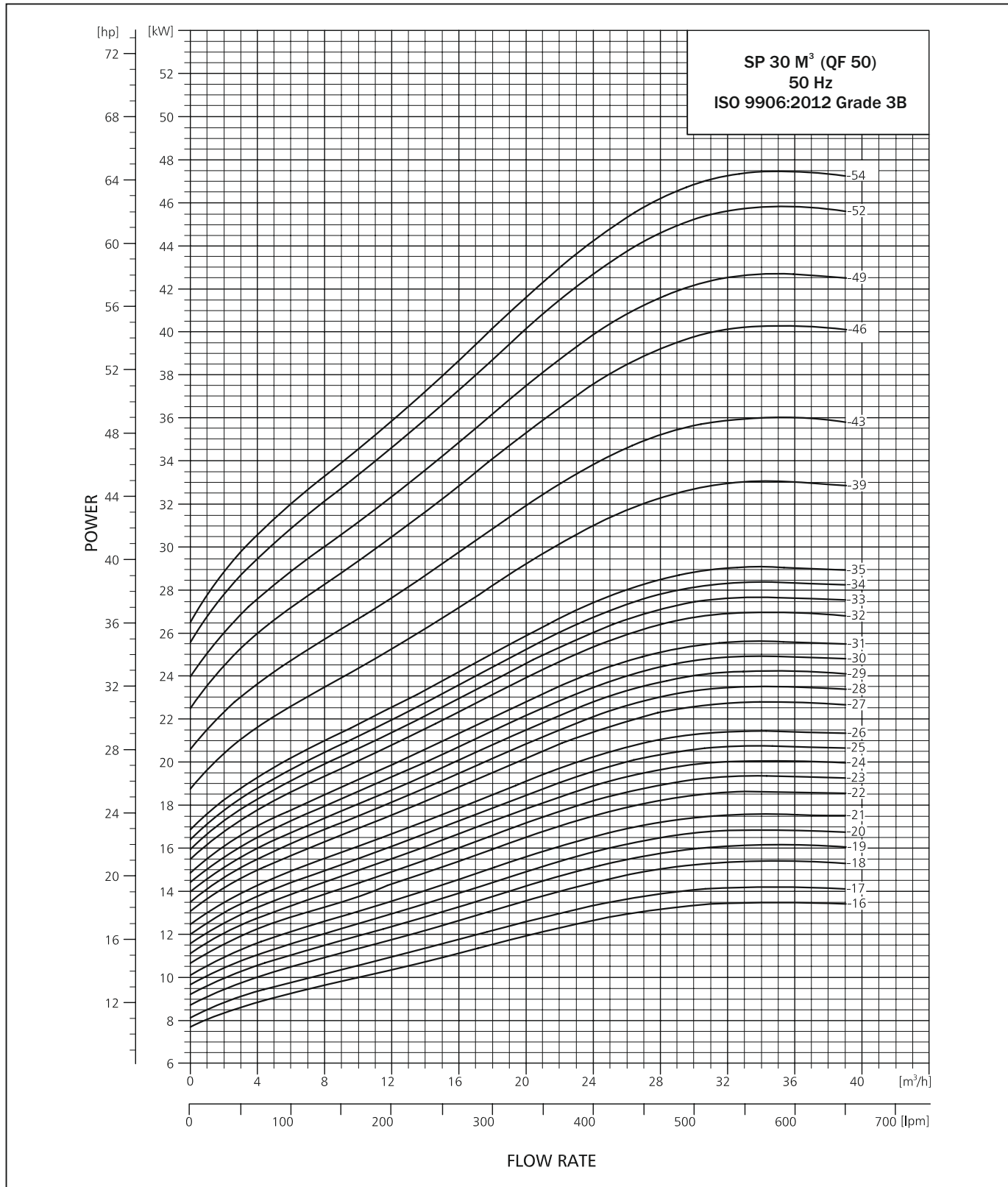

PERFORMANCE CURVE



SUBMERSIBLE PUMP QF 60

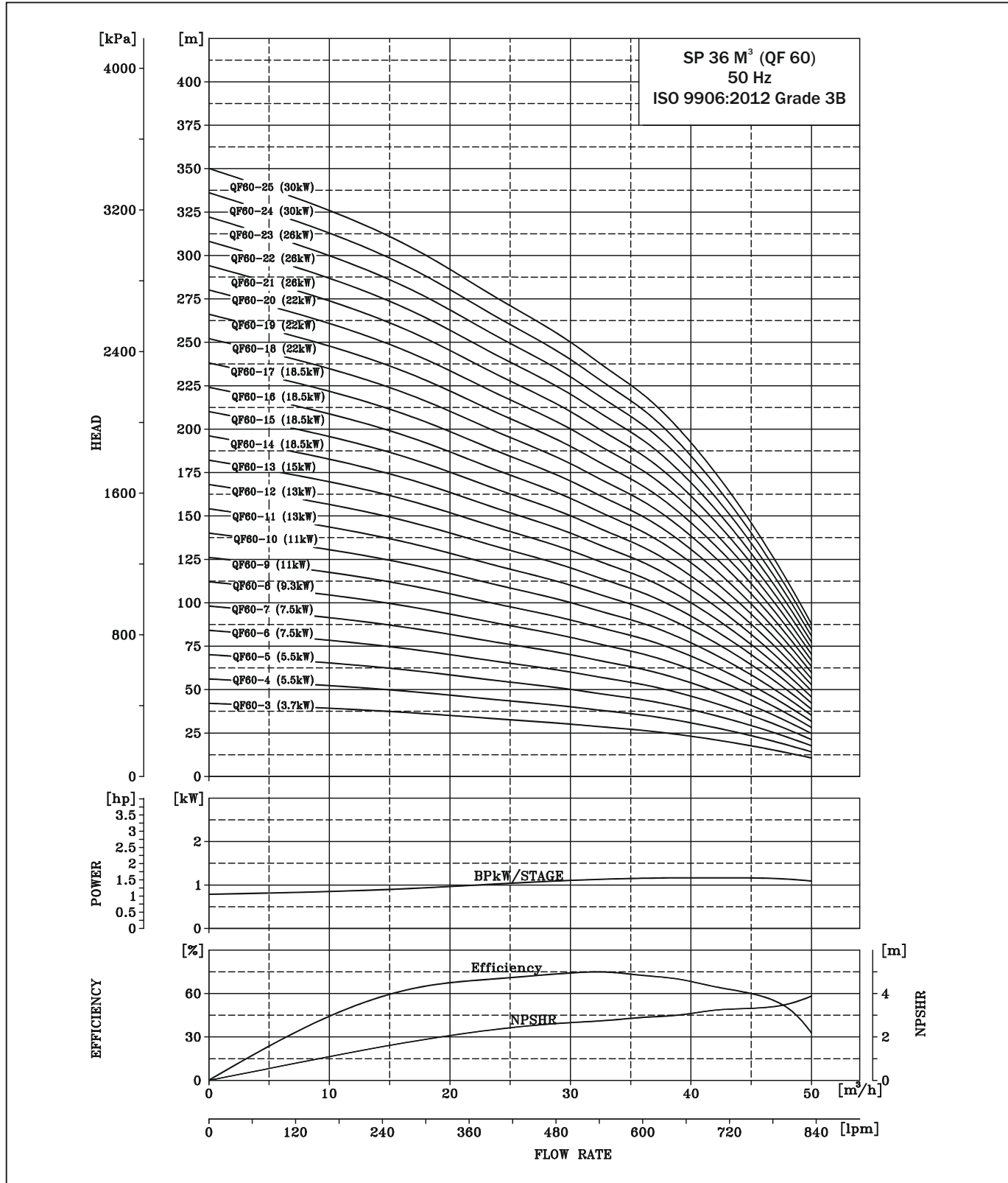

SUBMERSIBLE PUMP QF 60

DIMENSIONS AND WEIGHTS

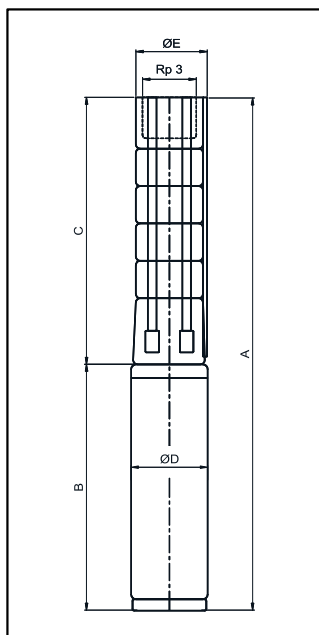

E = Maximum diameter of pump inclusive of cable guard & motor.

TECHNICAL DATA QF 60

PUMP TYPE	MOTOR		DIMENSIONS (mm)					NET WEIGHT (kg)	
	TYPE	POWER (kW)	Rp 3" CONNECTION				D	PUMP	MOTOR
			A	B	C	E*			
QF60-3	PREM 101	4	1240	690	550	143	95	12	31
QF60-4	PREM 101	5.5	1402	767	635	143	95	14	35
QF60-5	PREM 101	5.5	1487	767	720	143	95	16	35
QF60-6	PREM 101	7.5	1630	825	805	143	95	18	38
QF60-7	PREM 101	7.5	1715	825	890	143	95	20	38
QF60-3	MATASF 150	4	1249	699	550	145	145	13	34
QF60-4	MATASF 150	5.5	1334	699	635	145	145	15	37
QF60-5	MATASF 150	5.5	1419	699	720	145	145	17	37
QF60-6	MATASF 150	7.5	1524	719	805	145	145	19	42
QF60-7	MATASF 150	7.5	1609	719	890	145	145	21	42
QF60-8	MATASF 150	9.3	1724	749	975	145	145	23	46
QF60-9	MATASF 150	11	1840.5	779	1061.5	145	145	25	47
QF60-10	MATASF 150	11	1927	779	1148	145	145	27	47
QF60-11	MATASF 150	13	2062	829	1233	145	145	29	55
QF60-12	MATASF 150	13	2147	829	1318	145	145	31	55
QF60-13	MATASF 150	15	2277	874	1403	145	145	33	61
QF60-14	MTSF150	18.5	2407	919	1488	145	145	35	73
QF60-15	MTSF150	18.5	2492	919	1573	145	145	37	73
QF60-16	MTSF150	18.5	2577	919	1658	145	145	39	73
QF60-17	MTSF150	18.5	2662	919	1743	145	145	41	73
QF60-18	MTSF150	22	2837	1009	1828	145	145	43	82
QF60-19	MTSF150	22	2922	1009	1913	145	145	45	82
QF60-20	MTSF150	22	3007	1009	1998	145	145	47	82
QF60-21	MTSF150	26	3197	1114	2083	145	145	49	98
QF60-22	MTSF150	26	3282	1114	2168	145	145	51	98
QF60-23	MTSF150	26	3367	1114	2253	145	145	53	98
QF60-24	MTSF150	30	3552	1214	2338	145	145	55	107
QF60-25	MTSF150	30	3637	1214	2423	145	145	57	107

* Maximum diameter of pump with one motor cable.
Motor type may change as per requirement.

SUBMERSIBLE PUMP QF 60

PERFORMANCE TABLE QF 60

QF-60			DISCHARGE (Q)											
			m ³ /h	0	18	24	30	33	36	39	42	48	51	
			l/min.	0	300	400	500	550	600	650	700	800	850	
MODEL	CONNECTION	MATERIAL CODE	MOTOR RATING		TOTAL HEAD IN (m)									
		6X6	[kW]	[HP]										
QF60- 3	Rp 3	9000027478	3.7	5	42	36	33	30	28	26	24	20	12	8
QF60- 4		9000027479	5.5	7.5	56	48	44	40	37	34	32	26	16	10
QF60- 5		9000026650	5.5	7.5	70	60	55	50	47	43	40	33	20	13
QF60- 6		9000027480	7.5	10	84	72	66	60	56	51	48	39	24	16
QF60- 7		9000027481	7.5	10	98	83	77	69	65	60	56	46	28	18
QF60- 8		9000027482	9.3	12.5	112	95	88	79	75	68	64	52	32	21
QF60- 9		9000027483	11	15	126	107	99	89	84	77	72	59	36	23
QF60- 10		9000027484	11	15	140	119	110	99	93	85	80	66	40	26
QF60- 11		9000027485	13	17.5	154	131	120	109	103	94	87	72	44	29
QF60- 12		9000027486	13	17.5	168	143	131	119	112	103	95	79	48	31
QF60- 13		9000027487	15	20	182	155	142	129	121	111	103	85	52	34
QF60- 14		9000027488	18.5	25	196	167	153	139	131	120	111	92	55	36
QF60- 15		9000027489	18.5	25	210	179	164	149	140	128	119	98	59	39
QF60- 16		9000027490	18.5	25	224	191	175	159	149	137	127	105	63	42
QF60- 17		9000027492	18.5	25	238	203	186	169	159	145	135	111	67	44
QF60- 18		9000027493	22	30	252	215	197	179	168	154	143	118	71	47
QF60- 19		9000027494	22	30	266	226	208	189	177	162	151	124	75	49
QF60- 20		9000027495	22	30	280	238	219	198	187	171	159	131	79	52
QF60- 21		9000027496	26	35	294	250	230	208	196	179	167	138	83	55
QF60- 22		9000027497	26	35	308	262	241	218	205	188	175	144	87	57
QF60- 23		9000027498	26	35	322	274	252	228	215	197	183	151	91	60
QF60- 24		9000027499	30	40	336	286	263	238	224	205	191	157	95	62
QF60- 25		9000027500	30	40	350	298	274	248	233	214	199	164	99	65

PERFORMANCE CURVE



SUBMERSIBLE PUMP QF 75

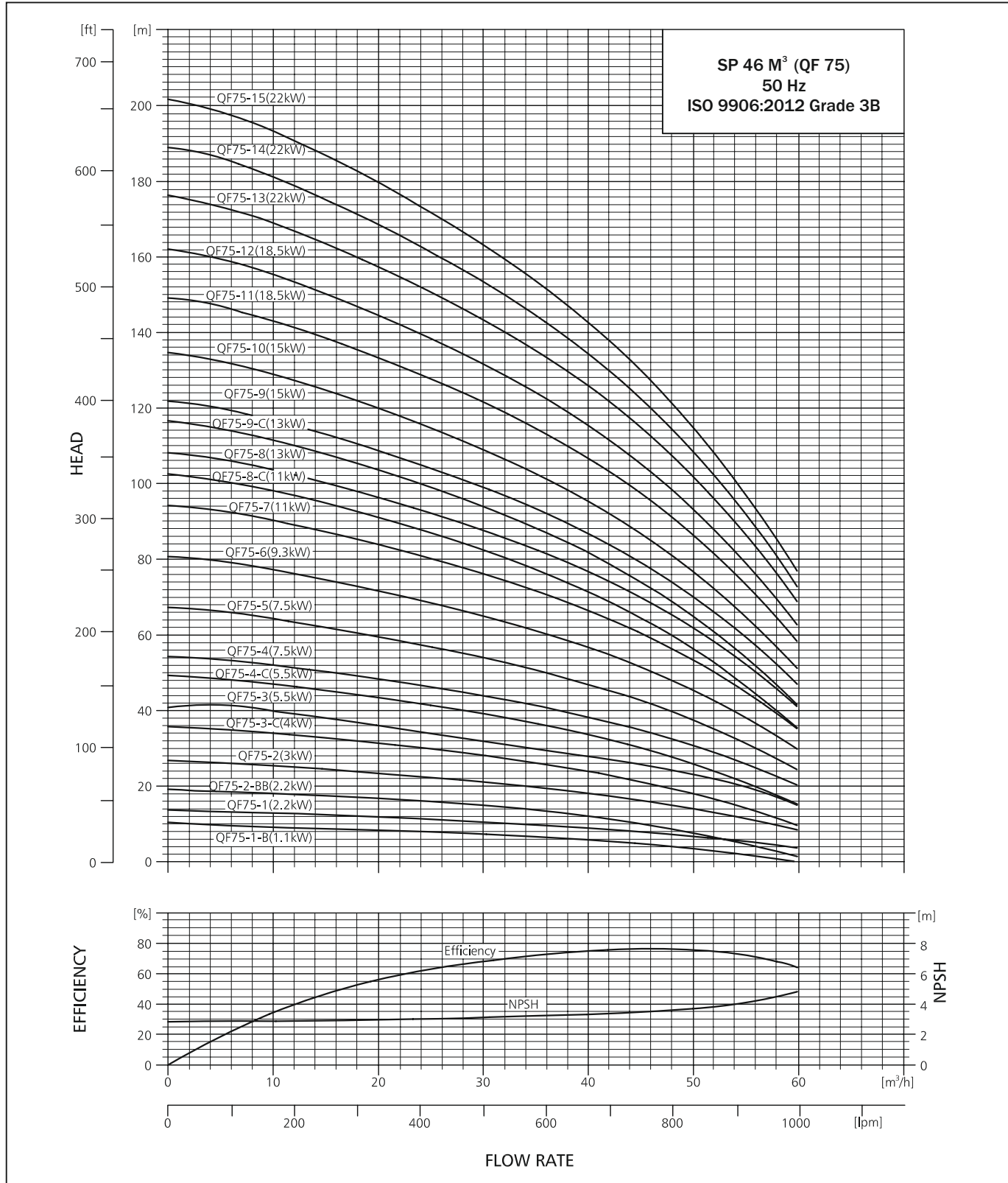

PERFORMANCE CURVE



SUBMERSIBLE PUMP QF 75

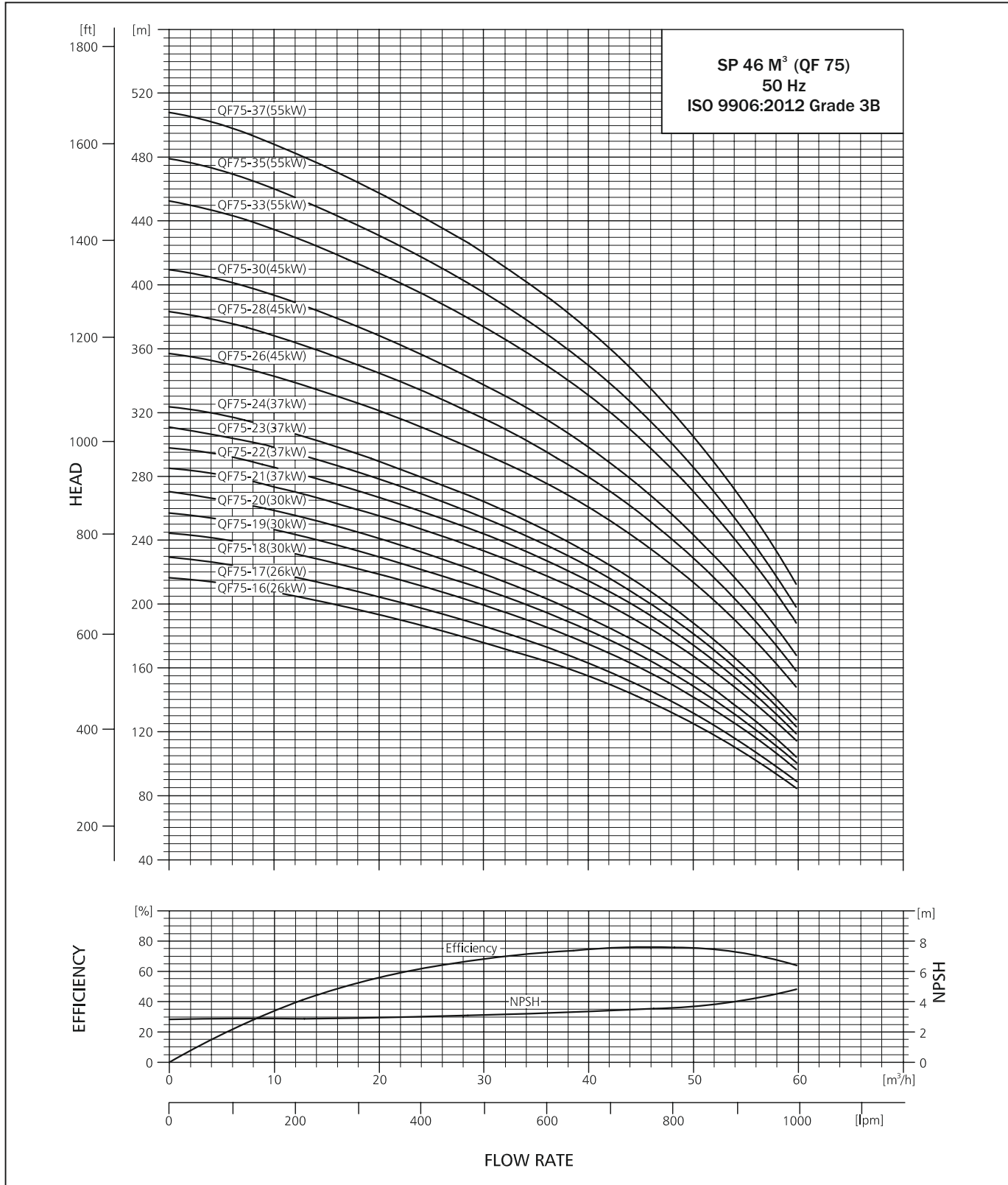

SUBMERSIBLE PUMP QF 75

DIMENSIONS AND WEIGHTS

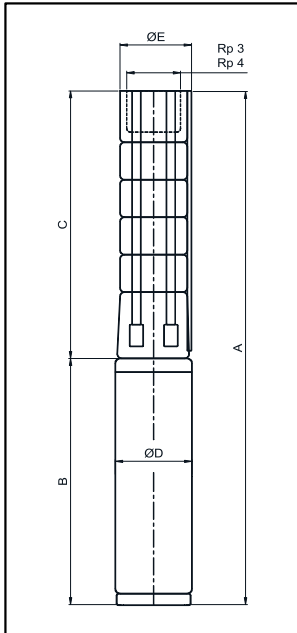

E = Maximum diameter of pump inclusive of cable guard & motor.

TECHNICAL DATA QF 75

PUMP TYPE	MOTOR		DIMENSIONS (mm)										NETWEIGHT(kg)	
	TYPE	POWER (kW)	Rp 3" CONNECTION				Rp 4" CONNECTION				B	D	PUMP	MOTOR
			A	C	E*	E**	A	C	E*	E**				
QF75-1-B	PREMIUM 100	1.1	715	376	138	-	715	376	138	-	339	95	7.8	15
QF75-1	PREMIUM 100	2.2	914	376	138	-	914	376	138	-	538	95	7.8	24
QF75-2-BB	PREMIUM 100	2.2	1027	489	138	-	1027	489	138	-	538	95	10.0	24
QF75-2	PREMIUM 100	3.0	1067	489	138	-	1067	489	138	-	578	95	10.0	26
QF75-3-C	PREMIUM 100	4.0	1292	602	138	-	1292	602	138	-	690	95	12.2	31
QF75-3	PREMIUM 100	5.5	1369	602	138	-	1369	602	138	-	767	95	12.2	35
QF75-4-C	PREMIUM 100	5.5	1482	715	138	-	1482	715	138	-	767	95	14.4	35
QF75-4	PREMIUM 100	7.5	1540	715	138	-	1540	715	138	-	825	95	14.4	38
QF75-5	PREMIUM 100	7.5	1653	828	138	-	1653	828	138	-	825	95	16.6	38
QF75-3-C	MATASF 150	4.0	1313	614	145	145	1313	614	145	145	699	145	14.2	51
QF75-3	MATASF 150	5.5	1313	614	145	145	1313	614	145	145	699	145	14.2	51
QF75-4-C	MATASF 150	5.5	1426	727	145	145	1426	727	145	145	699	145	16.4	51
QF75-4	MATASF 150	7.5	1446	727	145	145	1446	727	145	145	719	145	16.4	54
QF75-5	MATASF 150	7.5	1559	840	145	145	1559	840	145	145	719	145	18.6	54
QF75-6	MATASF 150	9.3	1702	953	145	145	1702	953	145	145	749	145	20.8	57
QF75-7	MATASF 150	11	1845	1066	145	145	1845	1066	145	145	779	145	23.0	59
QF75-8C	MATASF 150	11	1958	1179	145	145	1958	1179	145	145	779	145	25.2	59
QF75-8	MATASF 150	13	2008	1179	145	145	2008	1179	145	145	829	145	25.2	64
QF75-9C	MATASF 150	13	2121	1292	145	145	2121	1292	145	145	829	145	27.4	64
QF75-9	MATASF 150	15	2166	1292	145	145	2166	1292	145	145	874	145	27.4	70
QF75-10	MATASF 150	15	2279	1405	145	145	2279	1405	145	145	874	145	29.6	70
QF75-11	MATASF 150	18.5	2437	1518	145	145	2437	1518	145	145	919	145	31.8	73
QF75-12	MATASF 150	18.5	2550	1631	145	145	2550	1631	145	145	919	145	34.0	73
QF75-13	MATASF 150	22	2753	1744	145	145	2753	1744	145	145	1009	145	36.2	82
QF75-14	MATASF 150	22	2866	1857	145	145	2866	1857	145	145	1009	145	38.4	82
QF75-15	MATASF 150	22	2979	1970	145	145	2979	1970	145	145	1009	145	40.6	82
QF75-16	MATASF 150	26	3197	2083	145	145	3197	2083	145	145	1114	145	42.8	98
QF75-17	MATASF 150	26	3310	2196	145	145	3310	2196	145	145	1114	145	45.0	98
QF75-18	MATASF 150	30	3523	2309	145	145	3523	2309	145	145	1214	145	47.2	107
QF75-19	MATASF 150	30	3636	2422	145	145	3636	2422	145	145	1214	145	49.4	107
QF75-20	MATASF 150	30	3749	2535	145	145	3749	2535	145	145	1214	145	51.6	107
QF75-18	MATASF 200	30	3484	2344	194	194	3484	2344	194	194	1140	194	51.4	164
QF75-19	MATASF 200	30	3597	2457	194	194	3597	2457	194	194	1140	194	53.7	164
QF75-20	MATASF 200	30	3710	2570	194	194	3710	2570	194	194	1140	194	56.0	164
QF75-21	MATASF 200	37	3823	2683	194	194	3823	2683	194	194	1140	194	58.3	164
QF75-22	MATASF 200	37	3936	2796	194	194	3936	2796	194	194	1140	194	60.6	164
QF75-23	MATASF 200	37	4049	2909	194	194	4049	2909	194	194	1140	194	62.9	164
QF75-24	MATASF 200	37	4162	3022	194	194	4162	3022	194	194	1140	194	65.2	164
QF75-26	MATASF 200	45	4478	3248	194	194	4478	3248	194	194	1230	194	69.8	189
QF75-28	MATASF 200	45	4704	3474	194	194	4704	3474	194	194	1230	194	74.4	189
QF75-30	MATASF 200	45	4930	3700	194	194	4930	3700	194	194	1230	194	79.0	189
QF75-33	MATASF 200	55	5379	4039	194	194	5379	4039	194	194	1340	194	85.9	203
QF75-35	MATASF 200	55	5605	4265	194	194	5605	4265	194	194	1340	194	90.5	203
QF75-37	MATASF 200	55	5831	4491	194	194	5831	4491	194	194	1340	194	95.1	203

* Maximum diameter of pump with one motor cable.

** Maximum diameter of pump with two motor cable.

Motor type may change as per requirement.

Other type of connection is possible by means of connecting pieces. See page no. 117.

SUBMERSIBLE PUMP QF 75

PERFORMANCE TABLE QF 75

QF-75		DISCHARGE (Q)																		
		m ³ /h		0	5	10	15	20	25	30	35	40	45	50	55	59.8				
		l/min.		0	83.3	166.7	250	333.3	416.7	500	583.3	666.7	750	833.3	916.7	996.7				
MODEL	MATERIAL CODE			MOTOR RATING		TOTAL HEAD IN (m)														
	4x6	6x6	8x6	[kW]	[HP]	14	13	13	12	12	11	11	10	9	8	7	6	5		
QF 75- 1	9000003082	-	-	2.2	3	14	13	13	12	12	11	11	10	9	8	7	6	5		
QF 75- 2-BE	9000003137	-	-	2.2	3	19	19	18	17	17	16	15	14	12	10	8	5	1		
QF 75- 2	9000003121	-	-	3	4	27	26	25	24	23	22	21	20	18	16	14	11	9		
QF 75- 3-C	9000003150	-	-	4	5.5	36	35	34	33	31	30	28	26	24	21	18	14	10		
QF 75- 3	9000003140	-	-	5.5	7.5	41	41	40	38	36	34	32	30	28	26	23	20	15		
QF 75- 4-C	9000003156	-	-	5.5	7.5	49	48	47	45	43	41	39	37	34	30	26	21	15		
QF 75- 4	9000003151	-	-	7.5	10	54	53	52	50	48	46	44	41	38	35	31	26	20		
QF 75- 5	9000003158	-	-	7.5	10	67	66	64	62	60	57	54	51	47	43	37	31	24		
QF 75- 6	-	-	-	9.3	12.5	81	79	77	75	72	68	65	61	57	51	45	38	30		
QF 75- 7	-	-	-	11	15	94	93	90	87	84	80	76	72	66	60	53	45	35		
QF 75- 8-C	-	-	-	11	15	103	101	98	95	91	87	82	77	71	64	56	46	36		
QF 75- 8	-	-	-	13	17.5	108	106	104	100	96	92	88	83	77	70	62	52	41		
QF 75- 9-C	-	-	-	13	17.5	117	115	112	108	104	99	94	88	82	74	65	54	42		
QF 75- 9	-	-	-	15	20	122	120	117	113	109	104	99	93	87	79	70	59	47		
QF 75- 10	-	9000003085	-	15	20	135	132	129	125	120	115	109	103	95	87	77	65	51		
QF 75- 11	-	9000003089	-	18.5	25	149	147	143	138	133	128	122	115	107	97	86	73	59		
QF 75- 12	-	9000003092	-	18.5	25	162	159	155	150	145	138	132	124	115	105	93	79	63		
QF 75- 13	-	9000003095	-	22	30	176	173	169	163	157	151	143	135	126	115	102	86	69		
QF 75- 14	-	9000003098	-	22	30	189	186	181	175	169	161	153	144	134	122	108	92	73		
QF 75- 15	-	9000003101	-	22	30	202	198	193	187	180	172	163	154	143	130	115	97	77		
QF 75- 16	-	9000003104	-	26	35	217	213	208	201	193	185	176	166	155	141	125	106	85		
QF 75- 17	-	9000003107	-	26	35	229	226	220	213	205	196	186	175	163	149	132	112	89		
QF 75- 18	-	9000003110	9000003111	30	40	244	241	234	227	219	209	199	188	175	160	142	121	97		
QF 75- 19	-	9000003114	9000003115	30	40	257	253	247	239	230	220	209	197	183	167	148	126	101		
QF 75- 20	-	9000003125	9000003126	30	40	270	265	259	251	241	230	219	206	192	175	155	132	105		
QF 75- 21	-	9000009825	9000003127	37	50	285	280	273	265	255	245	234	221	206	188	167	143	115		
QF 75- 22	-	9000003128	9000003129	37	50	298	293	286	277	267	256	244	230	215	196	174	148	119		
QF 75- 23	-	9000010370	9000003130	37	50	311	306	298	289	278	267	254	240	223	204	181	154	124		
QF 75- 24	-	9000003132	9000003133	37	50	324	318	310	300	289	277	264	249	232	212	188	160	128		
QF 75- 26	-	-	9000010933	45	60	357	351	343	332	321	308	295	279	261	239	214	183	149		
QF 75- 28	-	-	9000008080	45	60	383	377	368	357	345	331	316	299	280	256	229	196	159		
QF 75- 30	-	-	9000008081	45	60	410	403	393	381	368	353	337	319	298	273	244	208	169		
QF 75- 33	-	-	9000008082	55	75	452	445	435	422	407	391	374	354	331	303	271	232	189		
QF 75- 35	-	-	-	55	75	479	472	461	448	432	415	397	375	351	321	287	246	200		
QF 75- 37	-	-	-	55	75	507	499	488	473	456	438	419	397	371	340	304	260	212		

PERFORMANCE CURVE



SUBMERSIBLE PUMP QF 75

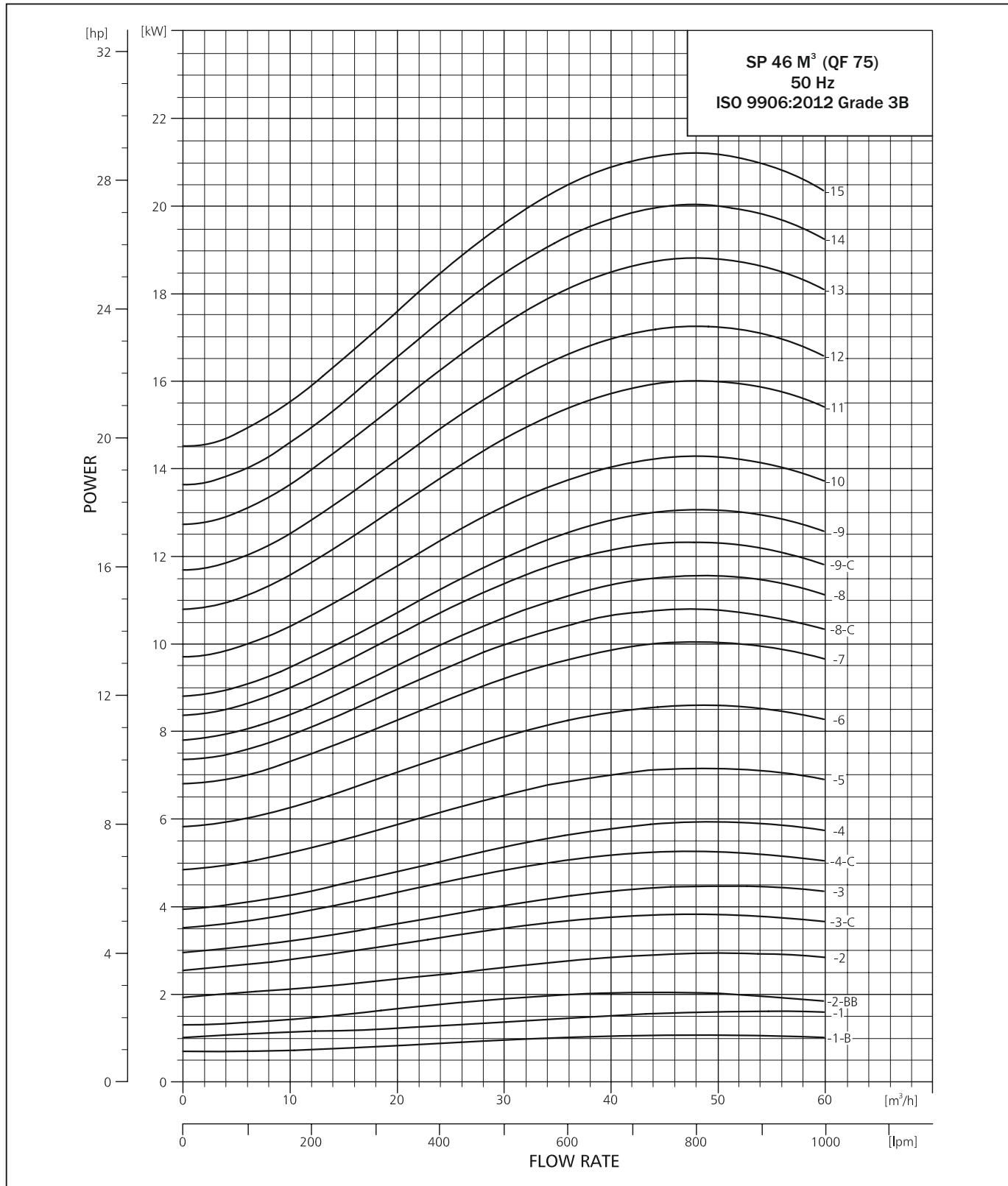

PERFORMANCE CURVE

SUBMERSIBLE PUMP QF 75

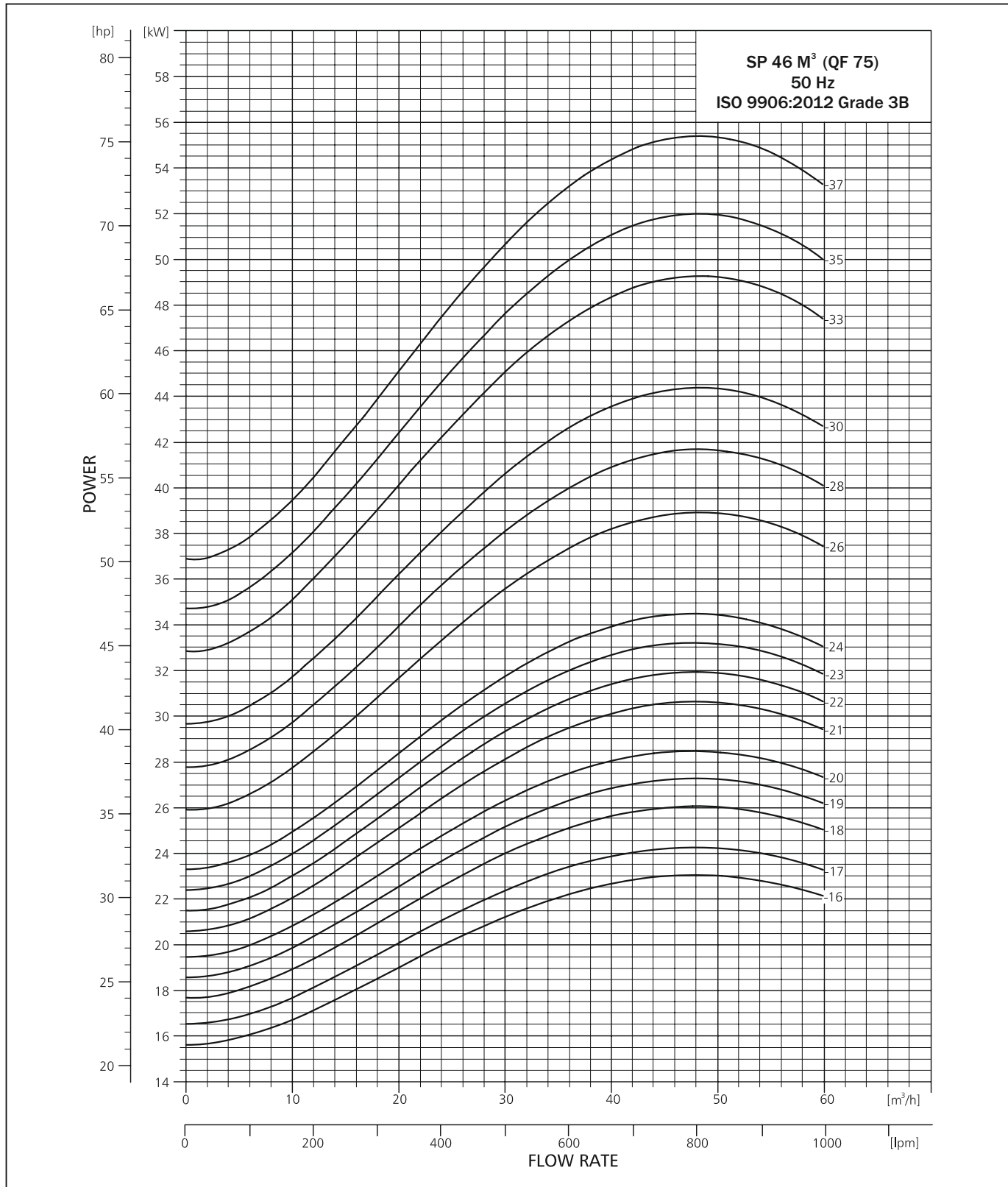

PERFORMANCE CURVE



SUBMERSIBLE PUMP QF 100

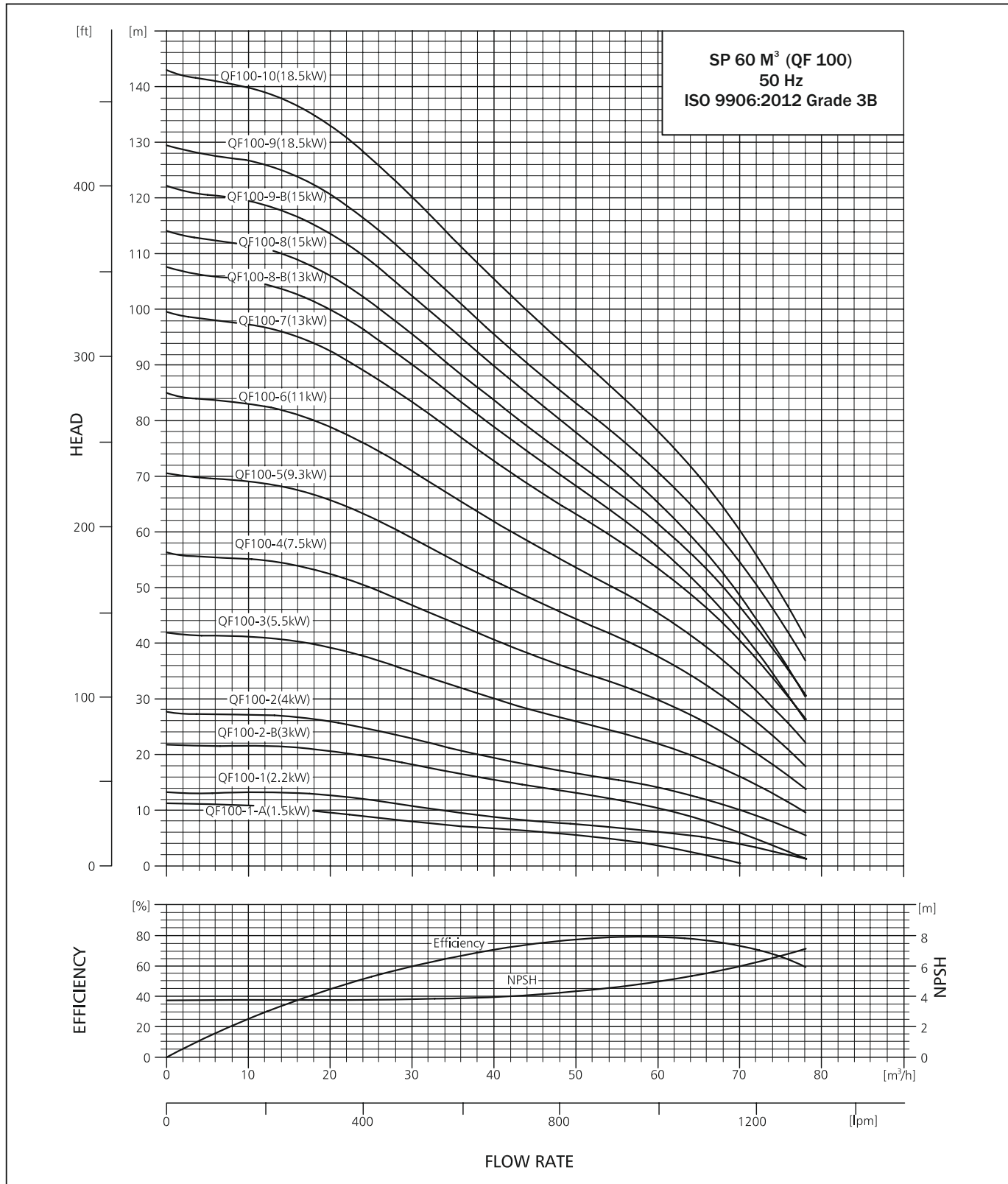

PERFORMANCE CURVE



SUBMERSIBLE PUMP QF 100

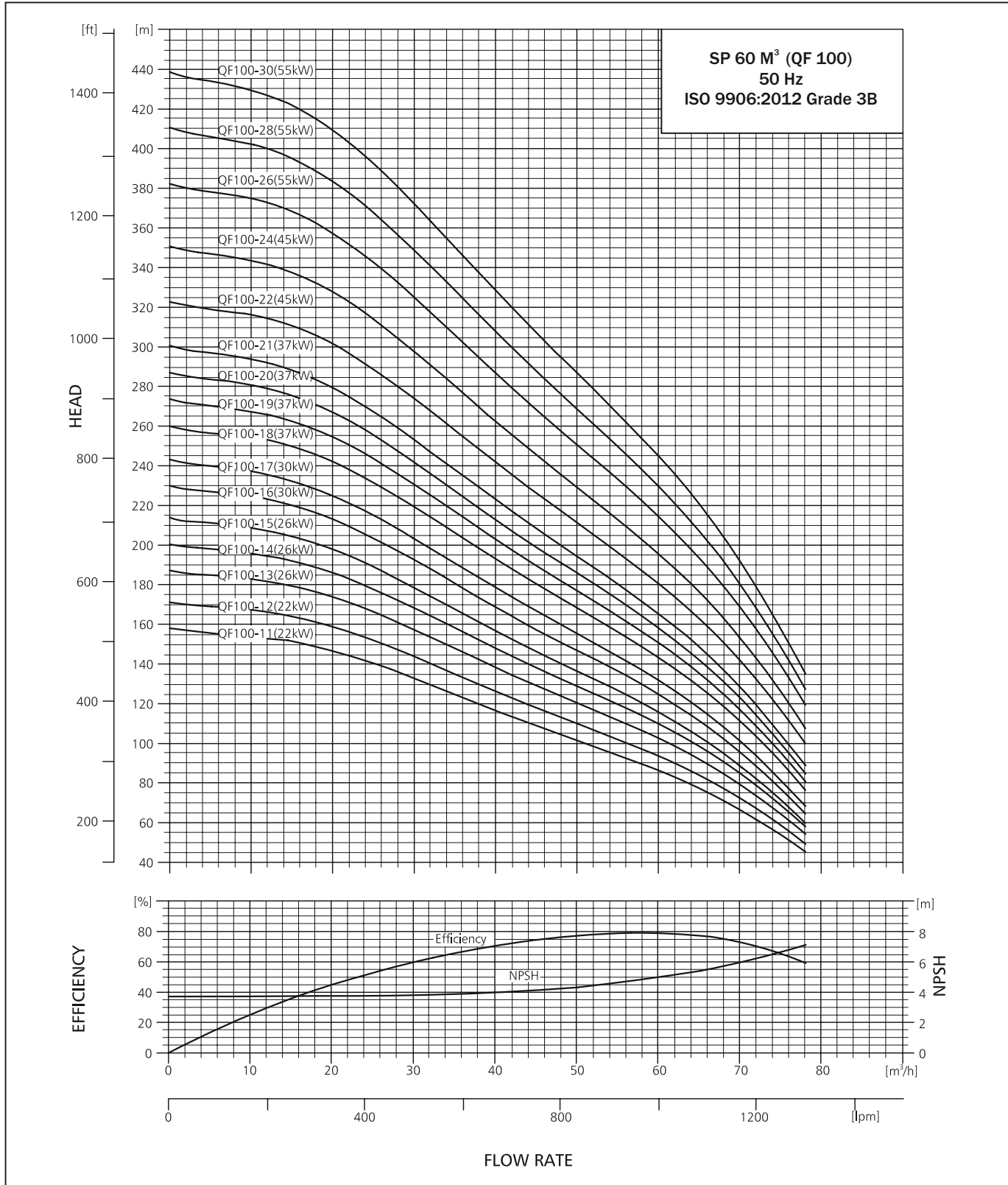

TECHNICAL DATA



SUBMERSIBLE PUMP QF 100

DIMENSIONS AND WEIGHTS

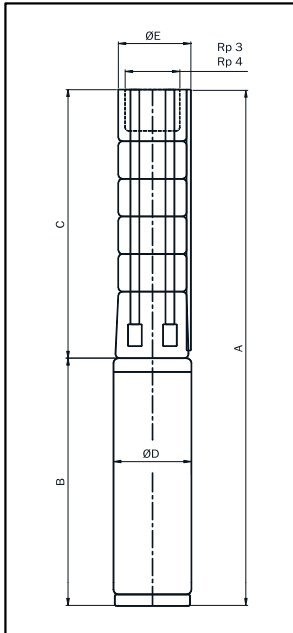

E = Maximum diameter of pump inclusive of cable guard & motor.

TECHNICAL DATA QF 100

PUMP TYPE	MOTOR		DIMENSIONS (mm)										NET WEIGHT (kg)	
	TYPE	POWER (kW)	Rp 3" CONNECTION				Rp 4" CONNECTION				B	D	PUMP	MOTOR
			A	C	E*	E**	A	C	E*	E**				
QF100-1-A	PREMIUM 100	1.5	780	376	138	-	780	376	138	-	404	95	7.8	17
QF100-1	PREMIUM 100	2.2	914	376	138	-	914	376	138	-	538	95	7.8	24
QF100-2-B	PREMIUM 100	3.0	1067	489	138	-	1067	489	138	-	578	95	10.0	26
QF100-2	PREMIUM 100	4.0	1179	489	138	-	1179	489	138	-	690	95	10.0	31
QF100-3	PREMIUM 100	5.5	1370	603	138	-	1370	603	138	-	767	95	12.2	35
QF100-4	PREMIUM 100	7.5	1540	715	145	145	1540	715	145	145	825	145	14.4	38
QF100-3	MATASF 150	5.5	1313	614	145	145	1313	614	145	145	699	145	14.2	51
QF100-4	MATASF 150	7.5	1446	727	145	145	1446	727	145	145	719	145	16.4	54
QF100-5	MATASF 150	9.3	1589	840	145	145	1589	840	145	145	749	145	18.6	57
QF100-6	MATASF 150	11	1732	953	145	145	1732	953	145	145	779	145	20.8	59
QF100-7	MATASF 150	13	1895	1066	145	145	1895	1066	145	145	829	145	23.0	64
QF100-8-B	MATASF 150	13	2008	1179	145	145	2008	1179	145	145	829	145	25.2	64
QF100-8	MATASF 150	15	2053	1179	145	145	2053	1179	145	145	874	145	25.2	70
QF100-9-B	MATASF 150	15	2166	1292	145	145	2166	1292	145	145	874	145	27.4	70
QF100-9	MATASF 150	18.5	2211	1292	145	145	2211	1292	145	145	919	145	27.4	73
QF100-10	MATASF 150	18.5	2324	1405	145	145	2324	1405	145	145	919	145	29.6	73
QF100-11	MATASF 150	22	2527	1518	145	145	2527	1518	145	145	1009	145	31.8	82
QF100-12	MATASF 150	22	2640	1631	145	145	2640	1631	145	145	1009	145	34.0	82
QF100-13	MATASF 150	26	2858	1744	145	145	2858	1744	145	145	1114	145	36.2	98
QF100-14	MATASF 150	26	2971	1857	145	145	2971	1857	145	145	1114	145	38.4	98
QF100-15	MATASF 150	26	3084	1970	145	145	3084	1970	145	145	1114	145	40.6	98
QF100-16	MATASF 150	30	3297	2083	145	145	3297	2083	145	145	1214	145	42.8	107
QF100-17	MATASF 150	30	3410	2196	145	145	3410	2196	145	145	1214	145	45.0	107
QF100-16	MATASF 200	30	3258	2118	194	194	3250	2110	194	194	1140	194	46.8	164
QF100-17	MATASF 200	30	3371	2231	194	194	3363	2223	194	194	1140	194	49.1	164
QF100-18	MATASF 200	37	3484	2344	194	194	3476	2336	194	194	1140	194	51.4	164
QF100-19	MATASF 200	37	3597	2457	194	194	3589	2449	194	194	1140	194	53.7	164
QF100-20	MATASF 200	37	3700	2560	194	194	3702	2562	194	194	1140	194	56.0	164
QF100-21	MATASF 200	37	3823	2683	194	194	3815	2675	194	194	1140	194	58.3	164
QF100-22	MATASF 200	45	4026	2796	194	194	4018	2788	194	194	1230	194	60.6	189
QF100-24	MATASF 200	45	4252	3022	194	194	4244	3014	194	194	1230	194	65.2	189
QF100-26	MATASF 200	55	4588	3248	194	194	4580	3240	194	194	1340	194	69.8	203
QF100-28	MATASF 200	55	4814	3474	194	194	4806	3466	194	194	1340	194	74.4	203
QF100-30	MATASF 200	55	5040	3700	194	194	5032	3692	194	194	1340	194	79.0	203

* Maximum diameter of pump with one motor cable.

** Maximum diameter of pump with two motor cable.

Motor type may change as per requirement.

Other type of connection is possible by means of connecting pieces. See page no. 117.

SUBMERSIBLE PUMP QF 100

PERFORMANCE TABLE QF 100

QF-100				DISCHARGE (Q)										
				m ³ /h	0	10	20	30	40	50	60	70	78	
				l/min.	0	166.7	333.3	500	666.7	833.3	1000	1166.7	1300	
MODEL	MATERIAL CODE			MOTOR RATING		TOTAL HEAD IN (m)								
	4x6	6x6	8x6	[kW]	[HP]									
QF 100 1-A	9000003229	-	-	1.5	2	12	11	10	8	6	5	4	1	0
QF 100 - 1	9000003179	9000017915	-	2.2	3	14	14	13	12	11	10	8	4	1.5
QF 100 -2-B	9000003241	-	-	3	4	22	22	21	18	15	13	10	6	1
QF 100 -2	9000003181	9000003231	-	4	5.5	28	27	26	23	19	17	14	10	5
QF 100 -3	9000011341	9000003244	-	5.5	7.5	42	41	39	35	30	26	22	16	10
QF 100 -4	9000003184	9000003249	-	7.5	10	56	55	52	47	41	35	30	22	14
QF 100 -5	-	9000003251	-	9.3	12.5	71	69	66	59	51	44	38	28	18
QF 100 -6	-	9000003254	-	11	15	85	83	79	71	62	54	45	34	22
QF 100 -7	-	9000003256	-	13	17.5	99	97	92	83	73	63	53	40	26
QF 100 -8-B	-	9000017852	-	13	17.5	108	105	100	90	79	68	57	42	26
QF 100 -8	-	9000003259	-	15	20	114	112	106	96	84	73	61	47	31
QF 100 -9-B	-	9000003263	-	15	20	122	119	113	102	90	78	65	48	30
QF 100 -9	-	9000003261	-	18.5	25	129	127	121	109	95	83	71	54	37
QF 100 -10	-	9000003197	-	18.5	25	143	140	133	120	105	92	78	60	41
QF 100 -11	-	9000003201	-	22	30	158	154	147	133	116	101	86	67	45
QF 100 -12	-	9000003204	-	22	30	171	167	159	144	126	110	94	72	50
QF 100 -13	-	9000003207	-	26	35	187	183	174	157	138	120	103	79	54
QF 100 -14	-	9000003210	-	26	35	200	196	186	168	148	129	110	85	58
QF 100 -15	-	9000003212	-	26	35	214	209	198	179	157	136	116	89	60
QF 100 -16	-	9000003216	9000003218	30	40	230	224	213	192	169	147	125	96	65
QF 100 -17	-	9000003219	9000003222	30	40	243	237	225	203	179	155	132	101	69
QF 100 -18	-	9000010511	9000003225	37	50	260	254	242	219	193	168	143	111	77
QF 100 -19	-	9000003226	9000003228	37	50	274	268	255	231	203	177	151	117	81
QF 100 -20	-	9000011316	9000003233	37	50	287	281	267	242	213	186	158	123	85
QF 100 -21	-	9000003236	9000003235	37	50	301	294	279	253	223	194	166	129	89
QF 100 -22	-	9000011318	9000003237	45	60	323	316	302	274	242	211	181	142	100
QF 100 -24	-	-	9000003238	45	60	352	345	329	299	264	230	197	155	109
QF 100 -26	-	-	9000003239	55	75	381	374	356	324	286	249	213	168	118
QF 100 -28	-	-	9000003240	55	75	411	402	384	349	308	269	230	181	127
QF 100 -30	-	-	9000003245	55	75	440	431	411	374	330	287	246	194	136

PERFORMANCE CURVE



SUBMERSIBLE PUMP QF 100

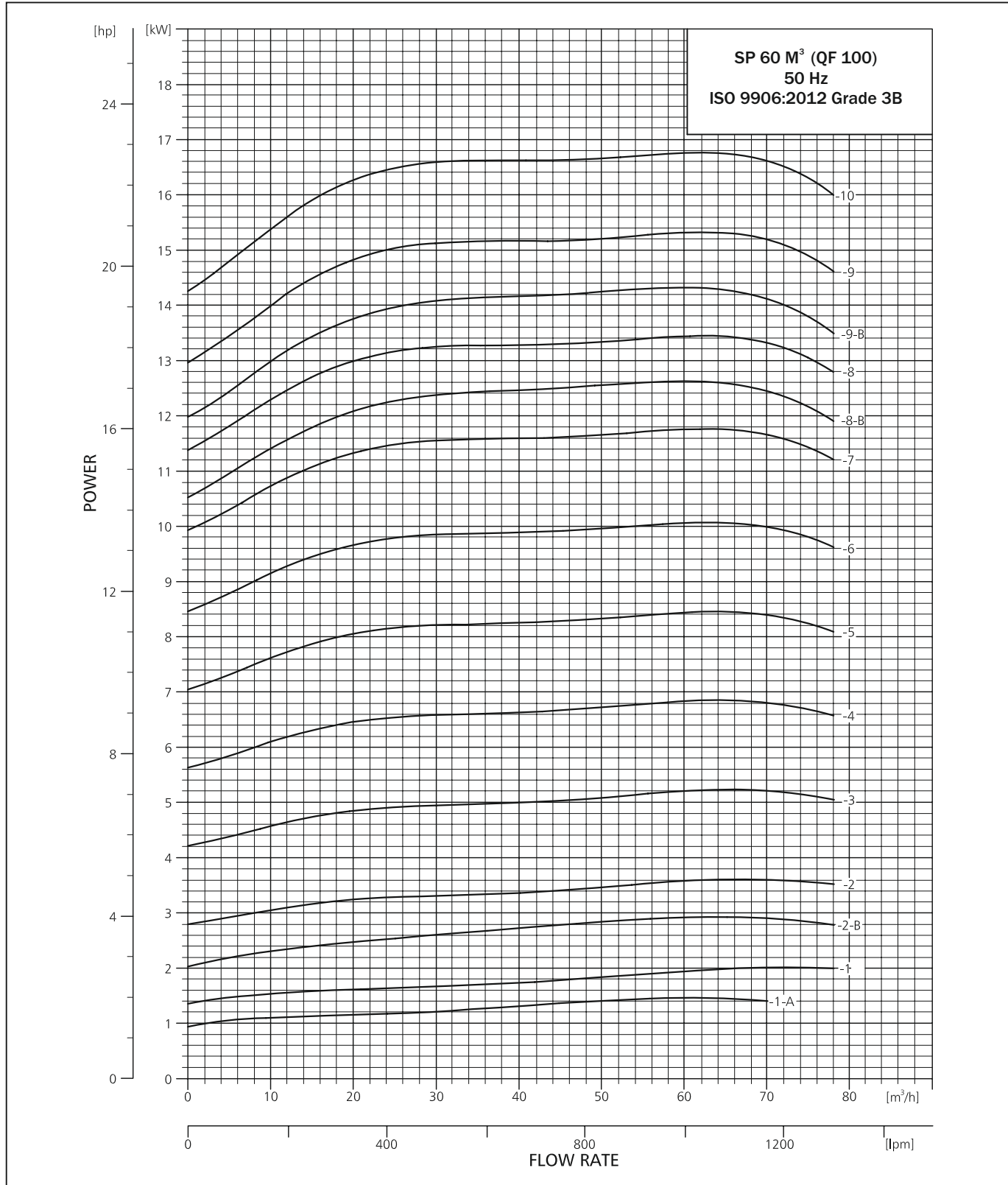

PERFORMANCE CURVE

SUBMERSIBLE PUMP QF 100

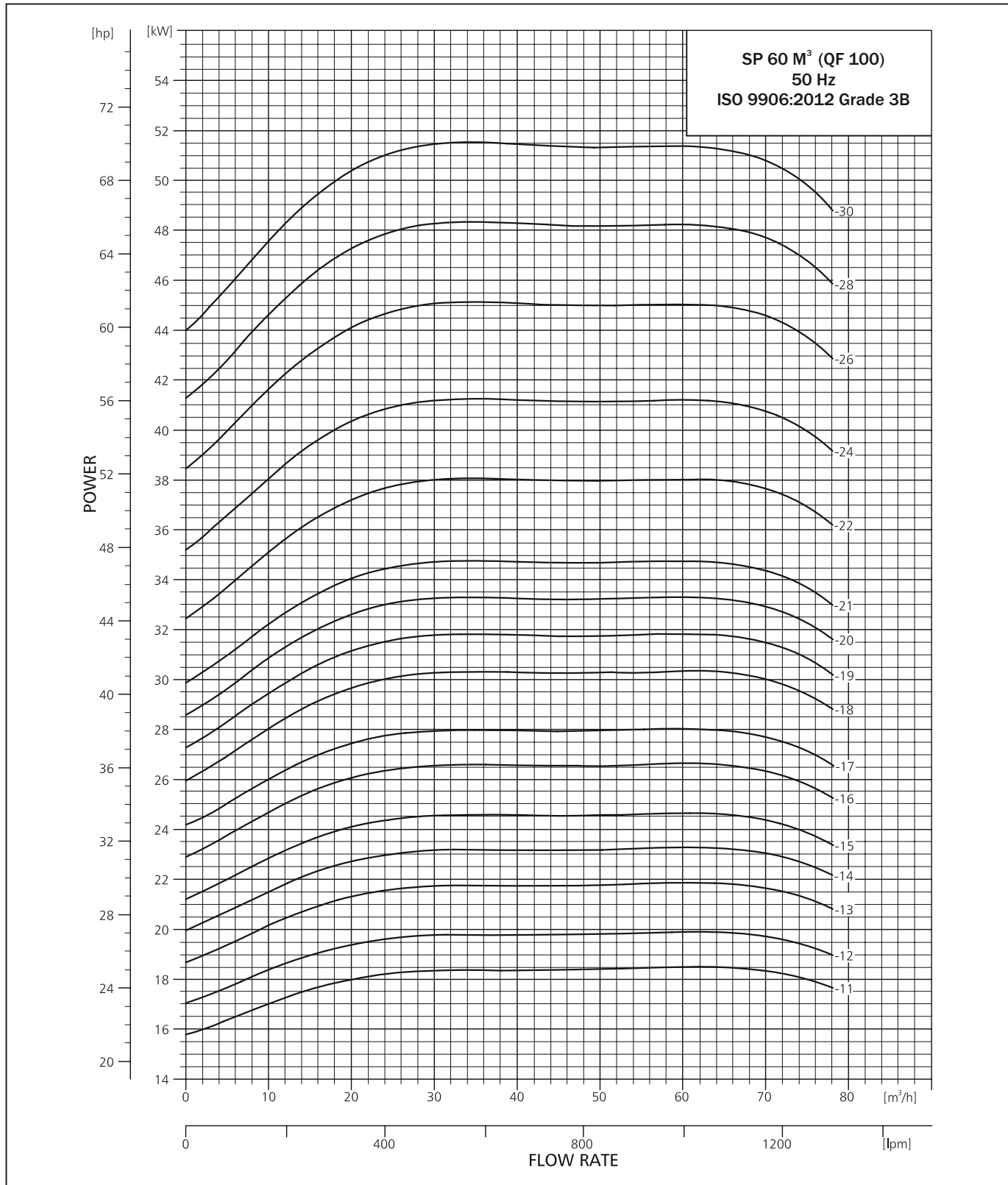

PERFORMANCE CURVE



SUBMERSIBLE PUMP QF 150

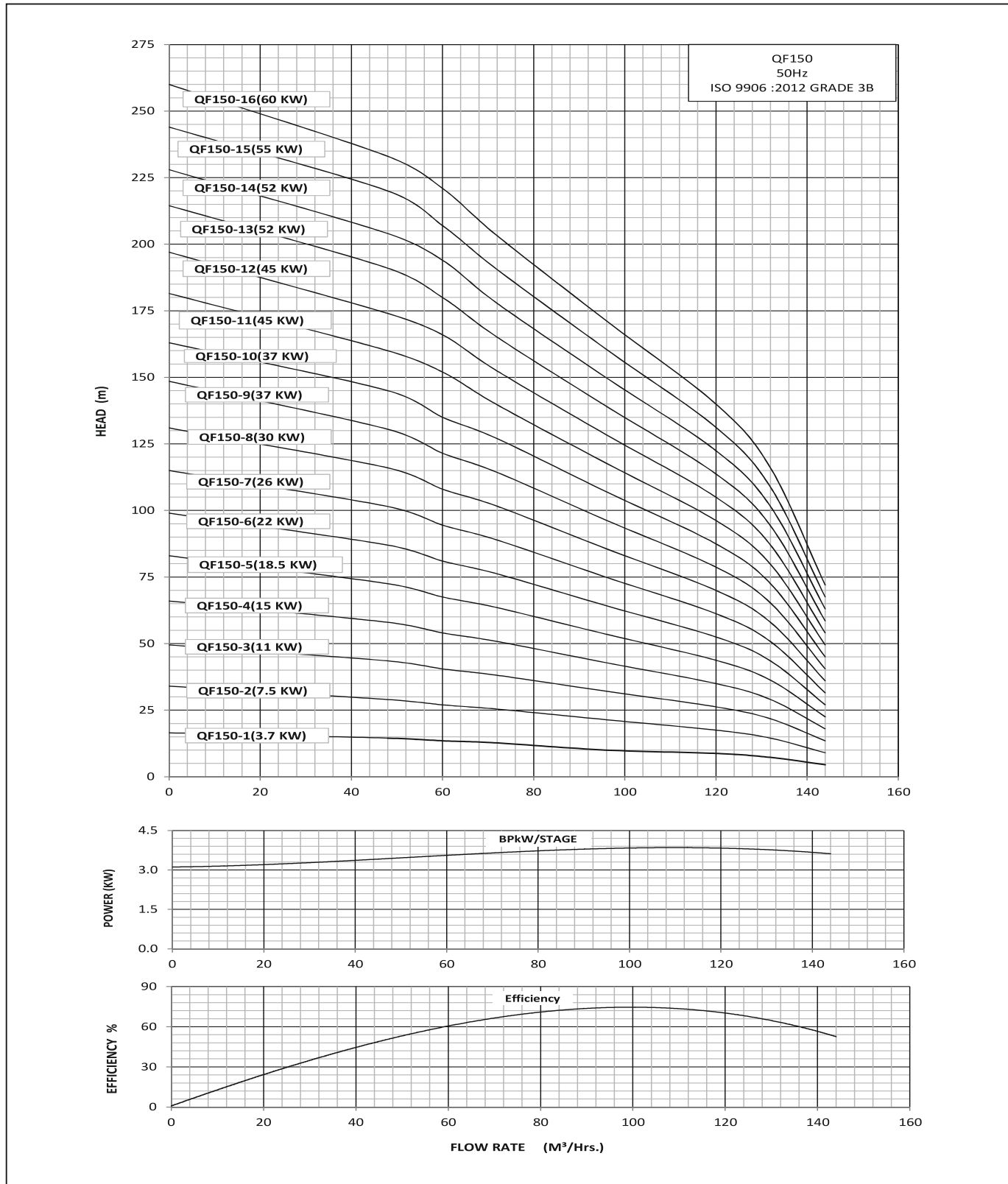

PERFORMANCE CURVE



SUBMERSIBLE PUMP QF 150

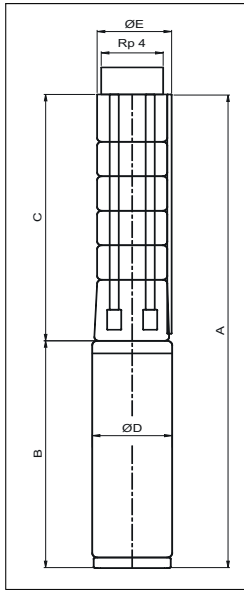

PUMP TYPE	MOTOR		DIMENSIONS (mm)								NET WEIGHT			
	TYPE	POWER (kW)	Rp 4" CONNECTION				Rp 4" FLANGE				B	D	PUMP	MOTOR
			A	C	E*	E**	A	C	E*	E**				
QF150-1	4"PREMIUM 100	3.7	1059	480	150	-	480	480	150	-	579	95	11	23
QF150-2	4"PREMIUM 100	7.5	1392	622	150	-	622	622	150	-	770	95	15	33
QF150-3	6" MTSF	11	1542	763	150	155	763	763	150	155	779	145	20	56
QF150-4	6" MTSF	15	1779	905	150	155	905	905	150	155	874	145	27	66
QF150-5	6" MTSF	18.5	1965	1046	150	155	1046	1046	150	155	919	145	31	70
QF150-6	6" MTSF	22	2197	1188	150	155	1188	1188	150	155	1009	145	38	79
QF150-7	6" MTSF	26	2443	1329	150	155	1329	1329	150	155	1114	145	41	90
QF150-8	6" MTSF	30	2685	1471	150	155	1471	1471	150	155	1214	145	45	100
QF150-9	6" MTSF	37	2826	1612	150	155	1612	1612	150	155	1214	145	45	172
QF150-10	6" MTSF	37	2968	1754	150	155	1754	1754	150	155	1214	145	45	172
QF150-11	6" MTSF	45	3125	1895	150	155	3125	1895	150	155	1230	145	47	188
QF150-12	8" MTSF	45	3295	2065	195	195	2065	2065	195	195	1230	195	64	188
QF150-13	8" MTSF	52	3546	2206	195	195	2206	2206	195	195	1340	195	68	203
QF150-14	8" MTSF	52	3688	2348	195	195	2348	2348	195	195	1340	195	73	203
QF150-15	8" MTSF	55	3829	2489	195	195	2489	2489	195	195	1340	195	84	211
QF150-16	8" MTSF	60	4101	2631	195	195	2631	2631	195	195	1470	195	89	245

* Maximum diameter of pump with one motor cable.
 ** Maximum diameter of pump with two motor cable.
 Motor type may change as per requirement.

PERFORMANCE TABLE QF 150

QF 150				DISCHARGE (Q)										
				M ³ /Hr	0	48	60	72	96	120	132	144		
				LPM	0	800	1000	1200	1600	2000	2200	2400		
MODEL	CONNECTION	MATERIAL CODE (6X8)	MATERIAL CODE (8X8)	MOTOR RATING		TOTAL HEAD IN (m)								
				(kW)	(HP)									
QF150-1	Rp 4"	9000022355		3.7	5	17	15	14	13	10	9	7	5	
QF150-2		9000022356		7.5	10	34	29	27	25	21	18	15	9	
QF150-3		9000022357		11	15	50	44	41	38	32	26	22	14	
QF150-4		9000022358		15	20	66	58.0	54.0	51	43	35	29	18	
QF150-5		9000022352		18.5	25	83	73	68	64	54	44	36	23	
QF150-6		9000022359		22	30	99	87	81	76	64	53	44	27	
QF150-7		9000022360		26	35	115	102	95	89	75	61	51	32	
QF150-8		9000022361		30	40	131	116	108	102	86	70	58	36	
QF150-9		9000022362		37	50	149	131	122	114	96	79	65	41	
QF150-10		9000022363		37	50	163	145	135	127	107	88	73	45	
QF150-11			9000022353		45	60	182	160	152	140	118	96	80	50
QF150-12			9000022364		45	60	197	174	166	152	128	105	87	54
QF150-13			9000022365		52	70	215	191	180	165	139	114	94	59
QF150-14			9000022366		52	70	228	204	194	178	150	123	102	63
QF150-15			9000022367		55	75	244	220	207	191	161	131	109	68
QF150-16			9000022368		60	80	260	233	221	203	171	140	116	72

PERFORMANCE CURVE



SUBMERSIBLE PUMP QF 125

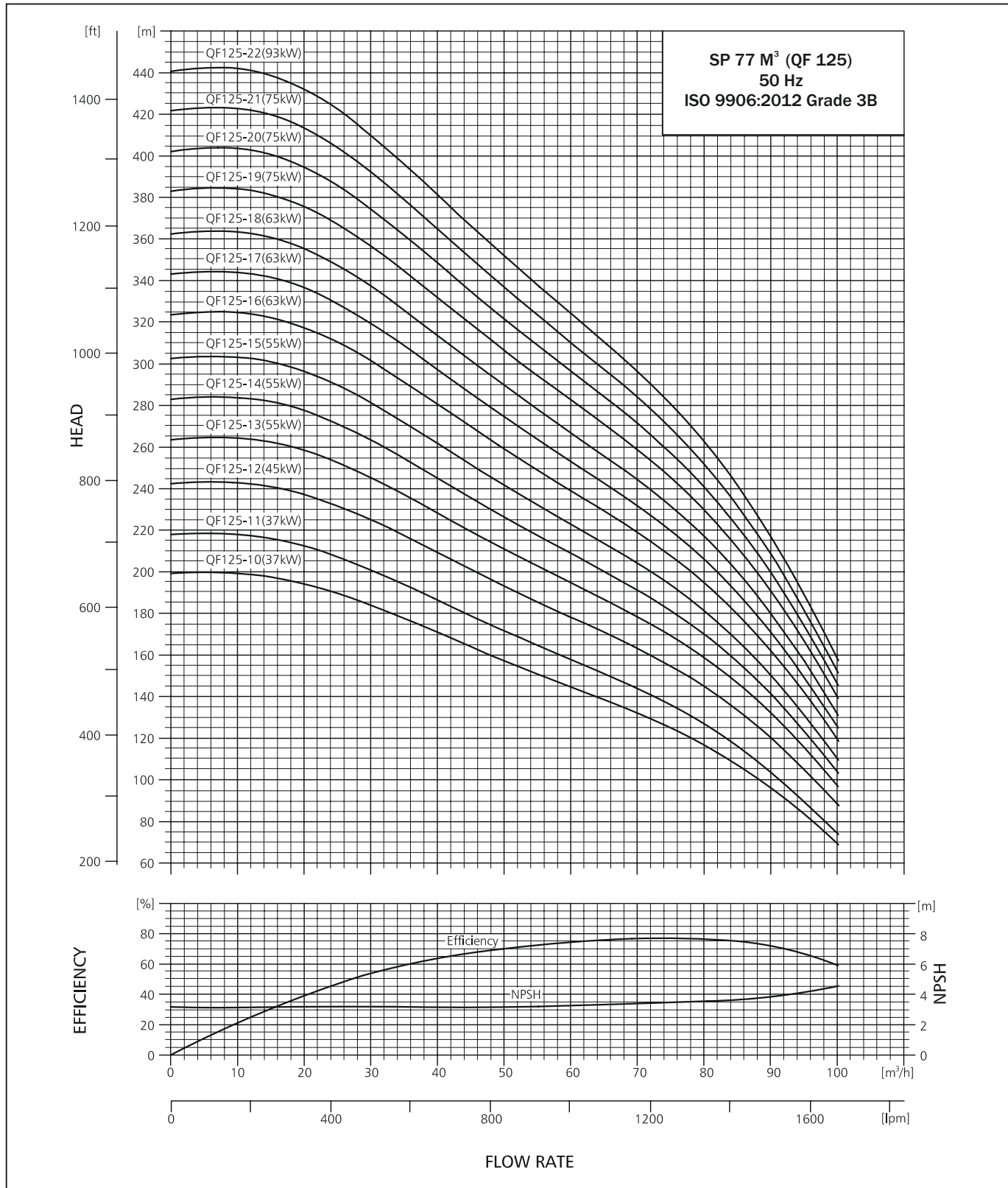

PERFORMANCE CURVE



SUBMERSIBLE PUMP QF 125

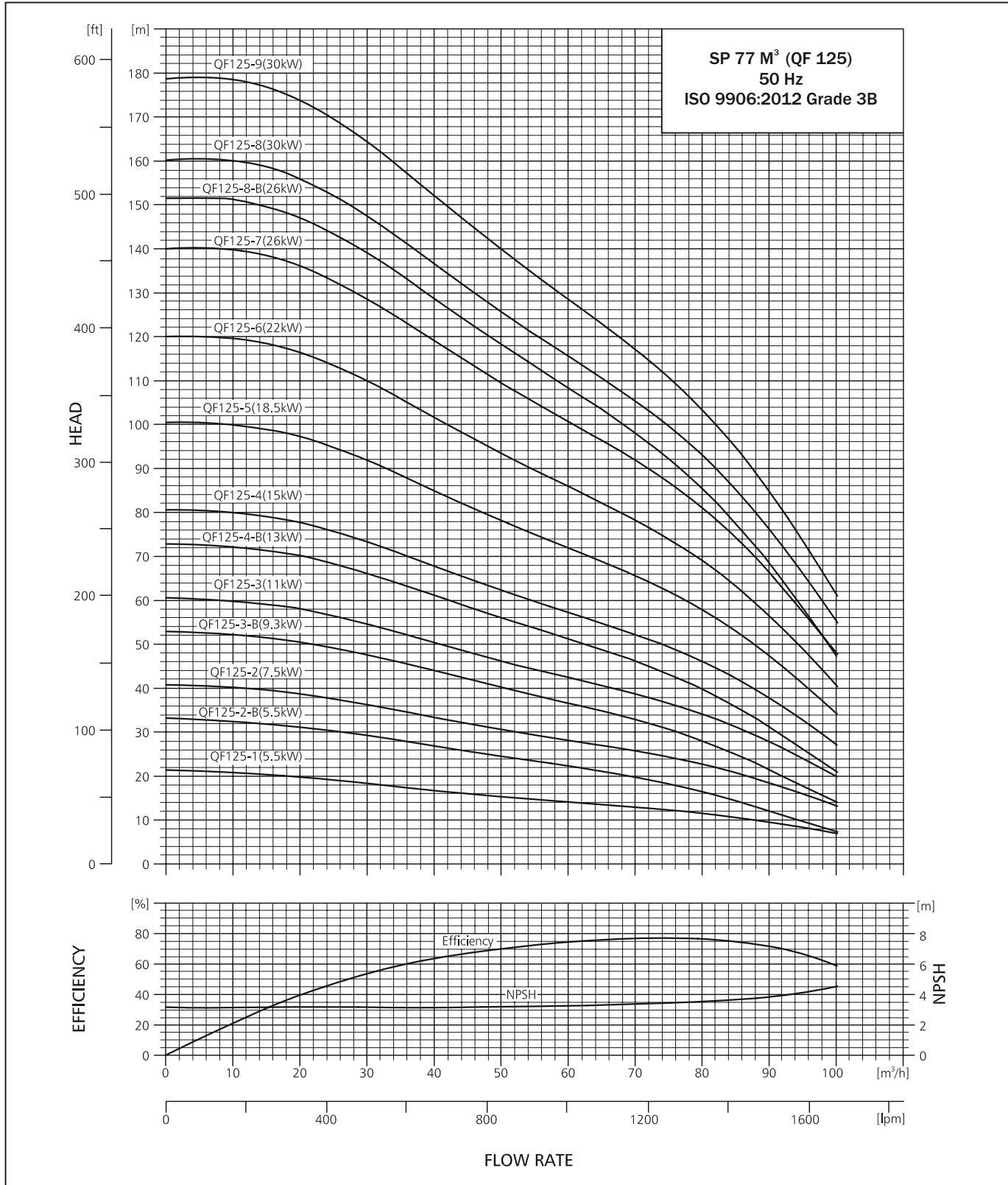

TECHNICAL DATA



SUBMERSIBLE PUMP QF 125

DIMENSIONS AND WEIGHTS

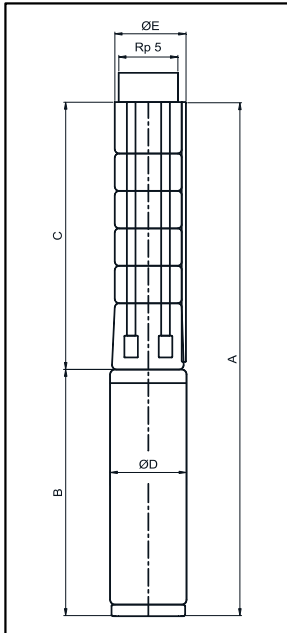

E = Maximum diameter of pump inclusive of cable guard & motor.

TECHNICAL DATA QF 125

PUMP TYPE	MOTOR		DIMENSIONS (mm)										NET WEIGHT (kg)	
	TYPE	POWER (kW)	Rp 5" CONNECTION				Rp 5" FLANGE				B	D	PUMP	MOTOR
			A	C	E*	E**	A	C	E*	E**				
QF125-1	MATASF 150	5.5	1319	620	168	172	1319	620	270	270	699	145	20.8	51
QF125-2-B	MATASF 150	5.5	1447	748	168	172	1447	748	270	270	699	145	24.4	51
QF125-2	MATASF 150	7.5	1467	748	168	172	1467	748	270	270	719	145	24.4	54
QF125-3-B	MATASF 150	9.3	1625	876	168	172	1625	876	270	270	749	145	28.0	57
QF125-3	MATASF 150	11	1655	876	168	172	1655	876	270	270	779	145	28.0	59
QF125-4-B	MATASF 150	13	1833	1004	168	172	1833	1004	270	270	829	145	31.6	64
QF125-4	MATASF 150	15	1878	1004	168	172	1878	1004	270	270	874	145	31.6	70
QF125-5	MATASF 150	18.5	2051	1132	168	172	2051	1132	270	270	919	145	35.2	73
QF125-6	MATASF 150	22	2269	1260	168	172	2269	1260	270	270	1009	145	38.8	82
QF125-7	MATASF 150	26	2502	1388	168	172	2502	1388	270	270	1114	145	42.4	98
QF125-8-B	MATASF 150	26	2630	1516	168	172	2630	1516	270	270	1114	145	46.0	98
QF125-8	MATASF 150	30	2730	1516	168	172	2730	1516	270	270	1214	145	46.0	107
QF125-9	MATASF 150	30	2858	1644	168	172	2858	1644	270	270	1214	145	49.6	107
QF125-8	MATASF 200	30	2670	1530	194	194	2670	1530	270	270	1140	194	49.8	164
QF125-9	MATASF 200	30	2798	1658	194	194	2798	1658	270	270	1140	194	53.4	164
QF125-10	MATASF 200	37	2926	1786	194	194	2926	1786	270	270	1140	194	57.0	164
QF125-11	MATASF 200	37	3054	1914	194	194	3054	1914	270	270	1140	194	60.6	164
QF125-12	MATASF 200	45	3272	2042	194	194	3272	2042	270	270	1230	194	64.2	189
QF125-13	MATASF 200	55	3510	2170	194	194	3510	2170	270	270	1340	194	67.8	203
QF125-14	MATASF 200	55	3638	2298	194	194	3638	2298	270	270	1340	194	71.8	203
QF125-15	MATASF 200	55	3766	2426	194	194	3766	2426	270	270	1340	194	75.0	203
QF125-16	MATASF 200	63	4024	2554	194	194	4024	2554	270	270	1470	194	78.6	245
QF125-17	MATASF 200	63	4152	2682	194	194	4152	2682	270	270	1470	194	82.2	245
QF125-18	MATASF 200	63	4280	2810	194	194	4280	2810	270	270	1470	194	85.8	245
QF125-19	MATASF 200	75	4498	2938	194	194	4498	2938	270	270	1560	194	89.4	245
QF125-20	MATASF 200	75	4626	3066	194	194	4626	3066	270	270	1560	194	93.0	245
QF125-21	MATASF 200	75	4754	3194	194	194	4754	3194	270	270	1560	194	96.6	245
QF125-22	MATASF 200	93	5062	3322	194	194	5062	3322	270	270	1740	194	99.0	292

* Maximum diameter of pump with one motor cable.

** Maximum diameter of pump with two motor cable.

Motor type may change as per requirement.

Other type of connection is possible by means of connecting pieces. See page no. 113.

SUBMERSIBLE PUMP QF 125

PERFORMANCE TABLE QF 125

QF-125			DISCHARGE (Q)												
			m ³ /h	0	10	20	30	40	50	60	70	80	90	100	
			l/min.	0	166.7	333.3	500	666.7	833.3	1000	1166.7	1333.3	1500	1666.7	
MODEL	MATERIAL CODE		MOTOR RATING		TOTAL HEAD IN (m)										
	6x8	8x8	[kW]	[HP]											
QF 125 - 1	9000003280	-	5.5	7.5	21	21	20	18	17	15	14	13	12	10	7
QF 125 - 2-B	9000003301	-	5.5	7.5	33	32	31	29	27	25	22	20	16	12	7
QF 125 - 2	9000003296	-	7.5	10	41	40	39	36	33	31	28	26	23	18	13
QF 125 - 3-B	9000003307	-	9.3	12.5	53	52	51	48	44	40	37	33	28	22	14
QF 125 - 3	9000003304	-	11	15	61	60	58	55	50	46	42	39	34	28	20
QF 125 - 4-B	9000003310	-	13	17.5	73	72	70	66	61	56	51	46	40	31	21
QF 125 - 4	9000003308	-	15	20	81	80	78	73	68	62	57	52	46	38	27
QF 125 - 5	9000003311	-	18.5	25	100	100	97	92	85	78	72	66	58	47	34
QF 125 - 6	9000003313	-	22	30	120	120	116	110	102	94	86	78	69	56	41
QF 125 - 7	9000003316	-	26	35	140	140	136	129	119	110	101	92	81	66	48
QF 125 - 8-B	9000003321	-	26	35	152	151	147	139	129	118	108	98	85	68	48
QF 125 - 8	9000003319	9000003320	30	40	160	160	156	147	137	126	116	105	93	76	55
QF 125 - 9	9000003322	9000003323	30	40	179	179	174	164	152	140	129	117	103	85	61
QF 125 - 10	9000008136	9000003282	37	50	199	199	194	184	171	157	145	132	117	96	69
QF 125 - 11	9000003284	9000003285	37	50	218	218	212	201	186	172	158	144	127	104	74
QF 125 - 12	-	9000003287	45	60	242	243	237	225	209	193	178	163	145	120	88
QF 125 - 13	-	9000003289	55	75	264	264	258	245	228	211	195	178	159	132	98
QF 125 - 14	-	9000003290	55	75	283	284	277	263	245	226	209	191	170	141	104
QF 125 - 15	-	9000003291	55	75	303	303	296	281	262	242	223	204	181	150	110
QF 125 - 16	-	9000003292	63	85	324	325	317	301	281	259	239	219	195	162	119
QF 125 - 17	-	9000003293	63	85	343	344	336	319	297	274	253	232	206	171	126
QF 125 - 18	-	9000003294	63	85	363	363	355	337	314	290	267	244	217	180	132
QF 125 - 19	-	9000003295	75	100	383	384	376	357	332	307	283	259	230	191	140
QF 125 - 20	-	9000003297	75	100	402	404	395	375	349	322	297	271	241	200	146
QF 125 - 21	-	9000003298	75	100	422	424	415	394	366	338	312	285	253	210	153
QF 125 - 22	-	9000003299	93	125	442	444	435	413	384	354	327	298	265	220	161

PERFORMANCE CURVE



SUBMERSIBLE PUMP QF 125

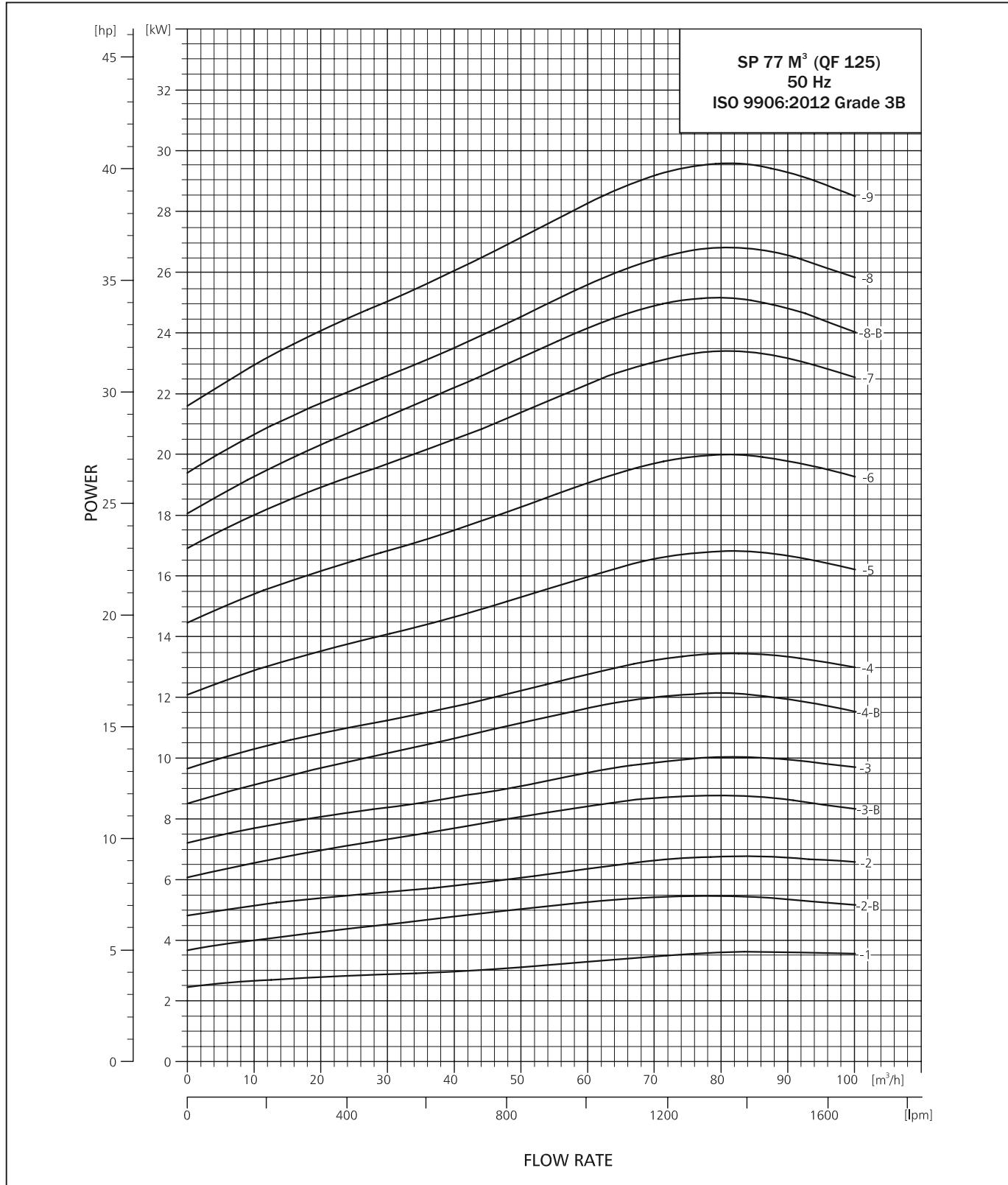

PERFORMANCE CURVE



SUBMERSIBLE PUMP QF 125

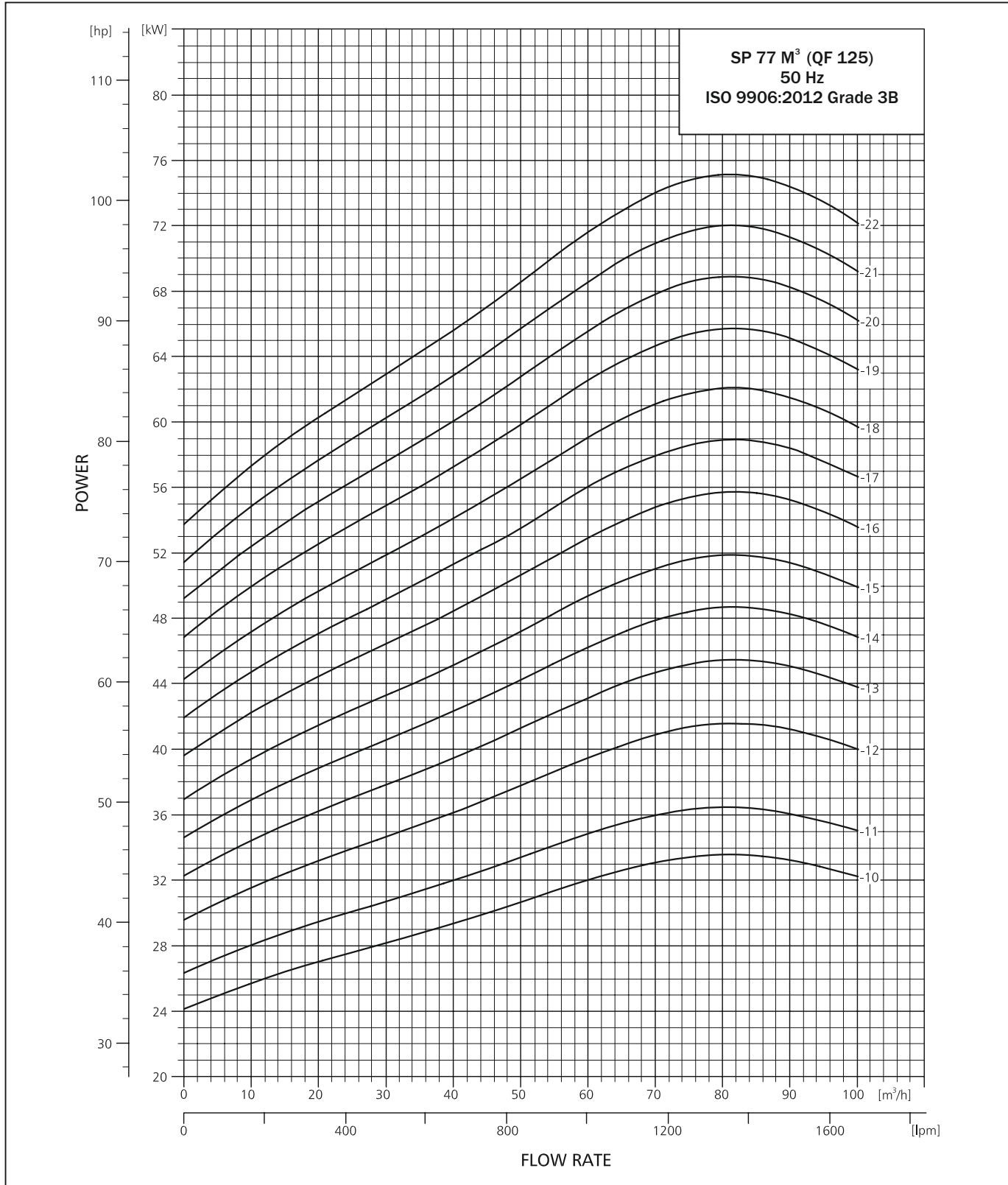

PERFORMANCE CURVE



SUBMERSIBLE PUMP QF 160

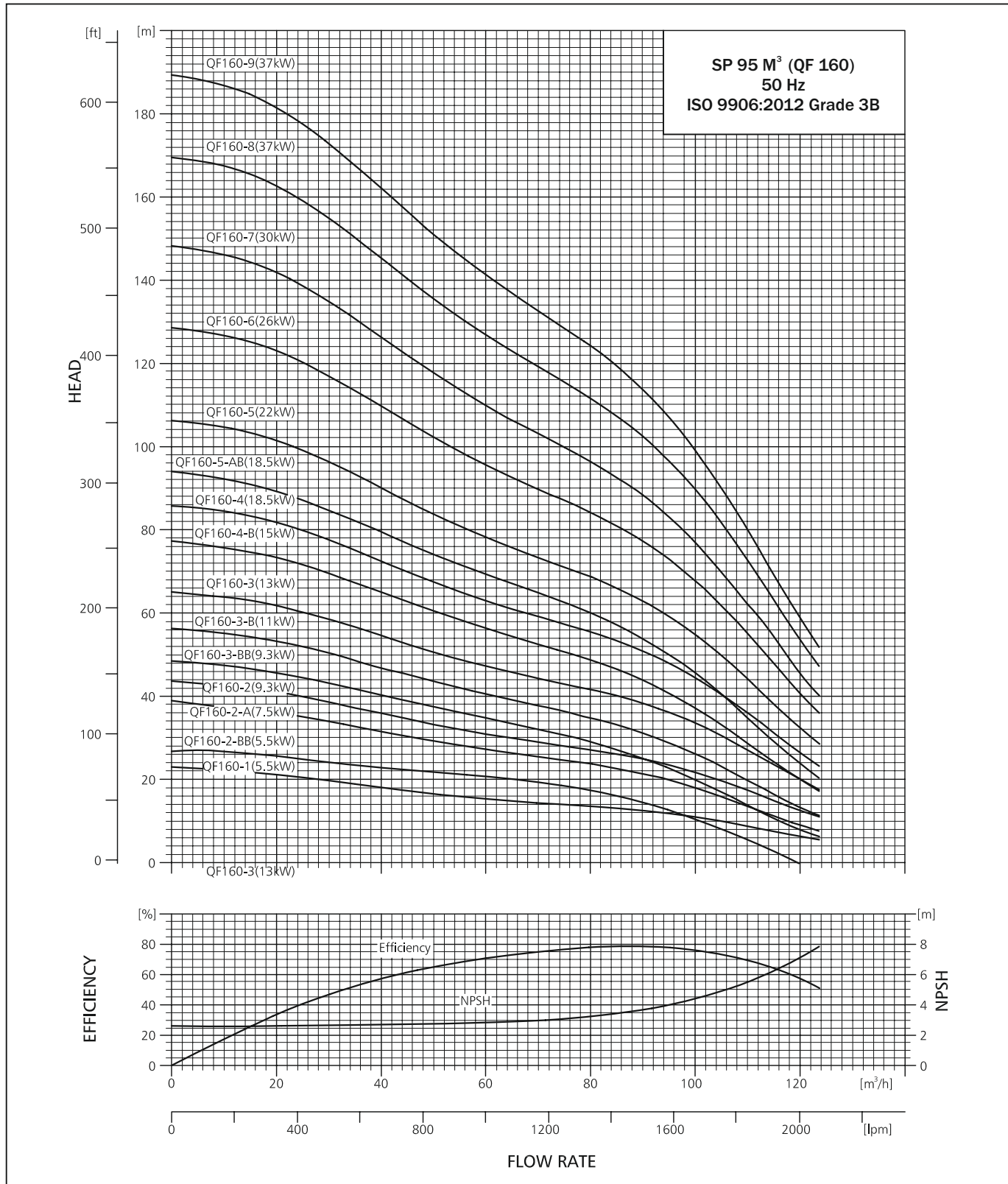

PERFORMANCE CURVE



SUBMERSIBLE PUMP QF 160

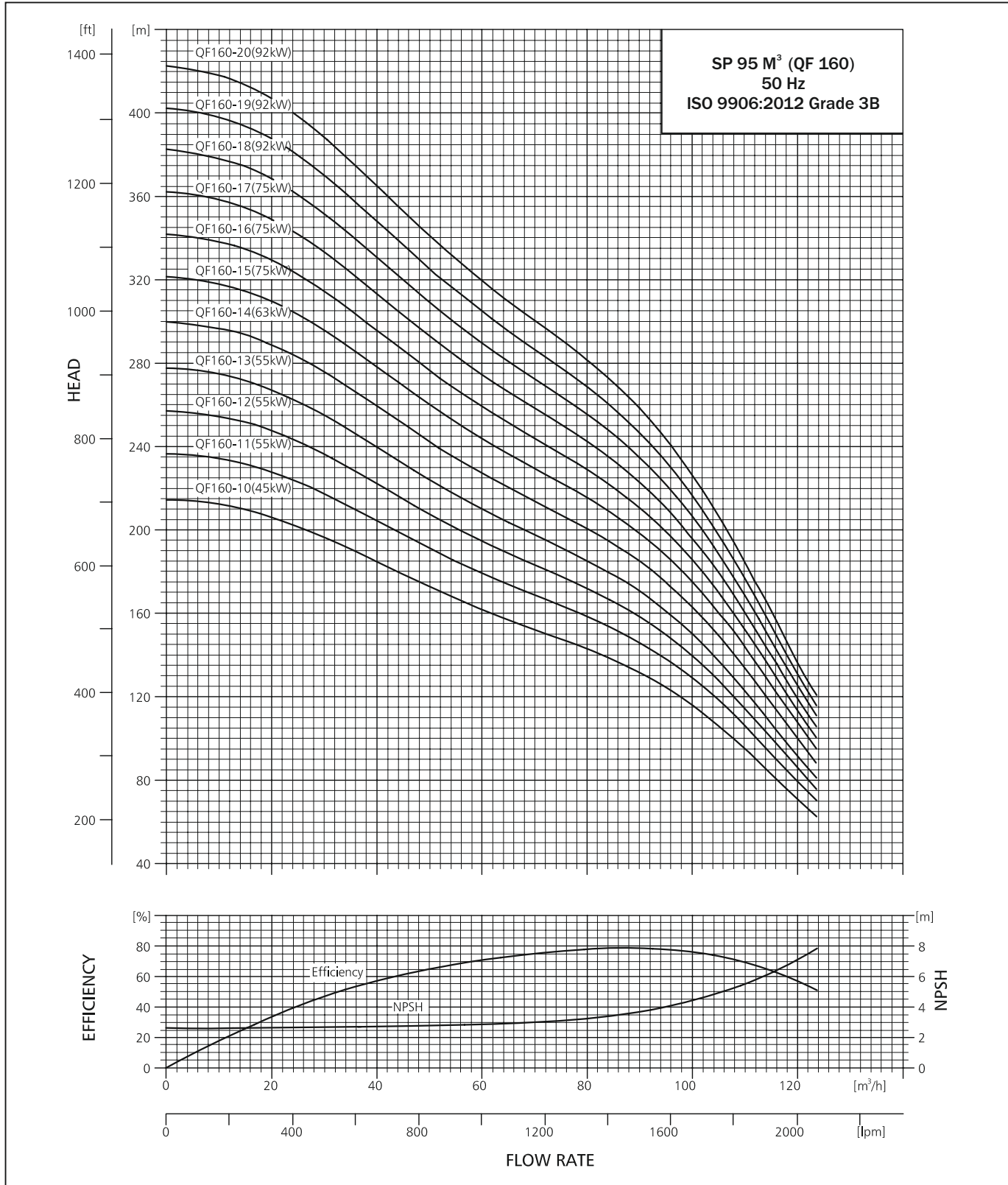

TECHNICAL DATA



SUBMERSIBLE PUMP QF 160

DIMENSIONS AND WEIGHTS

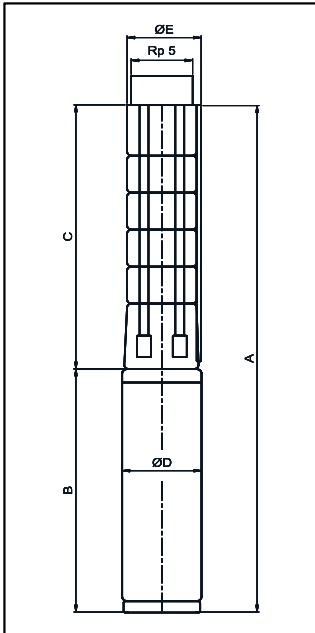

TECHNICAL DATA QF 160

PUMP TYPE	MOTOR		DIMENSIONS (mm)										NET WEIGHT (kg)	
	TYPE	POWER (kW)	Rp 5" CONNECTION				Rp 5" FLANGE				B	D	PUMP	MOTOR
			A	C	E*	E**	A	C	E*	E**				
QF160-1	MATASF 150	5.5	1319	620	168	172	1319	620	270	270	699	145	20.8	51
QF160-2-BB	MATASF 150	5.5	1447	748	168	172	1447	748	270	270	699	145	24.4	51
QF160-2-A	MATASF 150	7.5	1467	748	168	172	1467	748	270	270	719	145	24.4	54
QF160-2	MATASF 150	9.3	1497	748	168	172	1497	748	270	270	749	145	24.4	57
QF160-3-BB	MATASF 150	9.3	1625	876	168	172	1625	876	270	270	749	145	28.0	57
QF160-3-B	MATASF 150	11.0	1655	876	168	172	1655	876	270	270	779	145	28.0	59
QF160-3	MATASF 150	13.0	1705	876	168	172	1705	876	270	270	829	145	28.0	64
QF160-4-B	MATASF 150	15.0	1878	1004	168	172	1878	1004	270	270	874	145	31.6	70
QF160-4	MATASF 150	18.5	1923	1004	168	172	1923	1004	270	270	919	145	31.6	73
QF160-5-AB	MATASF 150	18.5	2051	1132	168	172	2051	1132	270	270	919	145	35.2	73
QF160-5	MATASF 150	22.0	2141	1132	168	172	2141	1132	270	270	1009	145	35.2	82
QF160-6	MATASF 150	26.0	2374	1260	168	172	2374	1260	270	270	1114	145	38.8	98
QF160-7	MATASF 150	30.0	2602	1388	168	172	2602	1388	270	270	1214	145	42.4	107
QF160-7	MATASF 200	30.0	2542	1402	194	194	2542	1402	270	270	1140	194	46.2	164
QF160-8	MATASF 200	37.0	2670	1530	194	194	2670	1530	270	270	1140	194	49.8	164
QF160-9	MATASF 200	37.0	2798	1658	194	194	2798	1658	270	270	1140	194	53.4	164
QF160-10	MATASF 200	45.0	3016	1786	194	194	3016	1786	270	270	1230	194	57.0	189
QF160-11	MATASF 200	55.0	3254	1914	194	194	3254	1914	270	270	1340	194	60.6	203
QF160-12	MATASF 200	55.0	3382	2042	194	194	3382	2042	270	270	1340	194	64.2	203
QF160-13	MATASF 200	55.0	3510	2170	194	194	3510	2170	270	270	1340	194	67.8	203
QF160-14	MATASF 200	63.0	3768	2298	194	194	3768	2298	270	270	1470	194	71.4	245
QF160-15	MATASF 200	75.0	3986	2426	194	194	3986	2426	270	270	1560	194	75.0	245
QF160-16	MATASF 200	75.0	4114	2554	194	194	4114	2554	270	270	1560	194	78.6	245
QF160-17	MATASF 200	75.0	4242	2682	194	194	4242	2682	270	270	1560	194	82.2	245
QF160-18	MATASF 200	93.0	4550	2810	194	194	4550	2810	270	270	1740	194	85.8	292
QF160-19	MATASF 200	93.0	4678	2938	194	194	4678	2938	270	270	1740	194	89.4	292
QF160-20	MATASF 200	93.0	4806	3066	194	194	4806	3066	270	270	1740	194	93.0	292

* Maximum diameter of pump with one motor cable.
 ** Maximum diameter of pump with two motor cable.
 Motor type may change as per requirement.

SUBMERSIBLE PUMP QF 160

PERFORMANCE TABLE QF 160

QF-160			DISCHARGE (Q)															
			m ³ /h		0	10	20	30	40	50	60	70	80	90	100	110	120	122
			l/min.		0	167	333	500	667	833	1000	1167	1333	1500	1667	1833	2000	2033
MODEL	MATERIAL CODE		MOTOR RATING		TOTAL HEAD IN (m)													
	6x8	8x8	[kW]	[HP]														
QF 160 - 1	9000003326	-	5.5	7.5	23	22	21	20	18	17	15	14	13	13	11	9	6	6
QF 160 - 2-BB	9000003353	-	5.5	7.5	27	27	26	24	23	22	21	19	17	14	10	5	0	-
QF 160 - 2-A	9000003347	-	7.5	10	39	38	36	34	32	29	27	26	24	21	18	14	9	8
QF 160 - 2	9000003345	-	9.3	12.5	44	43	41	39	36	33	31	29	27	25	22	17	13	12
QF 160 - 3-BB	9000003358	-	9.3	12.5	49	47	46	43	40	37	35	32	29	25	20	14	8	7
QF 160 - 3-B	9000003357	-	11	15	56	55	53	50	47	44	41	38	35	31	26	20	13	12
QF 160 - 3	9000003355	-	13	17.5	65	64	62	58	55	51	47	44	42	38	33	27	20	19
QF 160 - 4-B	9000003363	-	15	20	77	76	73	70	65	60	56	53	49	44	37	29	20	18
QF 160 - 4	9000003360	-	18.5	25	86	84	82	78	73	67	63	59	55	51	44	36	26	25
QF 160 - 5-AB	9000003368	-	18.5	25	94	92	89	85	79	74	69	65	60	54	45	35	24	22
QF 160 - 5	9000003365	-	22	30	106	105	101	96	90	84	78	73	69	63	55	44	32	30
QF 160 - 6	9000003372	-	26	35	129	127	123	117	110	102	96	90	84	77	68	55	41	38
QF 160 - 7	9000003377	-	30	40	148	146	142	135	126	118	110	103	96	88	77	62	46	43
QF 160 - 8	9000003380	9000003382	37	50	170	167	163	155	145	136	127	119	112	102	90	73	54	50
QF 160 - 9	9000011943	9000003384	37	50	189	187	182	173	162	151	141	133	124	114	99	80	59	55
QF 160 - 10	-	9000003328	45	60	214	212	206	197	185	173	162	152	143	132	116	95	71	66
QF 160 - 11	-	9000003330	55	75	237	234	228	217	205	191	179	169	158	146	129	106	79	74
QF 160 - 12	-	9000003332	55	75	257	254	248	236	222	208	195	183	172	158	140	115	86	80
QF 160 - 13	-	9000003334	55	75	278	275	267	255	240	224	210	198	185	170	150	123	92	86
QF 160 - 14	-	9000003335	63	85	300	297	289	276	259	243	227	214	201	185	163	134	100	93
QF 160 - 15	-	9000003336	75	100	321	318	310	296	278	260	244	230	215	198	175	144	107	100
QF 160 - 16	-	9000003337	75	100	342	338	329	314	296	277	259	244	229	211	186	152	114	106
QF 160 - 17	-	9000003338	75	100	362	358	349	333	313	293	275	258	242	223	196	160	120	112
QF 160 - 18	-	9000003339	93	125	382	378	368	352	331	309	290	272	255	235	206	169	125	117
QF 160 - 19	-	9000003340	93	125	402	398	388	370	348	325	305	287	269	247	216	177	131	122
QF 160 - 20	-	9000003346	93	125	423	418	407	388	365	341	320	301	281	258	226	184	137	128

PERFORMANCE CURVE

SUBMERSIBLE PUMP QF 160

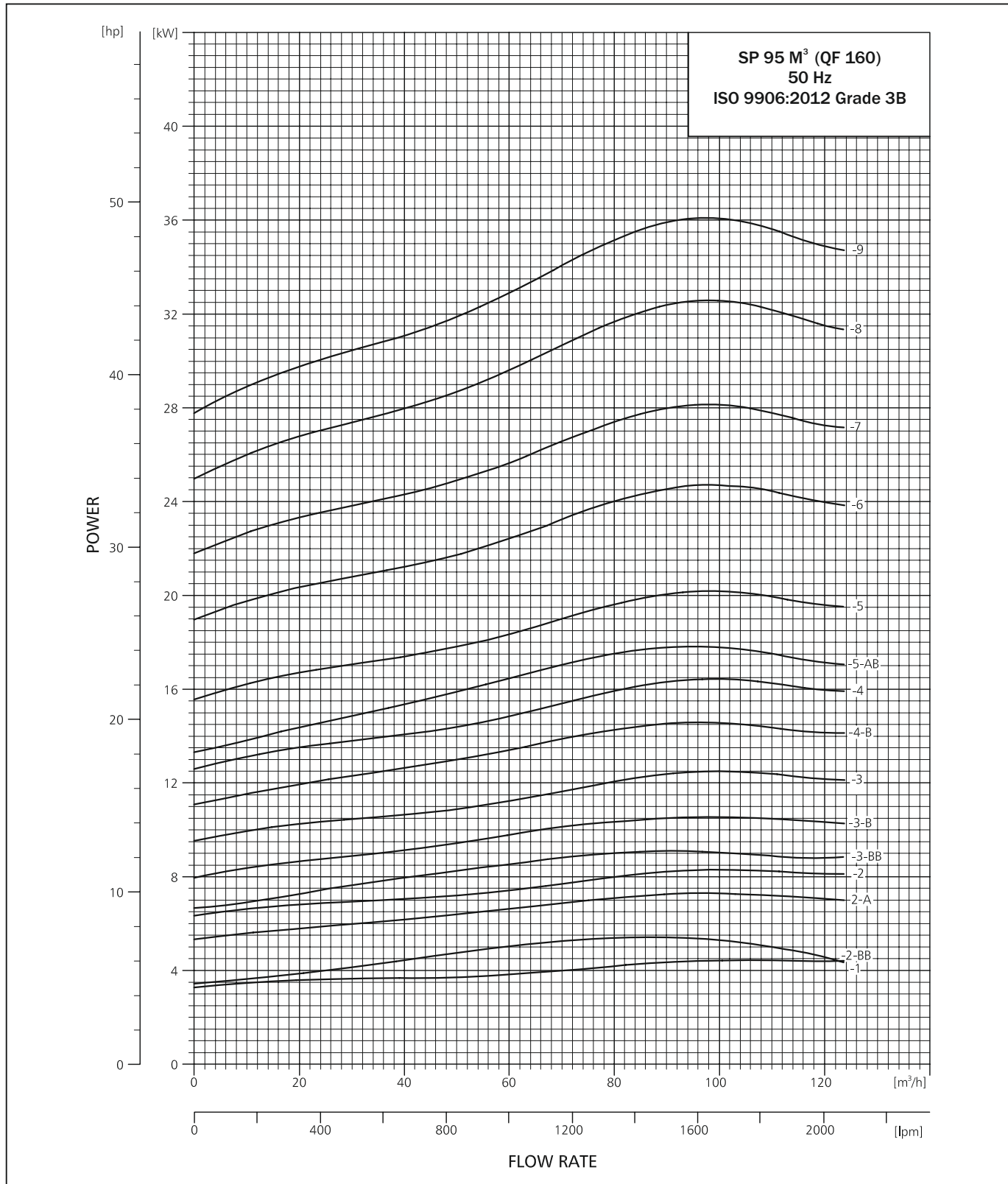

PERFORMANCE CURVE

SUBMERSIBLE PUMP QF 160

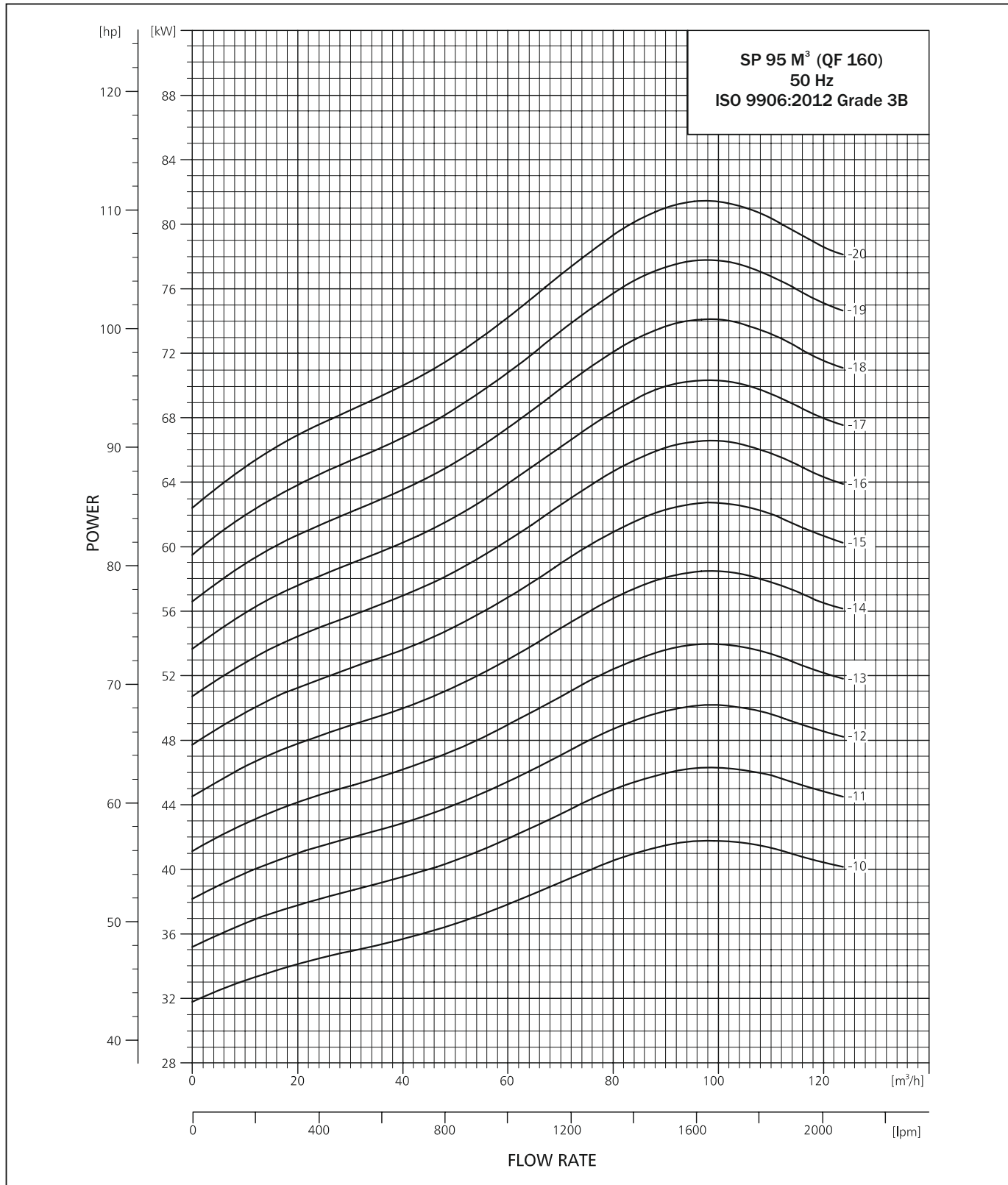

PERFORMANCE CURVE



SUBMERSIBLE PUMP QF 210

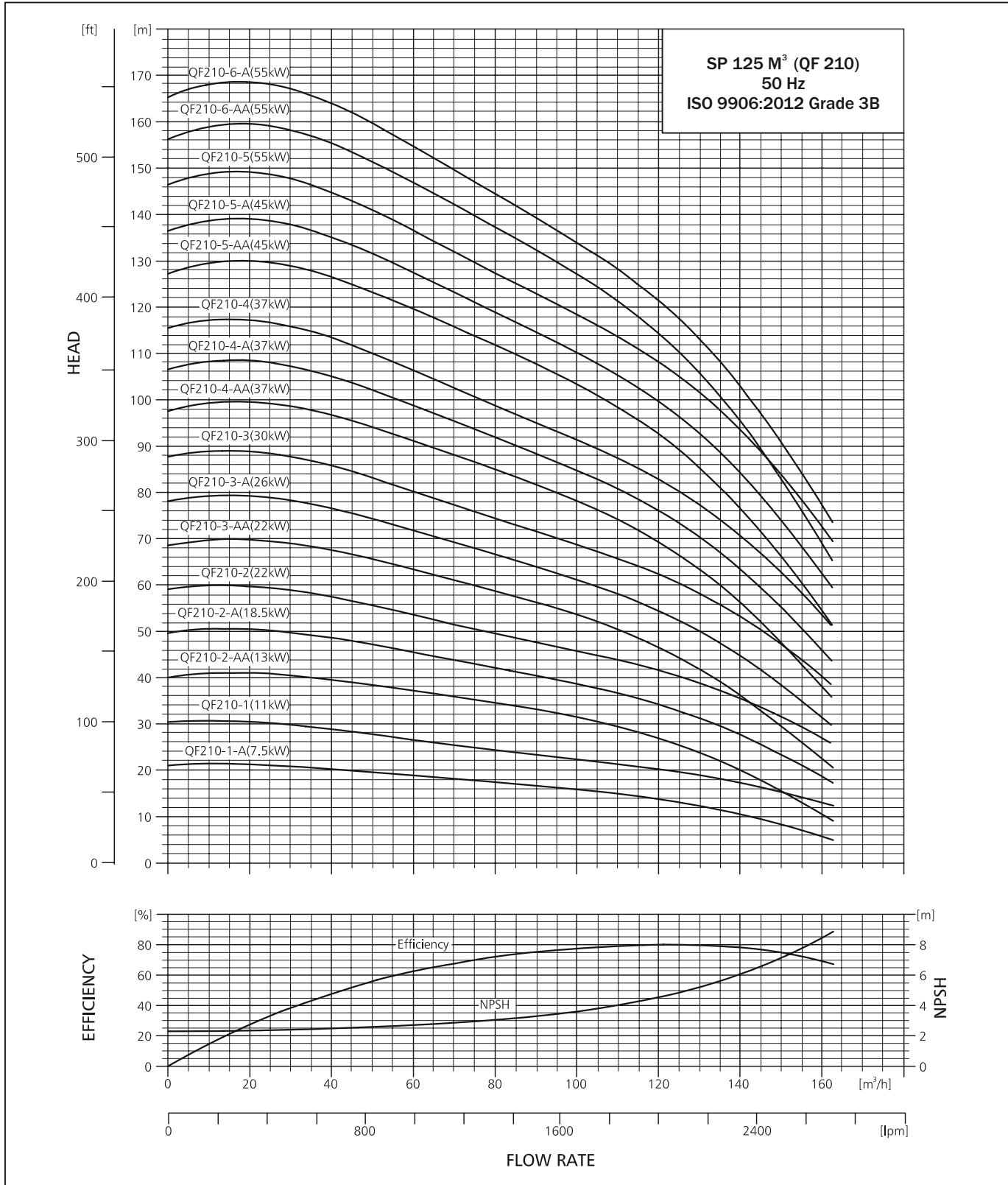

PERFORMANCE CURVE



SUBMERSIBLE PUMP QF 210

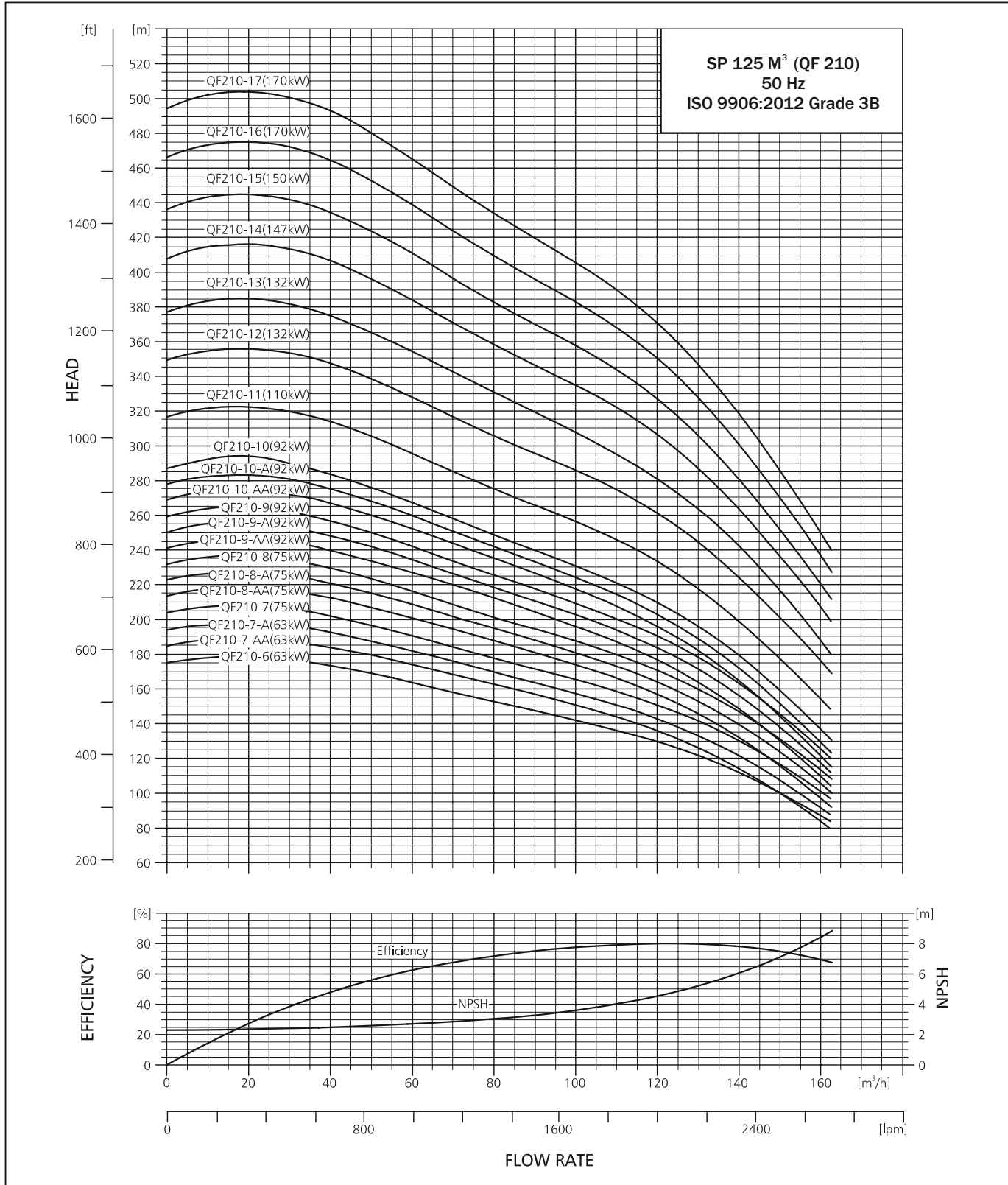

SUBMERSIBLE PUMP QF 210

DIMENSIONS AND WEIGHTS

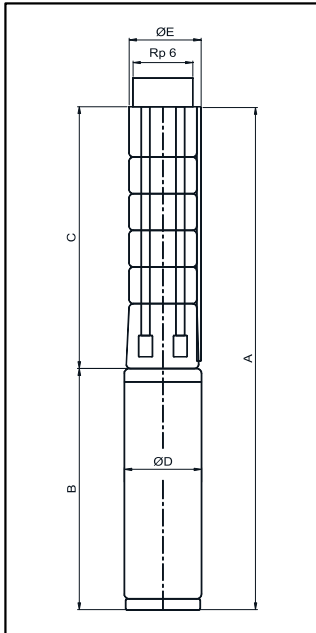

TECHNICAL DATA QF 210

PUMP TYPE	MOTOR		DIMENSIONS (mm)										NET WEIGHT (kg)	
	TYPE	POWER (kW)	Rp 6" CONNECTION				Rp 6" FLANGE				B	D	PUMP	MOTOR
			A	C	E*	E**	A	C	E*	E**				
QF210-1-A	MATASF 150	7.5	1360	641	203	206	1360	641	287	287	719	145	27	54
QF210-1	MATASF 150	11	1420	641	203	206	1420	641	287	287	779	145	27	59
QF210-2-AA	MATASF 150	13	1626	797	203	206	1626	797	287	287	829	145	33	64
QF210-2-A	MATASF 150	18.5	1716	797	203	206	1716	797	287	287	919	145	33	73
QF210-2	MATASF 150	22	1806	797	203	206	1806	797	287	287	1009	145	33	82
QF210-3-AA	MATASF 150	22	1962	953	203	206	1962	953	287	287	1009	145	39	82
QF210-3-A	MATASF 150	26	2067	953	203	206	2067	953	287	287	1114	145	39	98
QF210-3	MATASF 150	30	2167	953	203	206	2167	953	287	287	1214	145	39	107
QF210-3	MATASF 200	30	2093	953	205	208	2093	953	287	287	1140	194	39	164
QF210-4-AA	MATASF 200	37	2249	1109	205	208	2249	1109	287	287	1140	194	45	164
QF210-4-A	MATASF 200	37	2249	1109	205	208	2249	1109	287	287	1140	194	45	164
QF210-4	MATASF 200	37	2249	1109	205	208	2249	1109	287	287	1140	194	45	164
QF210-5-AA	MATASF 200	45	2495	1265	205	208	2495	1265	287	287	1230	194	51	189
QF210-5-A	MATASF 200	45	2495	1265	205	208	2495	1265	287	287	1230	194	51	189
QF210-5	MATASF 200	55	2605	1265	205	208	2605	1265	287	287	1340	194	51	203
QF210-6-AA	MATASF 200	55	2761	1421	205	208	2761	1421	287	287	1340	194	57	203
QF210-6-A	MATASF 200	55	2761	1421	205	208	2761	1421	287	287	1340	194	57	203
QF210-6	MATASF 200	63	2891	1421	205	208	2891	1421	287	287	1470	194	57	245
QF210-7-AA	MATASF 200	63	3047	1577	205	208	3047	1577	287	287	1470	194	63	245
QF210-7-A	MATASF 200	63	3047	1577	205	208	3047	1577	287	287	1470	194	63	245
QF210-7	MATASF 200	75	3137	1577	205	208	3137	1577	287	287	1560	194	63	245
QF210-8-AA	MATASF 200	75	3293	1733	205	208	3293	1733	287	287	1560	194	69	245
QF210-8-A	MATASF 200	75	3293	1733	205	208	3293	1733	287	287	1560	194	69	245
QF210-8	MATASF 200	75	3293	1733	205	208	3293	1733	287	287	1560	194	69	245
QF210-9-AA	MATASF 200	93	3629	1889	205	208	3629	1889	287	287	1740	194	75	292
QF210-9-A	MATASF 200	93	3629	1889	205	208	3629	1889	287	287	1740	194	75	292
QF210-9	MATASF 200	93	3629	1889	205	208	3629	1889	287	287	1740	194	75	292
QF210-10-AA	MATASF 200	93	3785	2045	205	208	3785	2045	287	287	1740	194	81	292
QF210-10-A	MATASF 200	93	3785	2045	205	208	3785	2045	287	287	1740	194	81	292
QF210-10	MATASF 200	93	3785	2045	205	208	3785	2045	287	287	1740	194	81	292
QF210-11	MATASF 10"	110	3731	2201	235	235	3731	2201	287	287	1530	235	88.5	315
QF210-12	MATASF 10"	130	4017	2357	235	235	4017	2357	287	287	1660	235	94.5	362
QF210-13	MATASF 10"	130	4173	2513	235	235	4173	2513	287	287	1660	235	100.5	362
QF210-14	MATASF 10"	150	4439	2669	235	235	4439	2669	287	287	1770	235	106.5	413
QF210-15	MATASF 10"	150	4595	2825	235	235	4595	2825	287	287	1770	235	112.5	413
QF210-16	MATASF 10"	170	4901	2981	235	235	4901	2981	287	287	1920	235	118.5	449
QF210-17	MATASF 10"	170	5057	3137	235	235	5057	3137	287	287	1920	235	124.5	449

* Maximum diameter of pump with one motor cable.
 ** Maximum diameter of pump with two motor cable.
 Motor type may change as per requirement.

SUBMERSIBLE PUMP QF 210

PERFORMANCE TABLE QF 210

QF-210				m ³ /h		DISCHARGE (Q)												
						0	60	70	80	90	100	110	120	130	140	150	160	162
				l/min.		0	1000	1167	1333	1500	1667	1833	2000	2167	2333	2500	2667	2700
MODEL	MATERIAL CODE			MOTOR RATING		TOTAL HEAD IN (m)												
	6x10	8x10	10x10	[kW]	[HP]													
QF210-1-A	9000003398	-	-	7.5	10	21	19	18	17	17	16	15	14	12	10	8	6	5
QF210-1	9000003386	-	-	11	15	30	27	25	24	23	22	21	20	19	17	15	13	12
QF210-2-AA	9000003406	-	-	13	17.5	40	37	36	35	33	31	29	27	24	20	16	11	10
QF210-2-A	9000003404	-	-	18.5	25	50	45	44	42	40	39	37	34	31	28	23	19	18
QF210-2	9000003402	-	-	22	30	59	54	52	50	48	46	44	42	39	35	32	27	26
QF210-3-AA	9000003415	-	-	22	30	69	63	61	59	56	54	50	47	42	36	30	22	21
QF210-3-A	9000003413	-	-	26	35	78	72	69	67	64	61	58	54	50	45	38	31	30
QF210-3	9000003409	9000003410	-	30	40	88	80	77	74	72	69	66	62	58	53	47	40	39
QF210-4-AA	9000003422	9000003424	-	37	50	98	91	88	85	82	78	74	69	63	56	48	38	36
QF210-4-A	9000011364	9000003421	-	37	50	107	99	95	92	88	85	81	76	70	63	55	46	44
QF210-4	9000003418	9000003419	-	37	50	116	106	102	99	95	91	87	83	77	71	63	54	52
QF210-5-AA	-	9000003429	-	45	60	127	120	116	112	108	103	98	93	85	77	66	54	52
QF210-5-A	-	9000003428	-	45	60	136	127	123	119	115	110	105	100	93	84	74	63	60
QF210-5	-	9000003426	-	55	75	146	137	132	127	123	118	114	108	102	93	84	72	70
QF210-6-AA	-	9000003436	-	55	75	156	147	142	137	132	127	121	114	106	95	83	69	66
QF210-6-A	-	9000003434	-	55	75	165	155	150	144	139	134	128	121	113	103	91	77	74
QF210-6	-	9000003432	-	63	85	175	164	158	153	147	142	136	130	122	112	100	87	84
QF210-7-AA	-	9000003442	-	63	85	185	174	168	163	157	151	144	136	126	114	100	83	80
QF210-7-A	-	9000003440	-	63	85	194	182	176	170	164	158	151	143	133	122	107	92	88
QF210-7	-	9000003438	-	75	100	204	191	184	178	172	165	159	151	142	130	117	101	97
QF210-8-AA	-	9000003447	-	75	100	214	201	194	188	181	174	166	157	146	132	116	97	93
QF210-8-A	-	9000003445	-	75	100	223	209	202	195	188	181	173	164	153	139	123	105	101
QF210-8	-	9000003443	-	75	100	232	216	209	202	195	188	180	171	160	147	131	113	109
QF210-9-AA	-	9000003451	-	93	125	241	227	219	212	204	196	187	177	164	149	130	110	105
QF210-9-A	-	9000003450	-	93	125	250	234	226	219	211	203	194	184	171	156	138	117	113
QF210-9	-	9000003449	-	93	125	260	242	234	226	218	209	201	191	178	163	146	125	121
QF210-10-AA	-	9000003389	-	93	125	269	252	244	235	227	218	208	196	182	165	144	121	117
QF210-10-A	-	9000003388	-	93	125	278	260	251	242	233	224	214	203	189	172	152	129	124
QF210-10	-	9000003387	-	93	125	287	267	258	249	240	231	221	210	196	179	159	137	132
QF210-11	-	-	9000013534	110	150	316	294	284	274	264	254	243	231	216	197	175	151	145
QF210-12	-	-	9000003391	132	177	345	321	310	299	288	277	265	252	236	215	191	165	158
QF210-13	-	-	9000010341	132	177	377	353	342	330	320	307	295	280	262	242	215	188	185
QF210-14	-	-	9000003393	150	204	406	380	368	355	345	331	318	302	282	261	232	202	199
QF210-15	-	-	9000003394	150	204	435	407	395	381	369	354	340	323	302	279	248	217	213
QF210-16	-	-	9000003395	170	230	464	434	421	406	394	378	363	345	322	298	265	231	228
QF210-17	-	-	9000003396	170	230	493	462	447	432	418	401	386	366	343	316	281	246	242

PERFORMANCE CURVE

SUBMERSIBLE PUMP QF 210

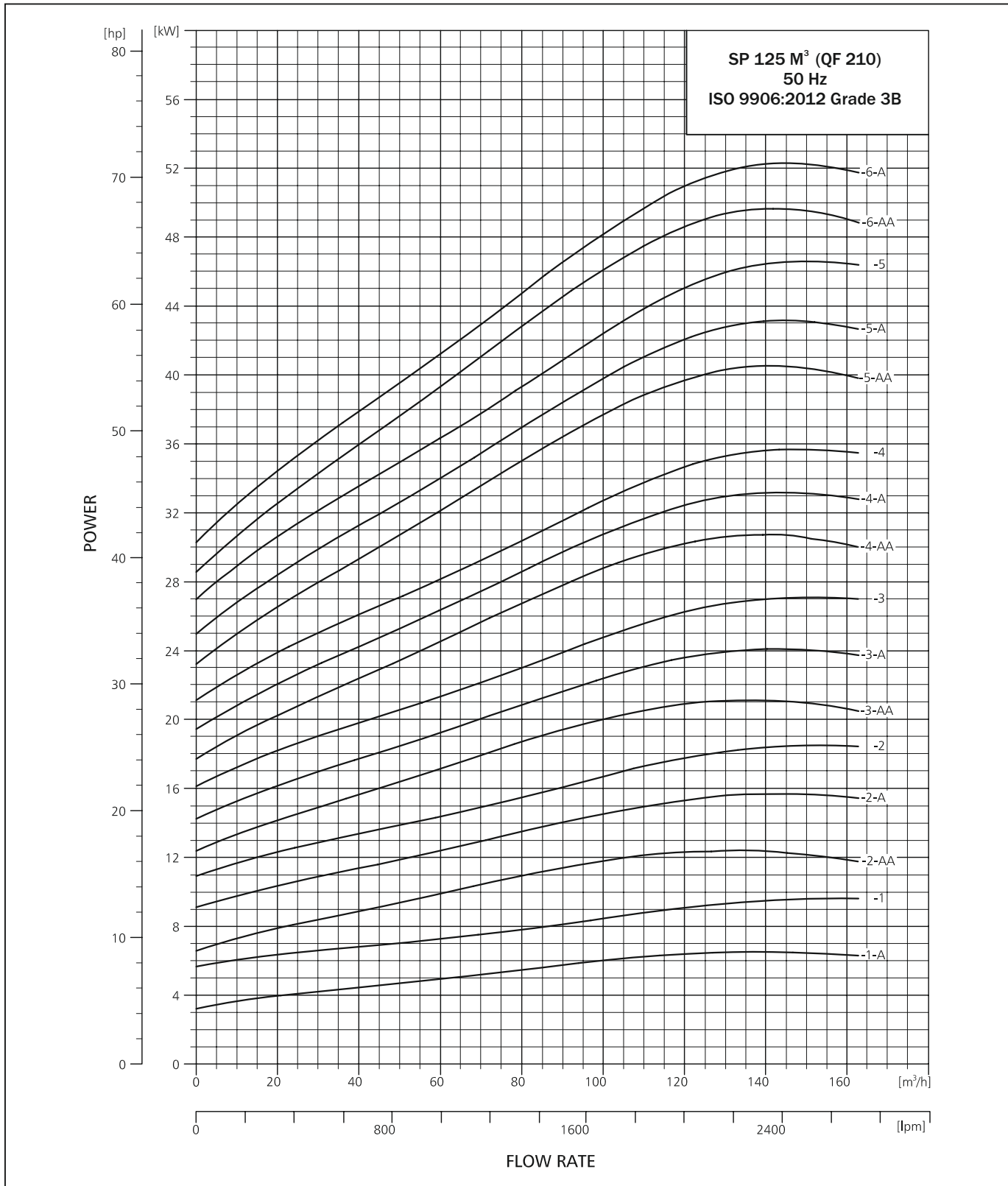

PERFORMANCE CURVE

SUBMERSIBLE PUMP QF 210

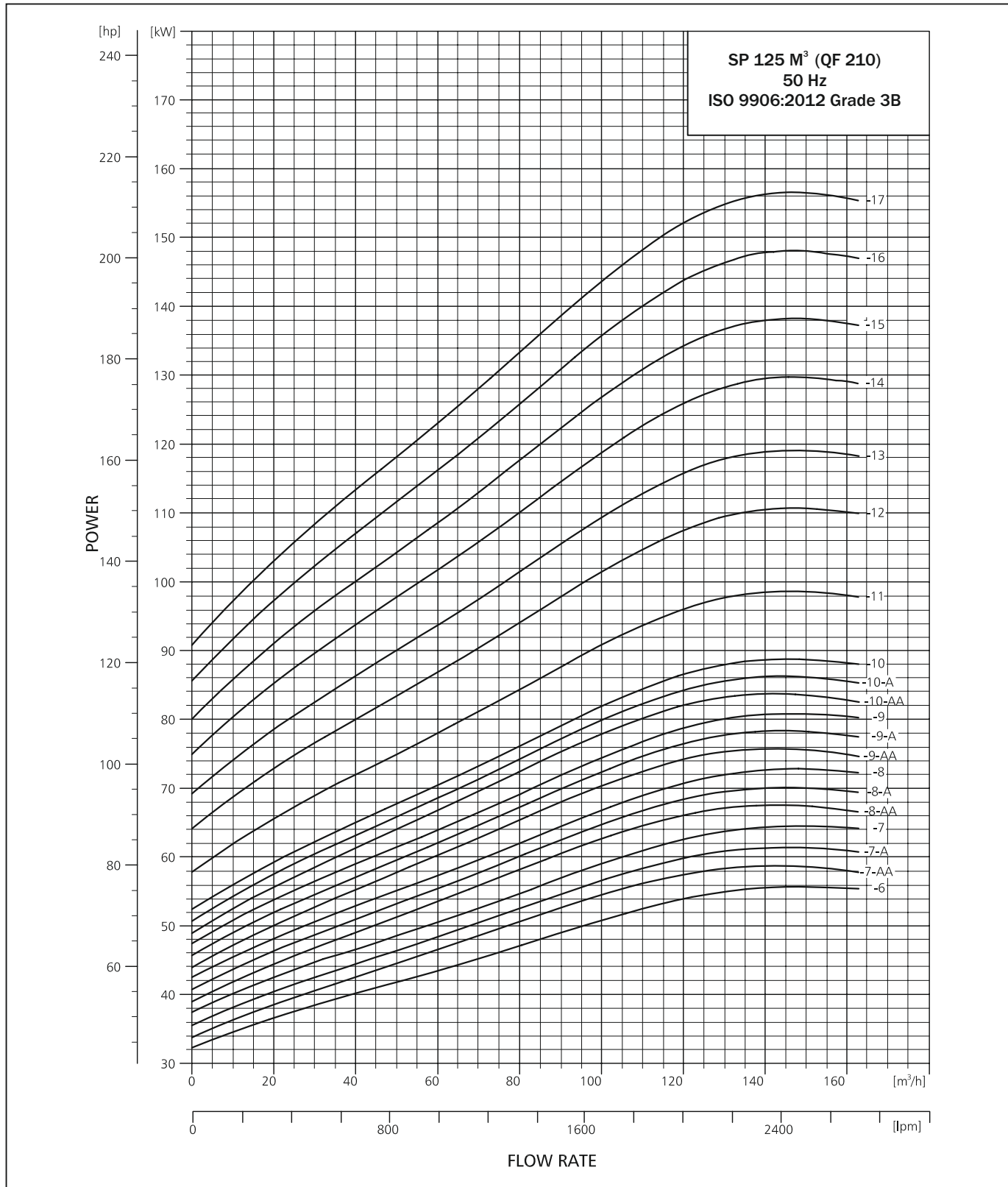

PERFORMANCE CURVE



SUBMERSIBLE PUMP QF 270

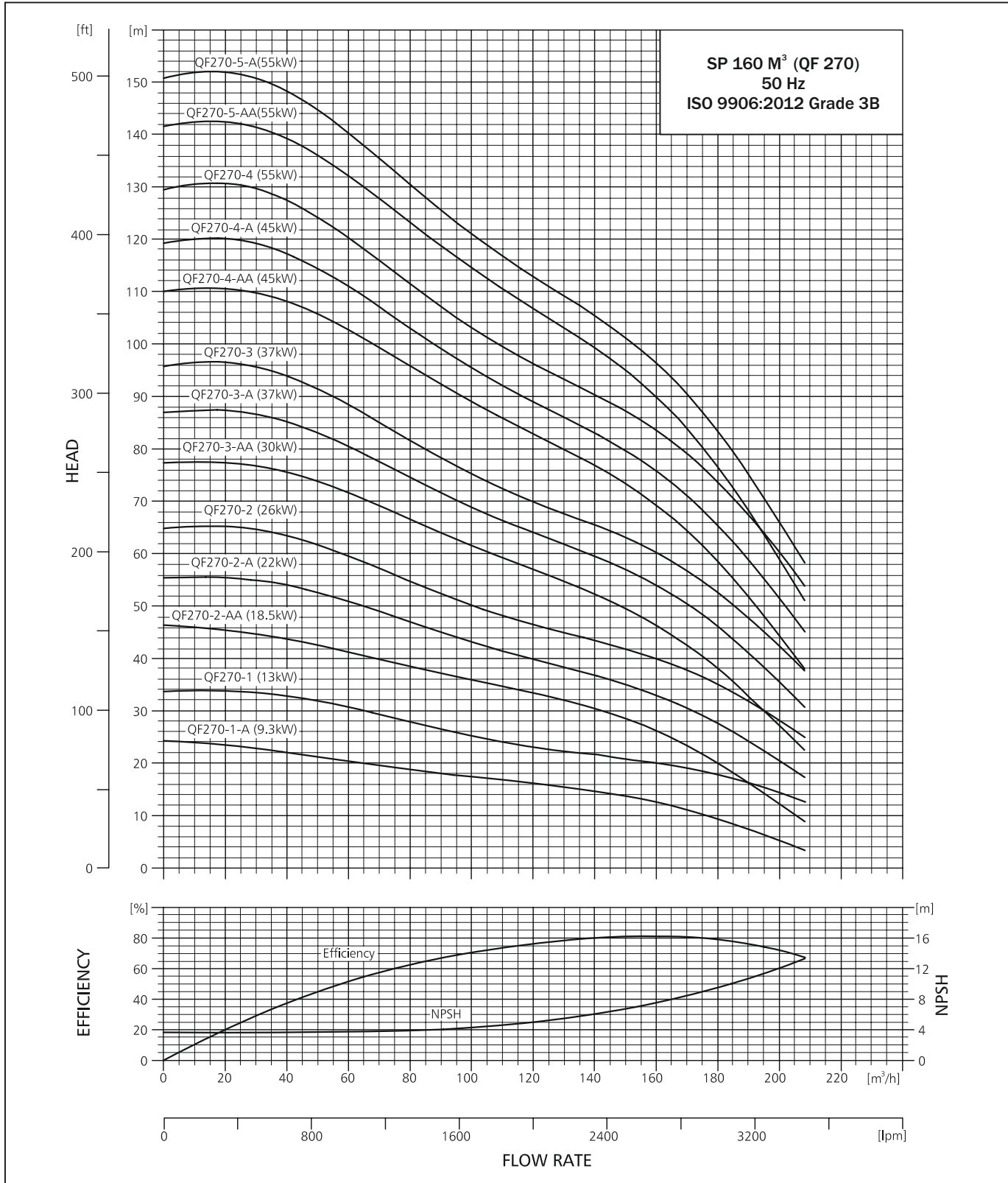

PERFORMANCE CURVE



SUBMERSIBLE PUMP QF 270

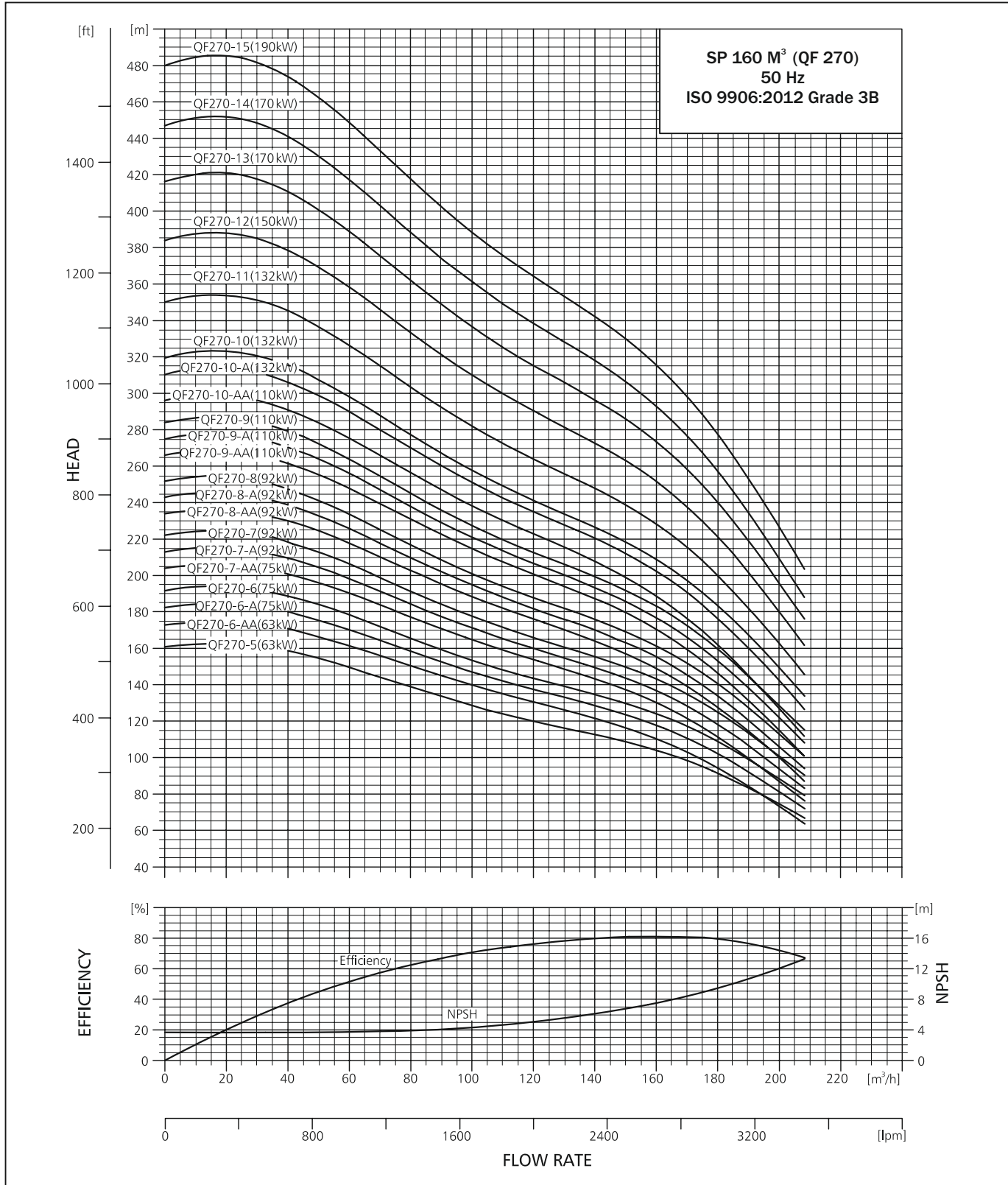

SUBMERSIBLE PUMP QF 270

DIMENSIONS AND WEIGHTS

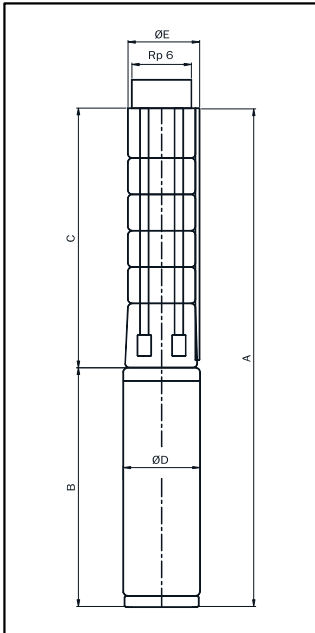

TECHNICAL DATA QF 270

PUMP TYPE	MOTOR		DIMENSIONS (mm)										NET WEIGHT (kg)	
	TYPE	POWER (kW)	Rp 6" CONNECTION				Rp 6" FLANGE				B	D	PUMP	MOTOR
			A	C	E*	E**	A	C	E*	E**				
QF270-1-A	MATASF 150	9.3	1390	641	203	206	1390	641	287	287	749	145	27.1	57
QF270-1	MATASF 150	13	1470	641	203	206	1470	641	287	287	829	145	27.1	64
QF270-2-AA	MATASF 150	18.5	1716	797	203	206	1716	797	287	287	919	145	33.4	73
QF270-2-A	MATASF 150	22	1806	797	203	206	1806	797	287	287	1009	145	33.4	82
QF270-2	MATASF 150	26	1911	797	203	206	1911	797	287	287	1114	145	33.4	98
QF270-3-AA	MATASF 150	30	2167	953	203	206	2167	953	287	287	1214	145	39.7	107
QF270-3-AA	MATASF 200	30	2093	953	205	208	2093	953	287	287	1140	194	39.7	164
QF270-3-A	MATASF 200	37	2093	953	205	208	2093	953	287	287	1140	194	39.7	164
QF270-3	MATASF 200	37	2093	953	205	208	2093	953	287	287	1140	194	39.7	164
QF270-4-AA	MATASF 200	45	2339	1109	205	208	2339	1109	287	287	1230	194	46.0	189
QF270-4-A	MATASF 200	45	2339	1109	205	208	2339	1109	287	287	1230	194	46.0	189
QF270-4	MATASF 200	55	2449	1109	205	208	2449	1109	287	287	1340	194	46.0	203
QF270-5-AA	MATASF 200	55	2605	1265	205	208	2605	1265	287	287	1340	194	52.3	203
QF270-5-A	MATASF 200	55	2605	1265	205	208	2605	1265	287	287	1340	194	52.3	203
QF270-5	MATASF 200	63	2735	1265	205	208	2735	1265	287	287	1470	194	52.3	245
QF270-6-AA	MATASF 200	63	2891	1421	205	208	2891	1421	287	287	1470	194	58.6	245
QF270-6-A	MATASF 200	75	2981	1421	205	208	2981	1421	287	287	1560	194	58.6	245
QF270-6	MATASF 200	75	2981	1421	205	208	2981	1421	287	287	1560	194	58.6	245
QF270-7-AA	MATASF 200	75	3137	1577	205	208	3137	1577	287	287	1560	194	64.9	245
QF270-7-A	MATASF 200	93	3317	1577	205	208	3317	1577	287	287	1740	194	64.9	292
QF270-7	MATASF 200	93	3317	1577	205	208	3317	1577	287	287	1740	194	64.9	292
QF270-8-AA	MATASF 200	93	3473	1733	205	208	3473	1733	287	287	1740	194	71.2	292
QF270-8-A	MATASF 200	93	3473	1733	205	208	3473	1733	287	287	1740	194	71.2	292
QF270-8	MATASF 200	93	3473	1733	205	208	3473	1733	287	287	1740	194	71.2	292
QF270-9-AA	MATASF 10"	110	3419	1889	222	222	3419	1889	287	287	1530	194	79.0	315
QF270-9-A	MATASF 10"	110	3419	1889	222	222	3419	1889	287	287	1530	194	79.0	315
QF270-9	MATASF 10"	110	3419	1889	222	222	3419	1889	287	287	1530	194	79.0	315
QF270-10-AA	MATASF 10"	110	3575	2045	222	222	3575	2045	287	287	1530	194	85.5	315
QF270-10-A	MATASF 10"	130	3705	2045	235	235	3705	2045	287	287	1660	235	85.5	362
QF270-10	MATASF 10"	130	3705	2045	235	235	3705	2045	287	287	1660	235	85.5	362
QF270-11	MATASF 10"	130	3861	2201	235	235	3861	2201	287	287	1660	235	91.6	362
QF270-12	MATASF 10"	150	4127	2357	235	235	4127	2357	287	287	1770	235	97.9	413
QF270-13	MATASF 10"	170	4433	2513	235	235	4433	2513	287	287	1920	235	104.2	449
QF270-14	MATASF 10"	170	4589	2669	235	235	4589	2669	287	287	1920	235	110.5	449

* Maximum diameter of pump with one motor cable.

** Maximum diameter of pump with two motor cable.

Motor type may change as per requirement.

SUBMERSIBLE PUMP QF 270

PERFORMANCE TABLE QF 270

QF-270		DISCHARGE (Q)																					
		m ³ /h	0	80	90	100	110	120	130	140	150	160	170	180	190	200	208						
		l/min.	0	1333	1500	1667	1833	2000	2167	2333	2500	2667	2833	3000	3167	3333	3467						
MODEL	CON-NEC-TION	MATERIAL CODE			MOTOR RATING		TOTAL HEAD IN (m)																
		6x10	8x10	10x10	[kW]	[HP]																	
QF 270 - 1-A		9000003467	-	-	9.3	12.5	24	19	18	17	17	16	15	15	14	13	11	9	7	5	3		
QF 270 - 1		9000003453	-	-	13	17.5	34	28	26	25	24	23	22	22	21	20	19	18	16	14	13		
QF 270 - 2-AA		9000003476	-	-	18.5	25	46	38	37	36	35	33	32	30	29	26	23	20	16	12	9		
QF 270 - 2-A		9000003474	-	-	22	30	55	47	45	43	41	40	38	37	35	33	31	28	24	20	17		
QF 270 - 2		9000003471	-	-	26	35	65	55	52	50	48	46	45	43	42	40	38	35	32	28	25		
QF 270 - 3-AA		9000003484	9000003485	-	30	40	77	67	64	62	59	57	55	52	49	46	42	38	33	27	23		
QF 270 - 3-A		9000009778	9000003482	-	37	50	87	75	72	69	66	64	62	59	57	54	50	46	41	35	31		
QF 270 - 3		9000003479	9000003480	-	37	50	96	82	78	75	72	70	68	65	63	60	57	53	48	42	38		
QF 270 - 4-AA		-	9000003491	-	45	60	110	96	92	89	86	83	80	77	73	69	64	58	52	44	38		
QF 270 - 4-A		-	9000003490	-	45	60	119	103	99	95	92	89	86	83	80	76	71	65	59	51	45		
QF 270 - 4		-	9000003488	-	55	75	129	111	107	103	100	96	93	90	87	83	79	74	67	60	54		
QF 270 - 5-AA		-	9000003498	-	55	75	142	123	119	114	111	107	103	99	95	90	84	76	68	59	51		
QF 270 - 5-A		-	9000003497	-	55	75	151	130	126	121	117	113	109	105	101	96	90	83	75	66	58		
QF 270 - 5		-	9000003495	-	63	85	161	139	133	129	124	120	116	113	109	104	98	91	83	74	67		
QF 270 - 6-AA		-	9000003502	-	63	85	173	150	145	140	135	131	126	121	116	110	103	94	84	73	64		
QF 270 - 6-A		-	9000003501	-	75	100	183	158	153	147	142	137	133	128	123	118	111	102	92	81	72		
QF 270 - 6	Rp 6	-	9000003500	-	75	100	192	166	159	154	148	144	139	135	130	124	117	109	99	88	79		
QF 270 - 7-AA		-	9000003505	-	75	100	204	177	171	165	159	154	149	143	137	130	122	112	100	87	76		
QF 270 - 7-A		-	9000003504	-	92	125	213	184	177	171	165	160	155	149	144	137	128	118	107	94	84		
QF 270 - 7		-	9000003503	-	92	125	222	191	184	177	171	166	161	155	150	143	135	125	113	101	91		
QF 270 - 8-AA		-	9000003508	-	92	125	234	203	195	188	182	176	170	164	157	149	139	127	114	99	87		
QF 270 - 8-A		-	9000003507	-	92	125	243	210	202	195	188	182	176	170	163	155	145	134	121	106	94		
QF 270 - 8		-	9000003506	-	92	125	252	217	208	201	194	188	182	176	169	161	152	140	127	113	101		
QF270-9-AA		-	-	9000003511	110	150	266	231	223	215	207	201	194	187	179	170	159	146	131	115	102		
QF270-9-A		-	-	9000003510	110	150	275	238	229	221	214	207	200	193	186	177	166	153	138	122	109		
QF270-9		-	-	9000003509	110	150	284	245	236	227	220	213	206	199	192	183	172	160	145	129	116		
QF270-10-AA		-	-	9000004612	110	150	296	257	248	239	230	223	216	208	199	189	177	162	145	128	113		
QF270-10-A		-	-	9000003455	132	177	306	264	254	246	238	230	222	214	207	197	184	170	153	135	121		
QF270-10		-	-	9000003454	132	177	316	272	262	252	244	237	229	221	213	203	191	178	161	143	129		
QF270-11		-	-	9000003459	132	177	348	299	288	277	268	261	252	243	234	223	210	196	177	157	142		
QF270-12		-	-	9000003460	150	204	384	332	320	310	300	290	280	272	262	252	237	220	202	180	162		
QF270-13		-	-	9000003462	170	230	416	360	347	336	325	314	303	295	284	273	257	238	219	195	176		
QF270-14		-	-	9000003464	170	230	414	357	345	334	323	312	301	293	282	271	255	237	217	194	174		
QF270-15		-	-	9000003465	190	252	444	383	370	358	346	334	323	314	302	290	273	254	233	208	186		

PERFORMANCE CURVE

SUBMERSIBLE PUMP QF 270

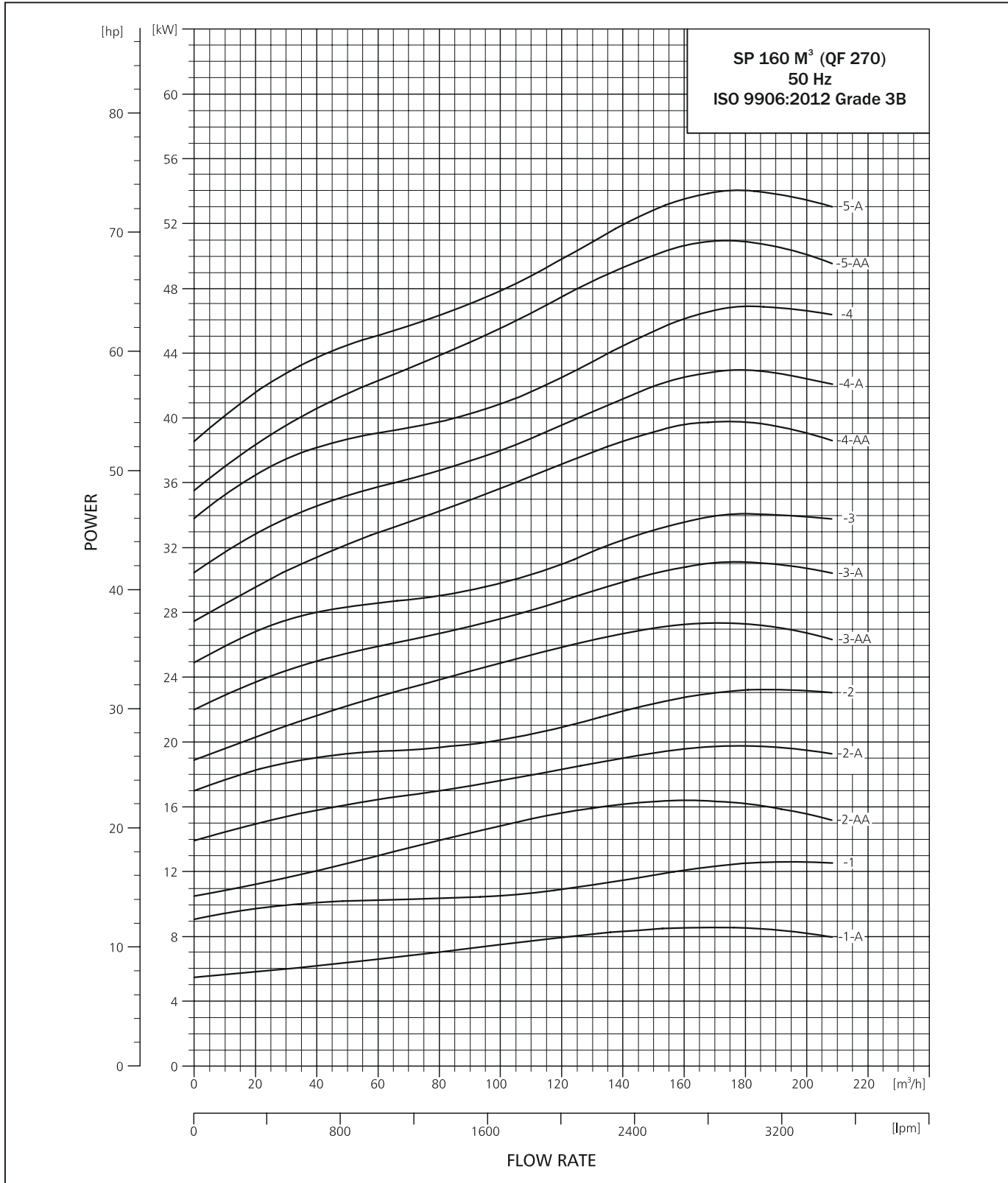

PERFORMANCE CURVE



SUBMERSIBLE PUMP QF 270

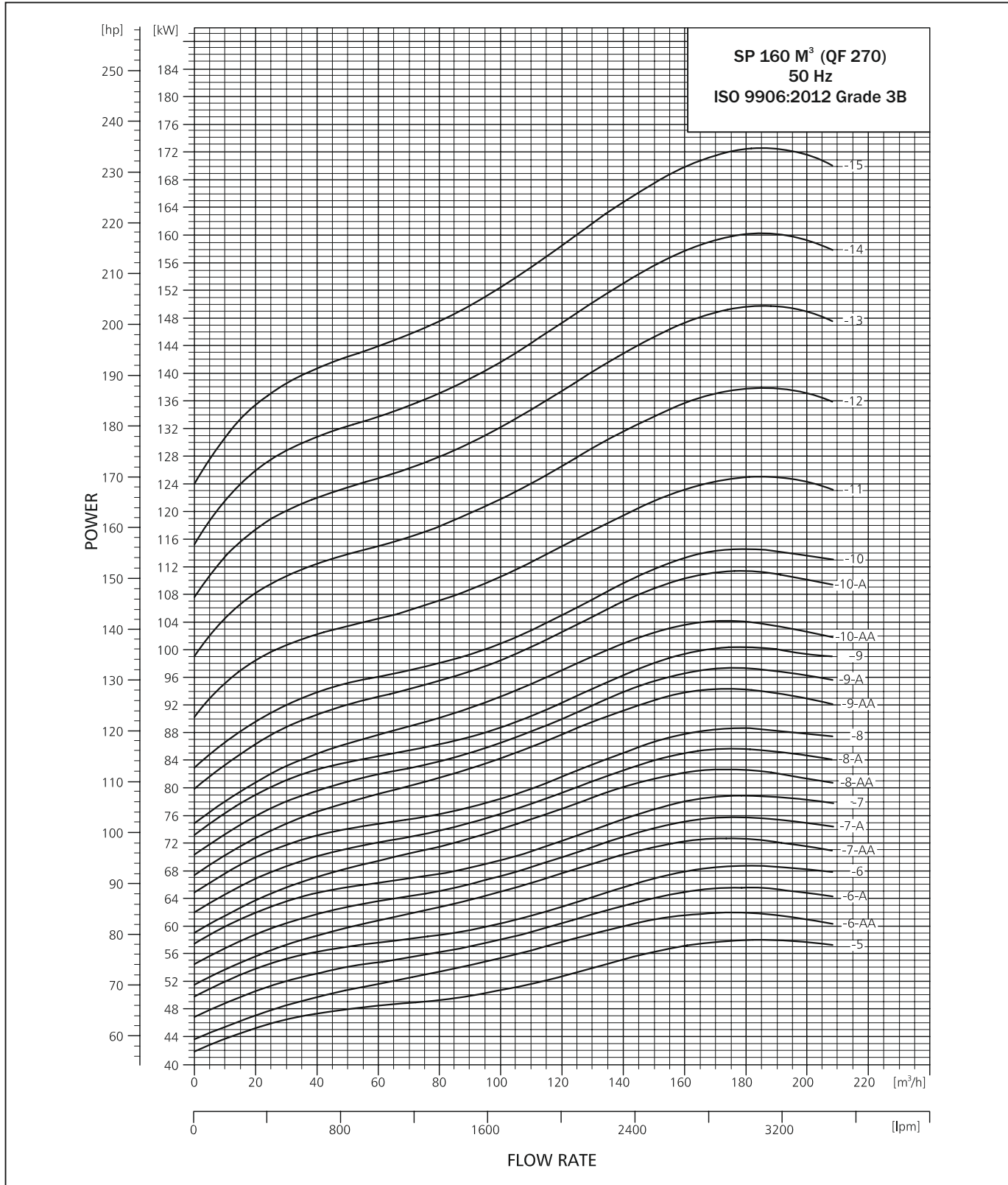

PERFORMANCE CURVE



SUBMERSIBLE PUMP QF 360

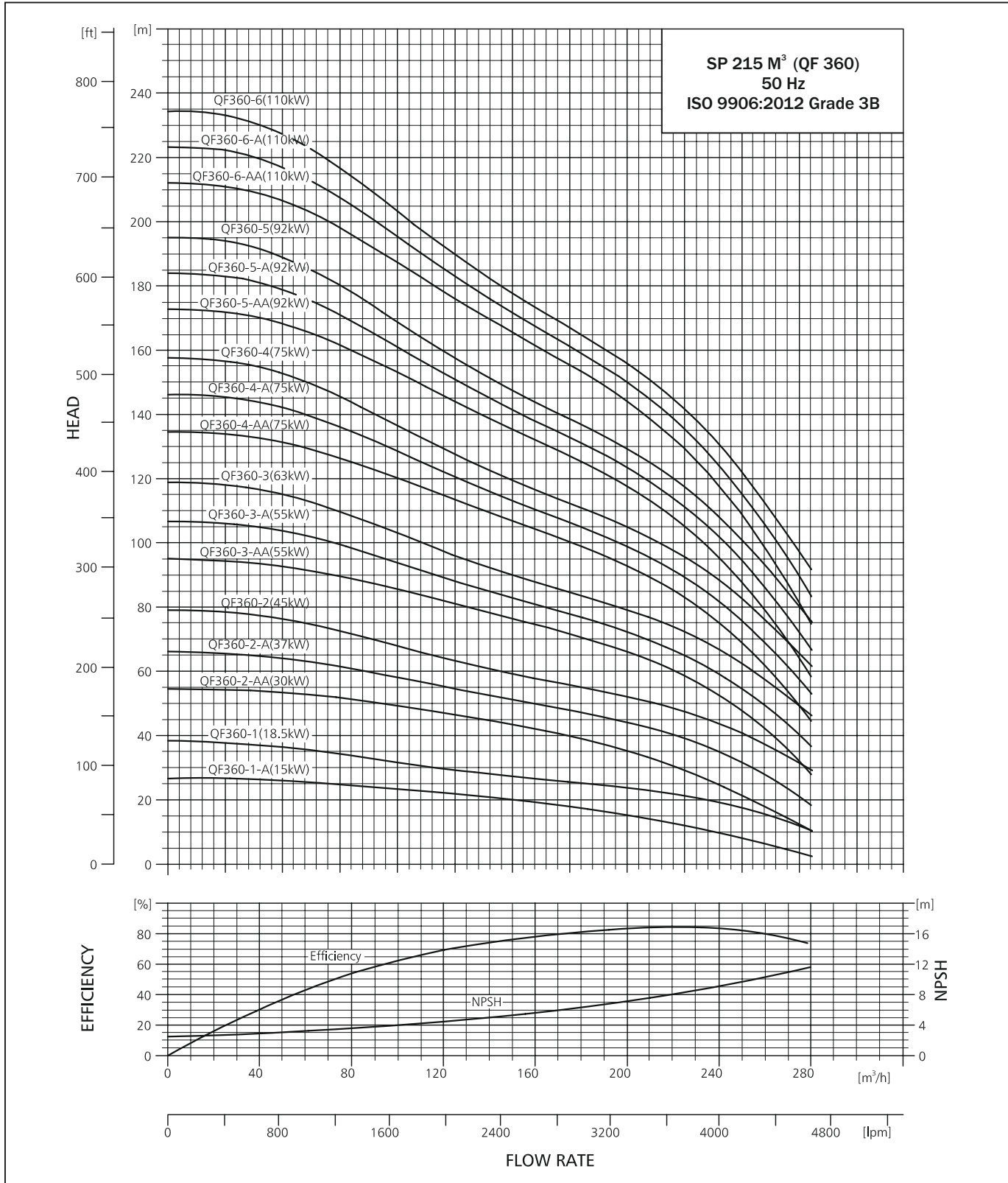

PERFORMANCE CURVE



SUBMERSIBLE PUMP QF 360

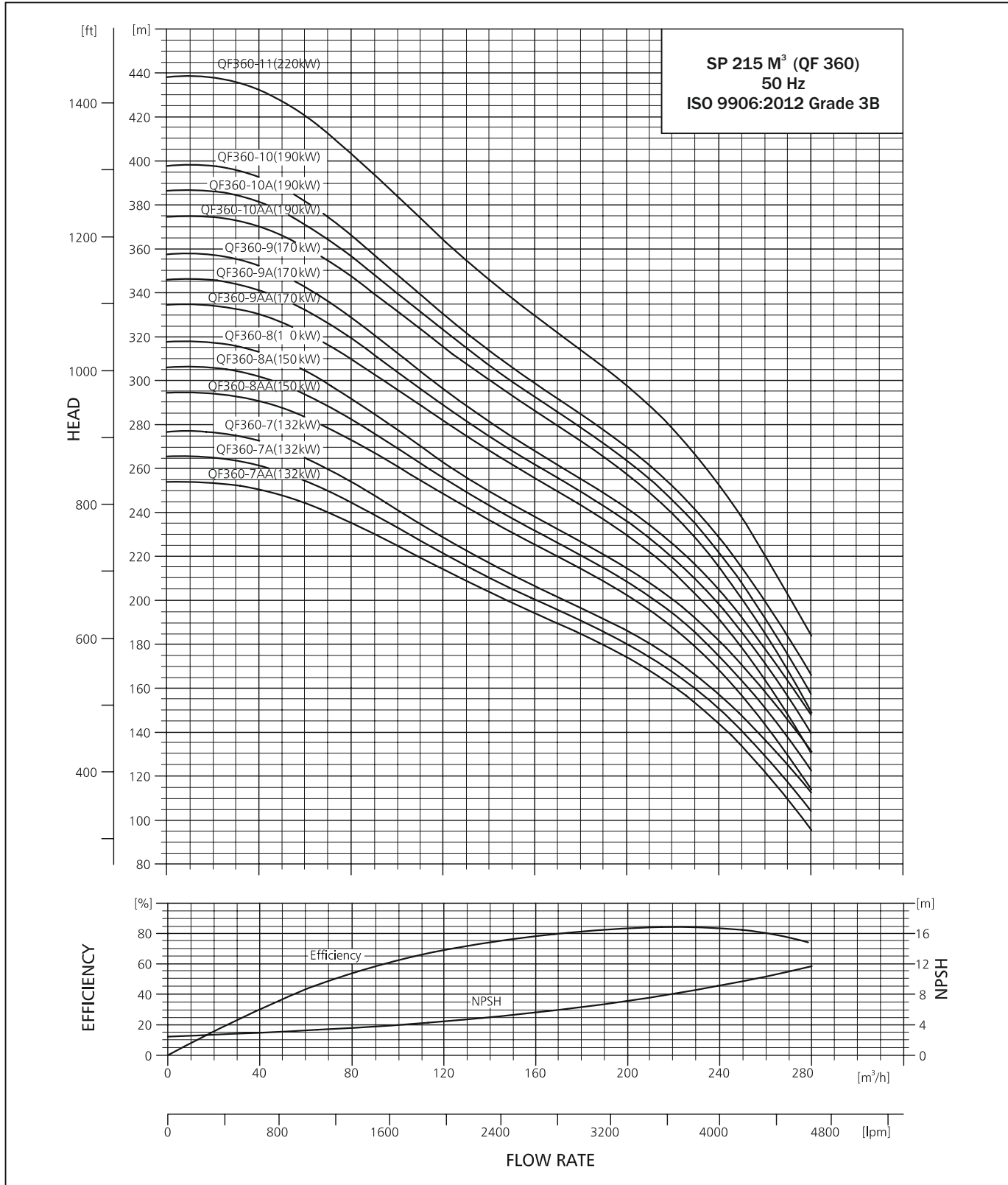

SUBMERSIBLE PUMP QF 360

DIMENSIONS AND WEIGHTS

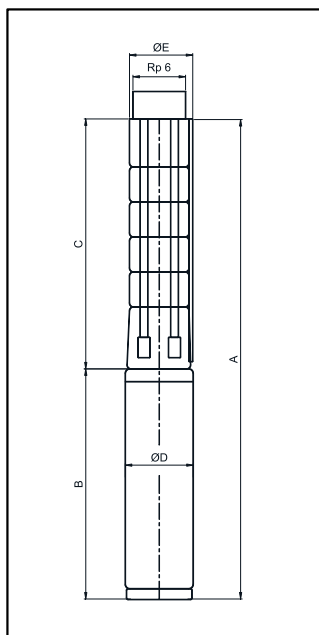

TECHNICAL DATA QF 360

PUMP TYPE	MOTOR		DIMENSIONS (mm)										NET WEIGHT (kg)	
	TYPE	POWER (kW)	Rp 6" CONNECTION				Rp 6" FLANGE				B	D	PUMP	MOTOR
			A	C	E*	E**	A	C	E*	E**				
QF360-1-A	MATASF 150	15	1592	718	227	230	1592	718	287	287	874	145	37.8	70
QF360-1	MATASF 150	18.5	1637	718	227	230	1637	718	287	287	919	145	37.8	82
QF360-2-AA	MATASF 150	30	2108	894	227	230	2108	894	287	287	1214	145	47.9	107
QF360-2-AA	MATASF 200	30	2107	967	233	236	2107	967	287	287	1140	194	57.1	164
QF360-2-A	MATASF 200	37	2107	967	233	236	2107	967	287	287	1140	194	57.1	164
QF360-2	MATASF 200	45	2197	967	233	236	2197	967	287	287	1230	194	57.1	189
QF360-3-AA	MATASF 200	55	2483	1143	233	236	2483	1143	287	287	1340	194	67.3	203
QF360-3-A	MATASF 200	55	2483	1143	233	236	2483	1143	287	287	1340	194	67.3	203
QF360-3	MATASF 200	63	2613	1143	233	236	2613	1143	287	287	1470	194	67.3	245
QF360-4-AA	MATASF 200	75	2879	1319	233	236	2879	1319	287	287	1560	194	77.4	245
QF360-4-A	MATASF 200	75	2879	1319	233	236	2879	1319	287	287	1560	194	77.4	245
QF360-4	MATASF 200	75	2879	1319	233	236	2879	1319	287	287	1560	194	77.4	245
QF360-5-AA	MATASF 200	92	3235	1495	233	236	3235	1495	287	287	1740	194	87.6	292
QF360-5-A	MATASF 200	92	3235	1495	233	236	3235	1495	287	287	1740	194	87.6	292
QF360-5	MATASF 200	92	3235	1495	233	236	3235	1495	287	287	1740	194	87.6	292
QF360-6-AA	MATASF 10"	110	3201	1671	235	236	3201	1671	287	287	1530	235	98.9	315
QF360-6-A	MATASF 10"	110	3201	1671	235	236	3201	1671	287	287	1530	235	98.9	315
QF360-6	MATASF 10"	110	3201	1671	235	236	3201	1671	287	287	1530	235	98.9	315
QF360-7-AA	MATASF 10"	130	3507	1847	235	236	3507	1847	287	287	1660	235	109.0	362
QF360-7-A	MATASF 10"	130	3507	1847	235	236	3507	1847	287	287	1660	235	109.0	362
QF360-7	MATASF 10"	130	3507	1847	235	236	3507	1847	287	287	1660	235	109.0	362
QF360-8-AA	MATASF 10"	150	3793	2023	235	236	3793	2023	287	287	1770	235	119.1	413
QF360-8-A	MATASF 10"	150	3793	2023	235	236	3793	2023	287	287	1770	235	119.1	413
QF360-8	MATASF 10"	150	3793	2023	235	236	3793	2023	287	287	1770	235	119.1	413
QF360-9-AA	MATASF 10"	170	4119	2199	235	236	4119	2199	287	287	1920	235	129.3	449
QF360-9-A	MATASF 10"	170	4119	2199	235	236	4119	2199	287	287	1920	235	129.3	449
QF360-9	MATASF 10"	170	4119	2199	235	236	4119	2199	287	287	1920	235	129.3	449
QF360-10-AA	MOTOR 12"	185	4268	2375	286	286	4268	2375	287	287	1893	286	139.4	632
QF360-10-A	MOTOR 12"	185	4268	2375	286	286	4268	2375	287	287	1893	286	139.4	632
QF360-10	MOTOR 12"	190	4268	2375	286	286	4268	2375	287	287	1893	286	139.4	632
QF360-11	MOTOR 12"	220	4444	2551	286	286	4444	2551	287	287	1893	286	149.6	653

* Maximum diameter of pump with one motor cable.
 ** Maximum diameter of pump with two motor cable.
 Motor type may change as per requirement.

TECHNICAL DATA



SUBMERSIBLE PUMP QF 360

PERFORMANCE TABLE QF 360

QF-360					DISCHARGE (Q)																			
					m ³ /h	0	90	110	130	150	170	180	190	200	210	220	230	240	250	260	270	280		
					l/min.	0	1500	1833	2167	2500	2833	3000	3167	3333	3500	3667	3833	4000	4167	4333	4500	4667		
MODEL	MATERIAL CODE				MOTOR RATING		TOTAL HEAD IN (m)																	
	6x12	8x12	10x12	12x12	[kW]	[HP]	27	24	23	22	20	18	17	16	15	14	13	11	10	8	6	4	3	
QF 360 - 1-A	9000003524	-	-	-	15	20	27	24	23	22	20	18	17	16	15	14	13	11	10	8	6	4	3	
QF 360 - 1	9000003513	-	-	-	18.5	25	38	33	31	29	27	26	25	24	24	23	22	21	19	18	16	13	11	
QF 360 - 2-AA	9000010313	9000003534	-	-	30	40	55	50	48	46	43	41	39	37	35	33	31	28	25	21	18	14	11	
QF 360 - 2-A	9000003529	9000003530	-	-	37	50	66	59	57	54	51	49	47	46	44	42	40	38	35	32	28	23	18	
QF 360 - 2	-	9000003526	-	-	45	60	79	70	66	62	59	56	55	54	52	50	49	46	44	41	37	34	19	
QF 360 - 3-AA	-	9000003543	-	-	55	75	95	87	84	80	76	73	71	69	66	63	60	57	53	48	42	36	28	
QF 360 - 3-A	-	9000003540	-	-	55	75	107	96	92	87	83	79	77	75	72	70	67	63	59	55	49	43	37	
QF 360 - 3	-	9000003537	-	-	63	85	119	106	100	95	90	86	84	81	79	77	74	71	67	62	58	52	46	
QF 360 - 4-AA	-	9000003552	-	-	75	100	135	123	117	112	107	102	99	96	93	89	85	80	75	69	62	54	45	
QF 360 - 4-A	-	9000003549	-	-	75	100	146	132	125	119	113	108	105	102	99	95	91	87	82	76	69	61	53	
QF 360 - 4	-	9000003546	-	-	75	100	158	140	133	126	119	114	111	108	105	102	98	93	88	82	76	69	62	
QF 360 - 5-AA	-	9000003562	-	-	92	125	173	157	149	142	135	129	125	122	118	113	108	102	95	88	79	69	59	
QF 360 - 5-A	-	9000003559	-	-	92	125	184	165	157	149	141	135	131	127	123	119	114	108	102	94	86	77	67	
QF 360 - 5	-	9000003555	-	-	92	125	195	173	164	155	148	140	137	133	129	125	120	114	108	101	93	84	76	
QF 360 - 6-AA	-	-	-	-	110	150	212	192	183	174	166	157	153	149	144	139	133	126	118	109	98	87	75	
QF 360 - 6-A	-	-	9000017871	-	110	150	223	200	190	181	172	163	159	155	150	145	139	132	124	115	105	95	83	
QF 360 - 6	-	-	9000003565	-	110	150	234	209	198	187	178	169	165	160	156	151	145	138	130	122	112	102	92	
QF 360 - 7-AA	-	-	9000003578	-	132	177	254	230	220	209	199	190	185	180	174	168	161	153	144	134	122	109	96	
QF 360 - 7-A	-	-	9000003576	-	132	177	265	239	227	216	205	196	191	186	180	174	167	159	151	141	129	117	104	
QF 360 - 7	-	-	9000003574	-	132	177	277	248	235	223	212	202	197	192	186	180	174	166	157	147	137	125	113	
QF 360 - 8-AA	-	-	9000003584	-	150	204	295	267	255	242	231	220	214	209	202	195	188	179	168	157	144	129	114	
QF 360 - 8-A	-	-	9000003582	-	150	204	306	276	263	249	237	226	221	215	209	202	194	185	175	164	151	137	123	
QF 360 - 8	-	-	9000003580	-	150	204	318	285	270	256	244	232	227	221	215	208	200	192	182	171	158	145	131	
QF 360 - 9-AA	-	-	9000003590	-	170	230	334	303	289	275	262	249	243	237	230	222	213	203	191	178	164	148	131	
QF 360 - 9-A	-	-	9000003588	-	170	230	346	312	297	282	268	256	249	243	236	228	219	209	198	185	171	156	140	
QF 360 - 9	-	-	9000003586	-	170	230	358	321	305	289	275	262	255	249	242	234	226	216	205	192	179	164	148	
QF 360 - 10-AA	-	-	-	9000003519	190	260	375	340	324	308	293	279	272	265	257	249	239	228	215	201	185	168	149	
QF 360 - 10-A	-	-	-	9000003517	190	260	386	349	331	315	300	286	279	271	264	255	245	234	222	208	192	175	158	
QF 360 - 10	-	-	-	9000003515	190	260	398	357	339	322	306	292	285	277	270	261	252	241	229	215	200	183	166	
QF 360 - 11	-	-	-	9000003521	220	300	438	393	373	354	337	321	314	305	297	287	277	265	252	237	220	201	183	

PERFORMANCE CURVE



SUBMERSIBLE PUMP QF 360

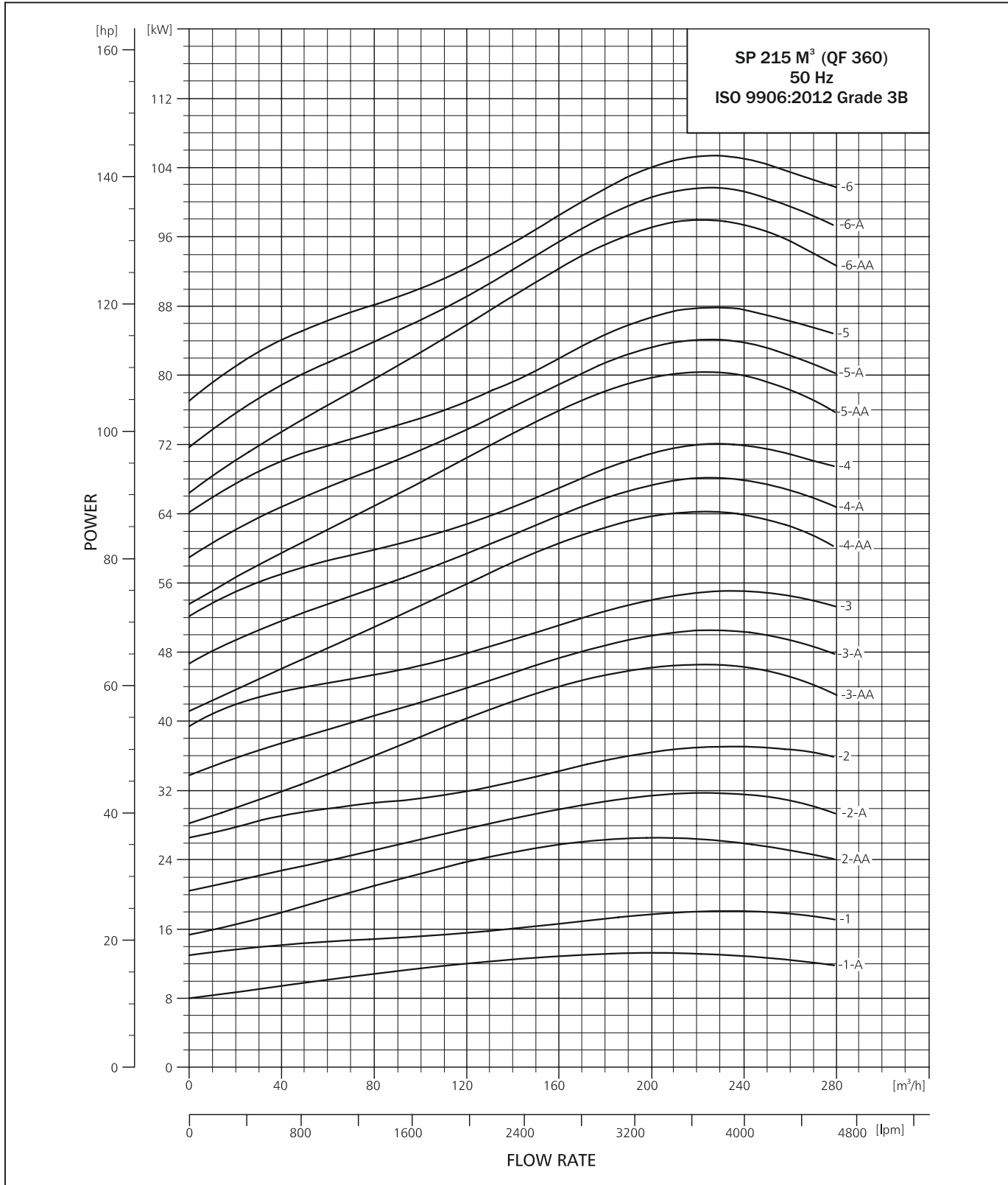

PERFORMANCE CURVE



SUBMERSIBLE PUMP QF 360

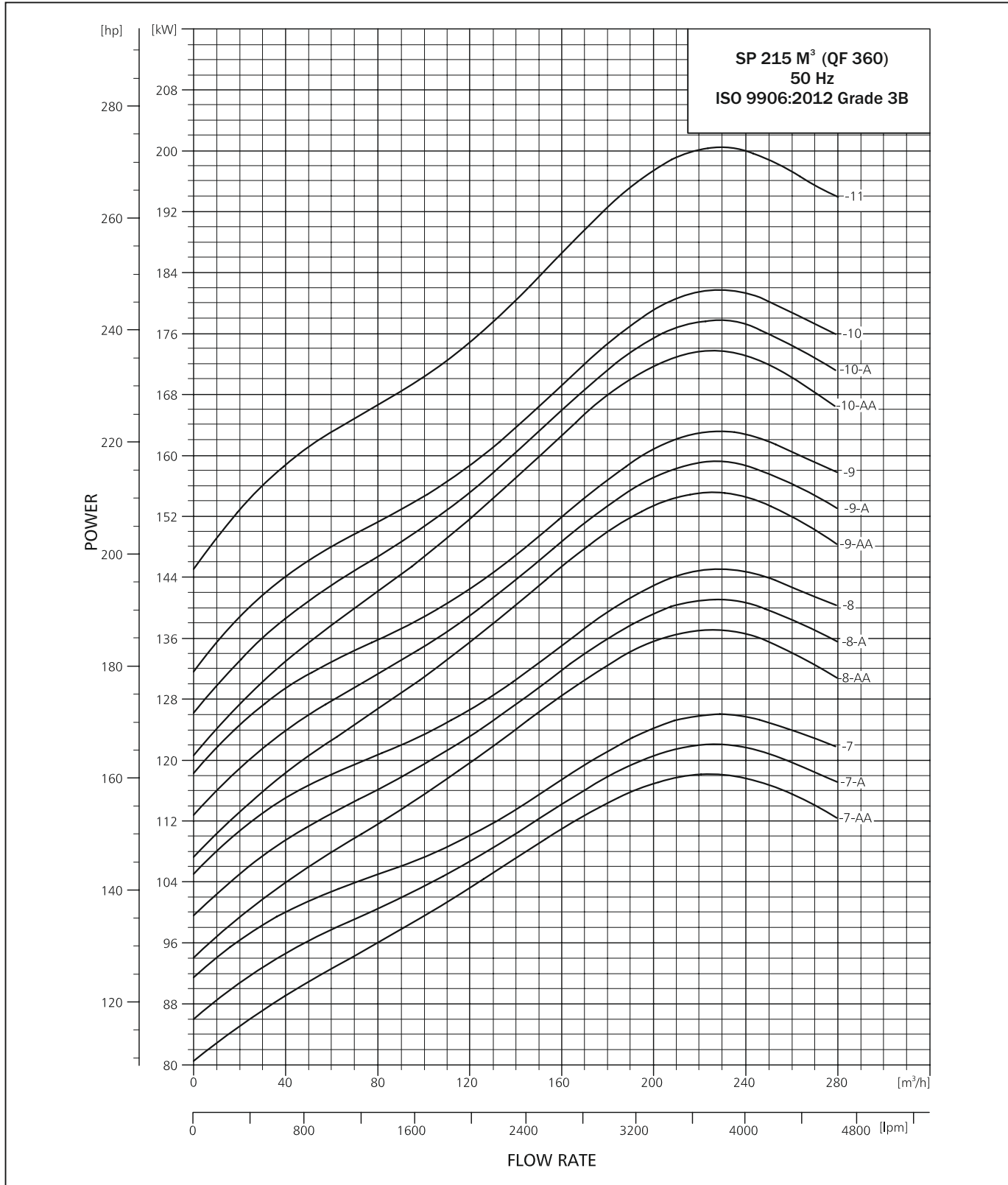

V14 PUMPS

SSP GENERAL DATA (SSP 270, SSP300, SSP 360)

14" WELL SIZE

Models

SSP 270 (SP 270 G m³/h)

SSP 300 (SP 300 G m³/h)

SSP 360 (SP 360 G m³/h)

Operating Condition

Flow Rate, Q - 24 - 430 m³/h

Head, H - Max. 410 meter

Material

Diffuser - Cast Iron

Impeller - Bronze

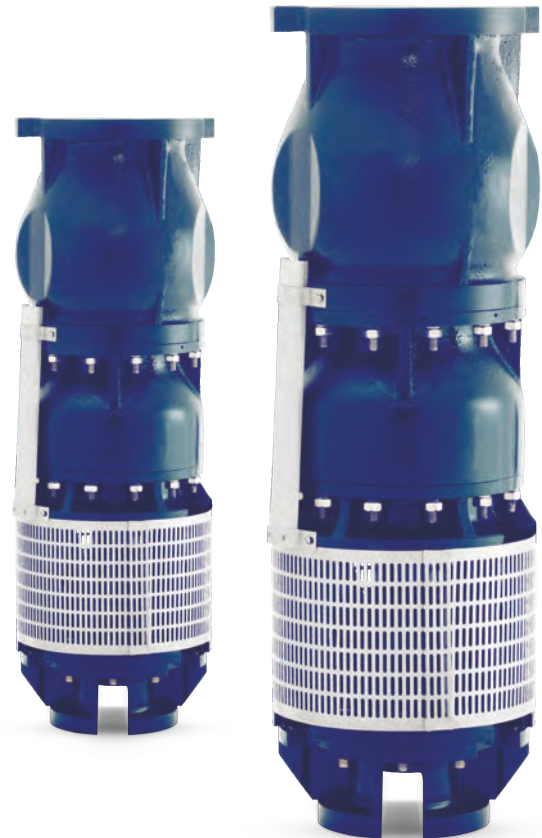

V14 PUMPS



PUMP RANGE

Type	SSP 270	SSP 300	SSP360
Cast Iron	+	+	+
DIN Connection	DIN 175	DIN 175	DIN 175

MOTOR RANGE

Motor Output 1kW]	22	26	30	37	45	55	75	93	110	132	147	170	190	220
Three Phase	+	+	+	+	+	+	+	+	+	+	+	+	+	+
Rewindable Motor	+	+	+	+	+	+	+	+	+	+	+	+	+	+
Steel: AISI 304	+	+	+	+	+	+	+	+	+	+	+	+	+	+
Steel: AISI 304 & Cast Iron	+	+	+	+	+	+	+	+	+	+	+	+	+	+

Soft starter or auto transformer is recommended above 75 kW, see soft starting. The MMS motors can be operated via frequency converter see Frequency converter operation.

Motors with star-delta are available for all motor sizes.

TYPE KEY

Example SSP 270-2 A	SSP	270	2	A
Type range				
Rated flow in m3/h				
Number of impellers				
Impeller type				

PUMPED LIQUIDS

Clean, thin, non-aggressive liquids without solid particles or fibers.

Maximum sand contents : 50 g/m³

OPERATING CONDITIONS

Flow Rate, Q	:	24-430 m ³ /h
Head, H	:	Maximum 410 m
Operating Pressure	:	Maximum 60 bar
Storage temperature	:	Pump: -20 °C to +60 °C Motor: -20 °C to +70 °C.

Motor	Installation		
	Flow velocity past motor	Vertical	Horizontal
8", 10" & 12"	0.15 m/s	40 °C	40 °C

V14 PUMPS

FEATURES & BENEFITS

PUMP RANGE

The SSP pump range consists of pumps which can deliver a higher pressure or a higher flow compared to the rest of the QF pump range offered by Shakti.

SSP Pumps are semi-axial pumps. They are suitable for applications requiring a flow up to 430 m³/h and a head up to 410 m head.

All pumps are available with an optional number of stages to match any duty point.

PRODUCT FEATURES

Bearings with sand channels

All bearings are constructed in such a way that channels are formed along the shaft enabling sand, if any, to leave the pump with the pumped liquid.

The bearings in SSP Pumps are Octagonal on the inside.

INLET STRAINER (Fig. no. 1)

The inlet strainer prevents particles over a certain size from entering and damaging the pump.

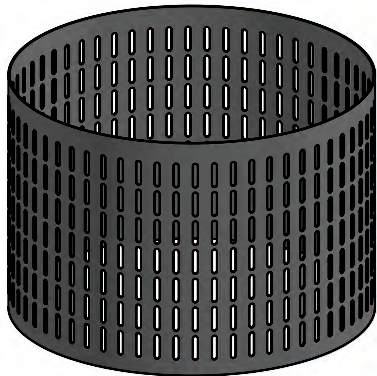

(Fig. no. 1)

PROTECTION AGAINST UP THRUST (Fig. no.2)

The pump range has a screwed connection between the coupling of the pump and the motor shaft ensuring that upthrust in the pump, if any, is transferred to the stop ring of the motor.

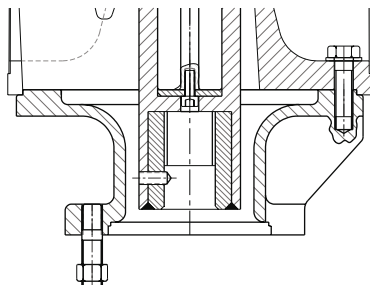

(Fig. no. 2)

VALVE CASING (Fig. no.3)

All pumps are equipped with a reliable non-return valve in the valve casing preventing back flow in connection with pump stoppage.

The valve casing is designed for optimum hydraulic properties to minimize the pressure loss across the Valve and thus contribute to minimizing the total pressure loss of the pump.

Furthermore, the short closing time of the non-return valve means that the risk of destructive water hammer is reduced to a minimum.

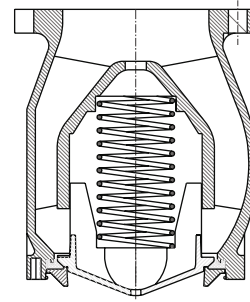

(Fig. no. 3)

NECK RING (Fig. no.4)

All pumps have a replaceable neck ring in each chamber.

This means that the neck ring can be replaced easily in case of wear.

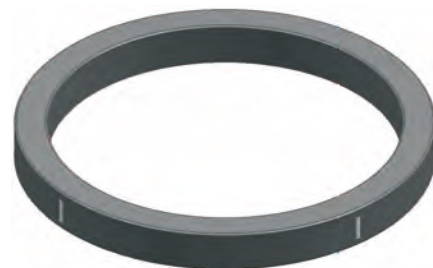

(Fig. no. 4)

PERFORMANCE RANGE

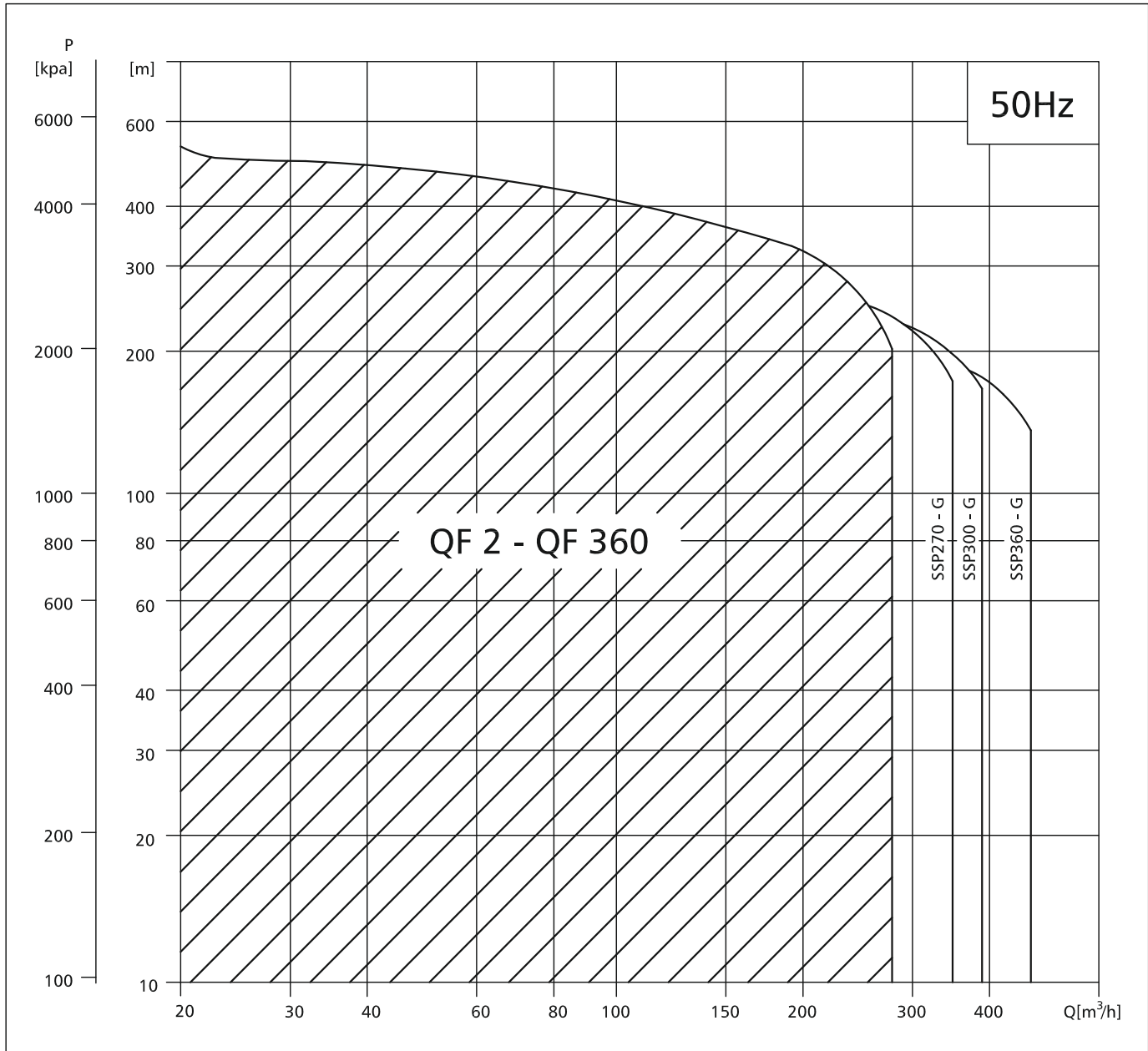

SUBMERSIBLE PUMPS

SUBMERSIBLE PUMP SSP-270

MATERIAL SPECIFICATION SSP-270

SR.NO.	DESCRIPTION	MATERIAL	MATERIAL
1	VALVE CASING	CAST IRON	CI-FG-260
1d	BOWL O-RING	RUBBER	NBR
2	VALVE CUP	BRONZE	LBT-2
3	VALVE SEAT	RUBBER	NBR
3a	VALVE SEAT RETAINER	BRONZE	LBT-2
4	TOP CHAMBER	CAST IRON	CI-FG-260
6	TOP BEARING BUSH	BRONZE	LBT-4
7	WEARING RING	BRONZE	LBT-4
8	BEARING BUSH	SS+RUBBER	SS-304+NBR
9	INTER CHAMBER	CAST IRON	CI-FG-260
12	BEARING SLEEVE	STAINLESS STEEL	AISI SS-304
13	IMPELLER	BRONZE	LBT-2
14	SUCTION INTERCONNECTOR	CAST IRON	CI-FG-260
15	STRAINER	STAINLESS STEEL	AISI SS-304
16	SHAFT	STAINLESS STEEL	DUPLEX
18	CABLE GUARD	STAINLESS STEEL	AISI SS-304
24	COUPLING	STAINLESS STEEL	AISI SS-304
35a	STUD	STAINLESS STEEL	AISI SS-304
35b	NUT	STAINLESS STEEL	AISI SS-304
73	SUCTION CASE ADOPTER	CAST IRON	CI-FG-260

SECTIONAL VIEW OF SSP-270 PUMP ASSLY

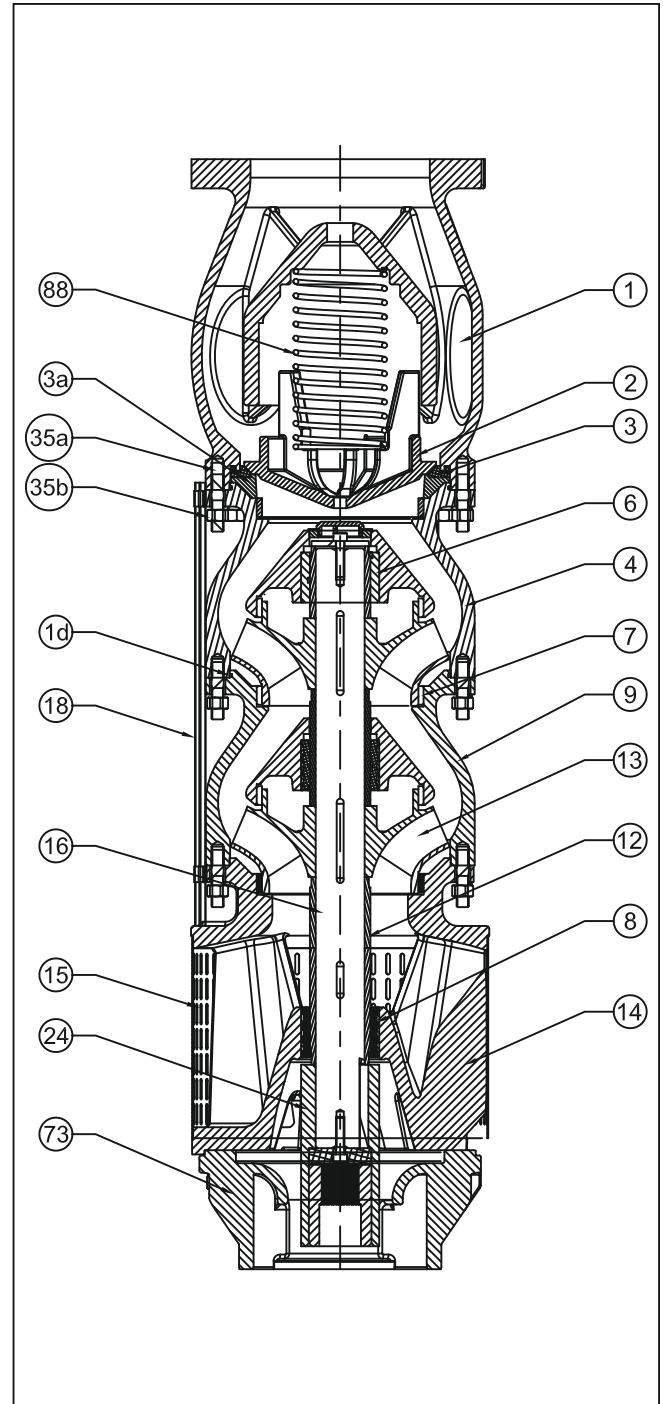

PERFORMANCE CURVE



SUBMERSIBLE PUMP SSP-270

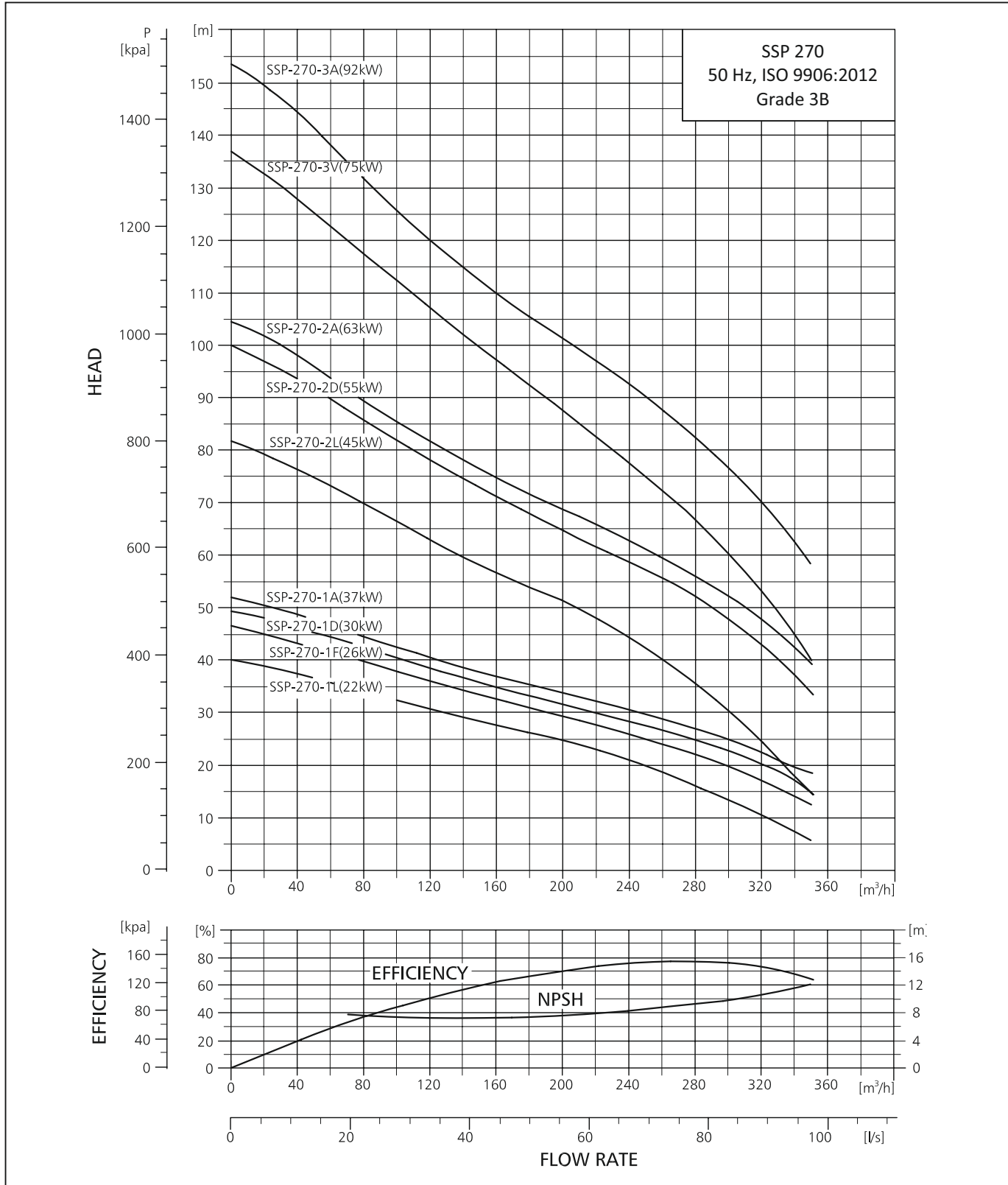

PERFORMANCE CURVE



SUBMERSIBLE PUMP SSP-270

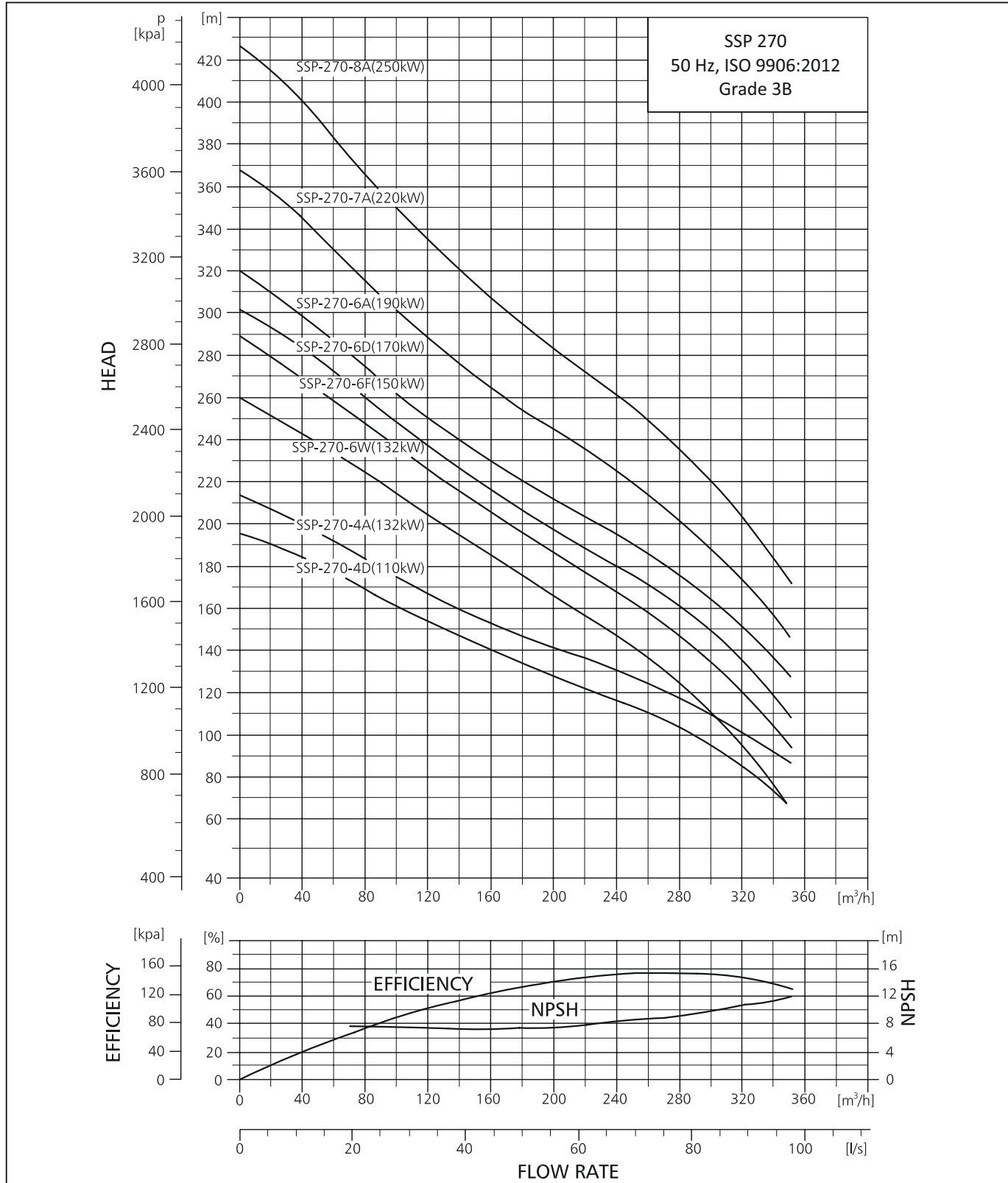

SUBMERSIBLE PUMP SSP-270

DIMENSIONS AND WEIGHTS

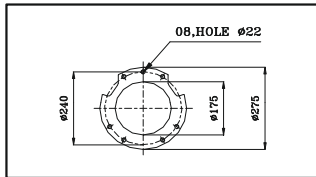
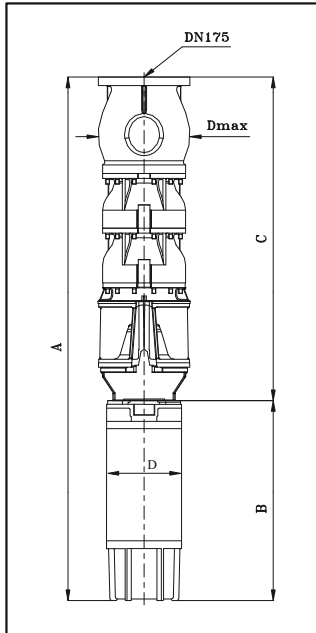

TECHNICAL DATA SSP-270

PUMP TYPE	MOTOR		DIMENSIONS (MM)				NET WEIGHT (KG) PUMPS SET
	TYPE	POWER (kW)	C	B	A	D	
SSP 270-1L	MATSFC8"	22	885	1040	1925	194	266
SSP 270-1F	MATSFC8"	26	885	1140	2025	194	274
SSP 270-1D	MATSFC8"	30	885	1140	2025	194	286
SSP 270-1A	MATSFC8"	37	885	1140	2025	194	296
SSP 270-2L	MATSFC8"	45	1065	1230	2295	194	342
SSP 270-2D	MATSFC8"	55	1065	1340	2405	194	357
SSP 270-2A	MATSFC8"	63	1065	1470	2535	194	383
SSP 270-3V	MATSFC8"	75	1245	1560	2805	194	427
SSP 270-3A	MATSFC8"	93	1245	1740	2985	194	473
SSP 270-4D	MATSF10"	110	1425	1529	2954	235	605
SSP 270-4A	MATSF10"	130	1425	1659	3084	235	655
SSP 270-6W	MATSF10"	130	1785	1659	3444	235	705
SSP 270-6F	MATSF10"	150	1785	1769	3554	235	770
SSP 270-6D	MATSF10"	170	1785	1919	3704	235	890
SSP 270-6A	MATSF10"	185	1785	1919	3704	235	935
SSP 270-7A	MATSF12"	220	1965	1893	3858	286	1010
SSP 270-8A	MATSF12"	250	2145	1893	4038	286	1100

Dmax (6",8",10" and 12") :290mm

PERFORMANCE TABLE SSP 270

SSP 270		DISCHARGE (Q)														
		m ³ /h	0	40	80	120	160	200	240	280	320					
		l/min.	0	668	1336	2004	2672	3340	4008	4676	5344					
MODEL	MATERIAL				MOTOR RATING		TOTAL HEAD IN (m)									
	6" joining	8" joining	10" joining	12" joining	[kW]	[HP]	41	38	34	30	28	25	21	17	10	
SSP270-1 L	9000010964	-	-	-	22	30	41	38	34	30	28	25	21	17	10	
SSP270-1F	9000010961	-	-	-	26	35	47	44	40	37	33	30	27	23	18	
SSP270-1D	9000010962	-	-	-	30	40	49	47	43	39	35	32	29	25	20	
SSP270-1A	9000010963	-	-	-	37	50	52	49	45	41	37	33	30	27	23	
SSP270-2L	-	9000018456	-	-	45	60	80	76	69	62	56	50	44	35	24	
SSP270-2D	-	9000010965	-	-	55	75	98	92	85	77	70	63	58	51	42	
SSP270-2A	-	9000010966	-	-	63	85	103	96	88	80	73	68	62	55	46	
SSP270-3V	-	9000010967	-	-	75	100	136	128	117	106	96	87	73	67	51	
SSP270-3A	-	9000010968	-	-	92	125	155	145	133	121	111	102	93	83	71	
SSP270-4D	-	-	9000010969	-	110	150	197	185	170	155	141	129	117	104	87	
SSP270-4A	-	-	9000010970	-	132	177	207	194	178	162	149	137	126	113	96	
SSP270-6W	-	-	9000010971	-	132	177	253	238	219	199	181	162	143	119	90	
SSP270-6F	-	-	9000010972	-	147	197	283	266	242	220	199	181	164	144	115	
SSP270-6D	-	-	9000010973	-	185	252	296	277	255	234	213	194	177	158	132	
SSP270-6A	-	-	9000010974	-	185	252	311	290	267	243	223	205	189	170	146	
SSP270-7A	-	-	-	9000010975	220	295	362	338	310	283	260	239	221	197	169	
SSP270-8A	-	-	-	9000010976	250	335	414	387	355	324	297	274	252	226	193	

This Performance Table is Approximate as a Performance Curve
 Technical Change without notice

PERFORMANCE CURVE

SUBMERSIBLE PUMP SSP-270

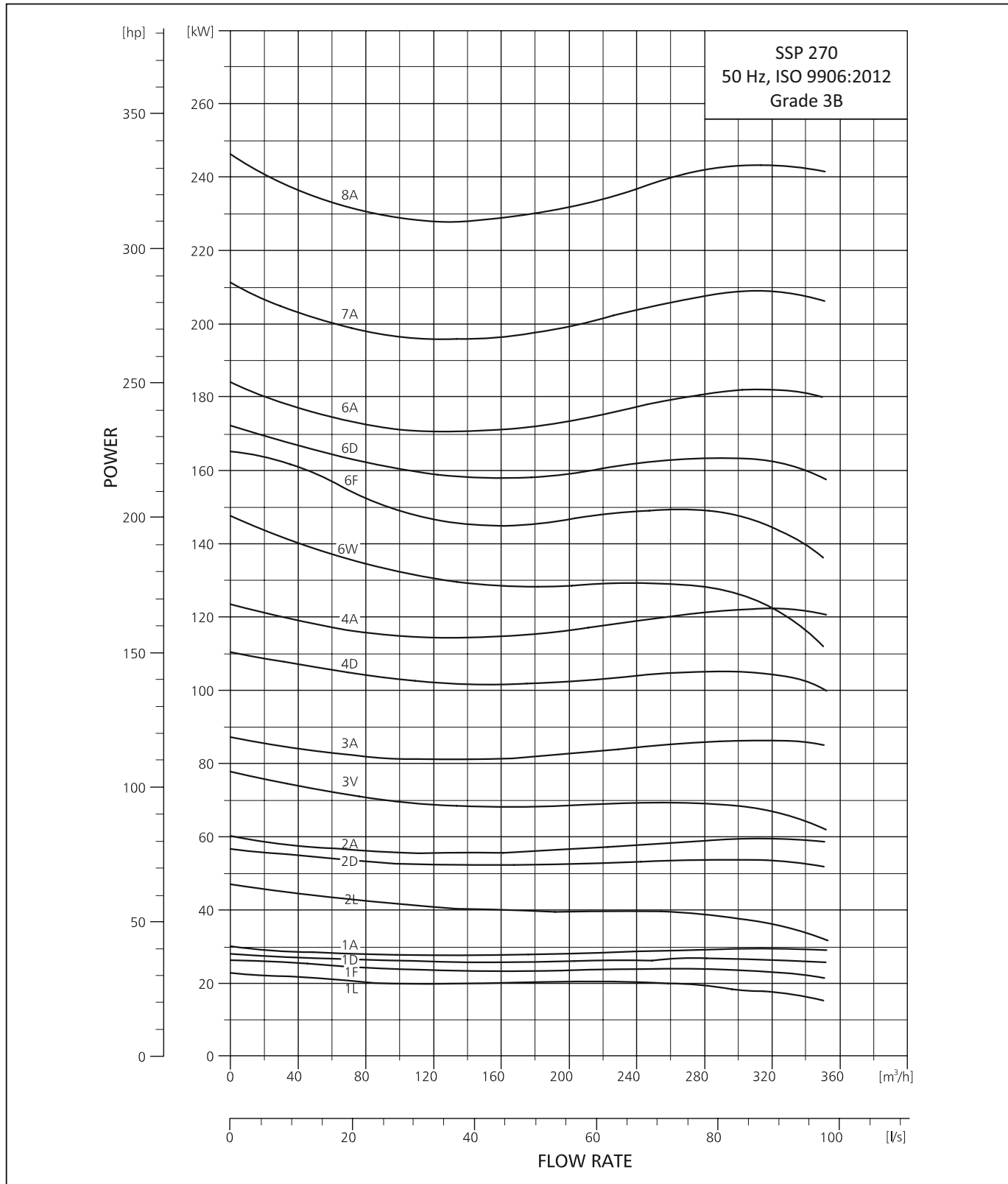

PERFORMANCE CURVE



SUBMERSIBLE PUMP SSP-300

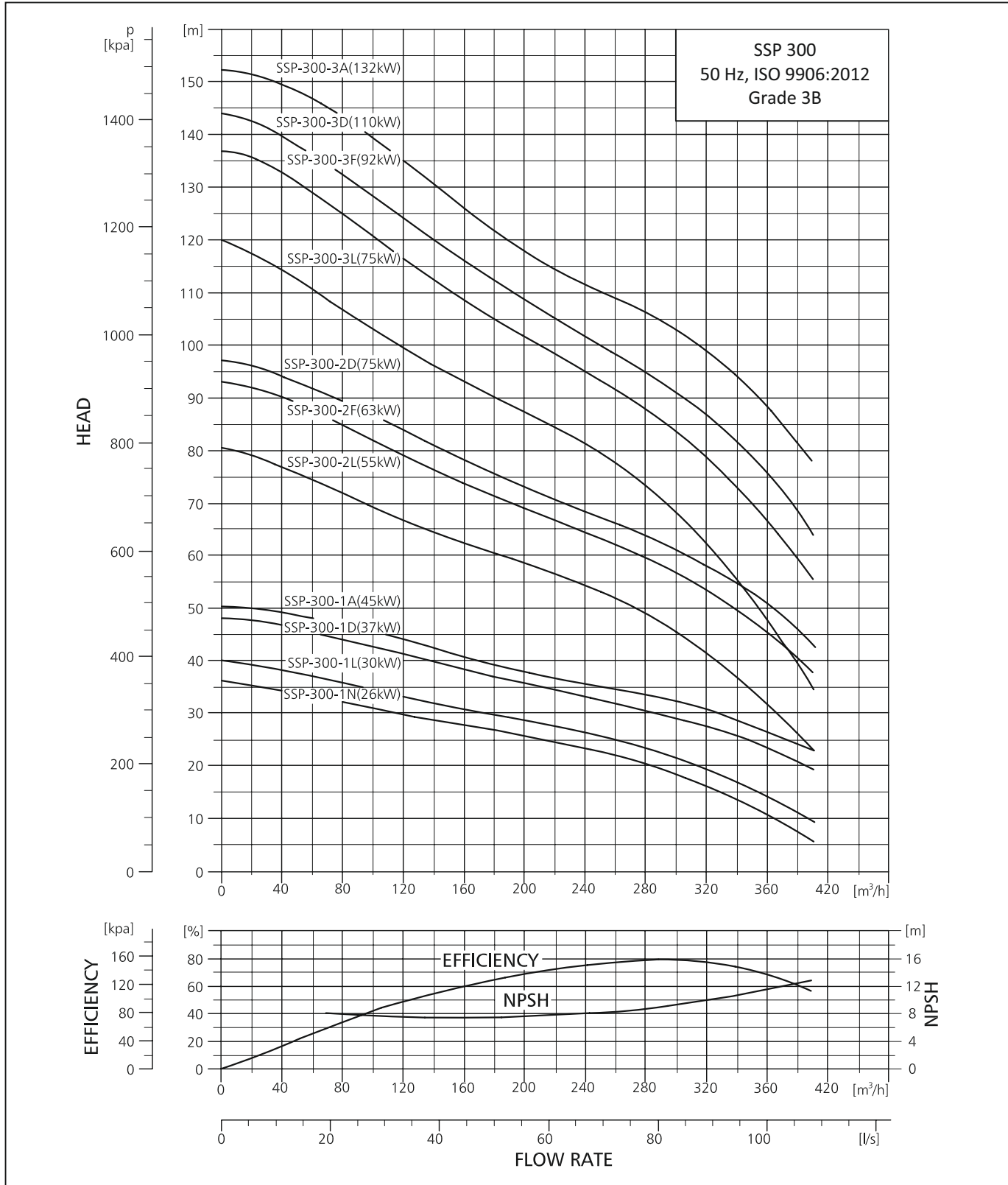

PERFORMANCE CURVE



SUBMERSIBLE PUMP SSP-300

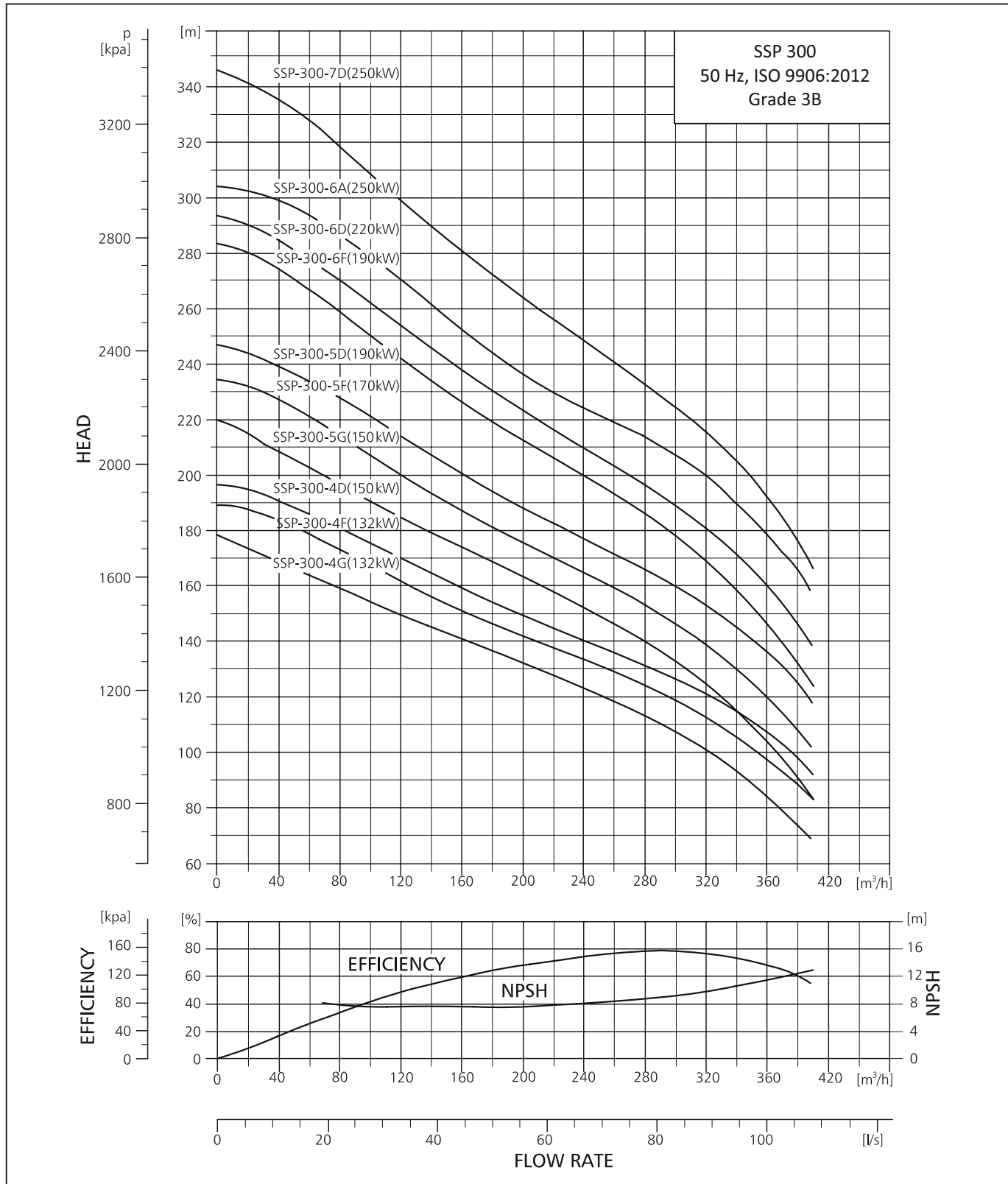

SUBMERSIBLE PUMP SSP-300

DIMENSIONS AND WEIGHTS

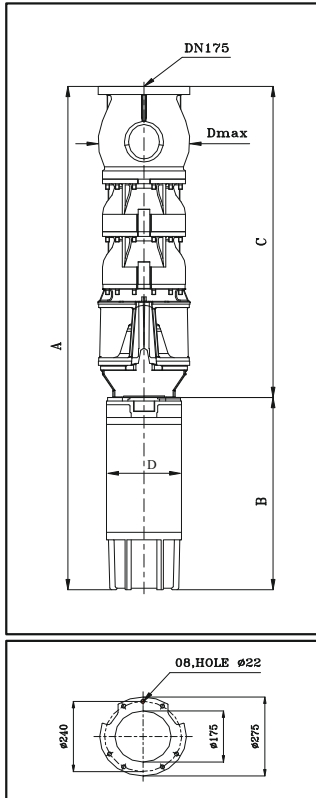

TECHNICAL DATA SSP-300

PUMP TYPE	MOTOR		DIMENSIONS (MM)				NET WEIGHT (KG) PUMPS SET
	TYPE	POWER (kW)	C	B	A	D	
SSP300-1N	MATSF8"	22	885	1140	2025	194	266
SSP300-1L	MATSF8"	30	885	1140	2025	194	286
SSP300-1D	MATSF8"	37	885	1140	2025	194	296
SSP300-1A	MATSF8"	45	885	1230	2115	194	317
SSP300-2L	MATSF8"	55	1065	1340	2405	194	357
SSP300-2F	MATSF8"	63	1065	1470	2535	194	383
SSP300-2D	MATSF8"	75	1065	1560	2625	194	402
SSP300-3L	MATSF8"	75	1245	1560	2805	194	427
SSP300-3F	MATSF8"	93	1245	1740	2985	194	473
SSP300-3D	MATSF10"	110	1245	1529	2774	235	580
SSP300-3A	MATSF10"	130	1245	1659	2904	235	630
SSP300-4G	MATSF10"	130	1425	1659	3084	235	655
SSP300-4F	MATSF10"	132	1425	1659	3084	235	655
SSP300-4D	MATSF10"	150	1425	1769	3194	235	720
SSP300-5G	MATSF10"	150	1605	1769	3374	235	745
SSP300-5F	MATSF10"	170	1605	1919	3524	235	865
SSP300-5D	MATSF10"	185	1605	1919	3524	235	910
SSP300-6F	MATSF10"	185	1785	1919	3704	235	935
SSP300-6D	MATSF12"	220	1785	1893	3678	286	985
SSP300-6A	MATSF12"	250	1785	1893	3678	286	1060
SSP300-7D	MATSF12"	250	1965	1893	3858	286	1085

Dmax (6",8",10" and 12"):290mm

PERFORMANCE TABLE SSP 300

SSP 300					DISCHARGE (Q)											
					m ³ /h		0	40	80	120	160	200	240	280	320	360
					l/min.		0	668	1336	2004	2672	3340	4008	4676	5344	6012
MODEL	MATERIAL				MOTOR RATING		TOTAL HEAD IN (m)									
	6" joining	8" joining	10" joining	12" joining	[kW]	[HP]	37	34	32	29	28	26	23	21	16	10
SSP300-1 N	9000010977	-	-	-	26	35	37	34	32	29	28	26	23	21	16	10
SSP300-1L	9000010978	-	-	-	30	40	38	35	33	30	29	27	24	22	17	11
SSP300-1D	9000014266	-	-	-	37	50	48	46	44	41	39	36	34	31	28	24
SSP300-1A	-	9000010980	-	-	45	60	49	48	46	44	41	38	36	33	30	26
SSP300-2L	-	9000010981	-	-	55	75	80	76	71	66	62	58	54	49	41	31
SSP300-2F	-	9000010982	-	-	63	85	92	89	84	78	73	68	64	59	53	45
SSP300-2D	-	9000010983	-	-	75	100	93	90	85	79	74	69	65	60	54	46
SSP300-3L	-	9000010984	-	-	75	100	119	114	106	98	93	87	81	72	62	47
SSP300-3F	-	9000010985	-	-	93	125	138	134	126	118	110	103	96	89	80	68
SSP300-3D	-	-	9000010986	-	110	150	145	140	133	125	117	109	103	99	87	76
SSP300-3A	-	-	9000013929	-	132	177	149	146	140	131	123	115	108	102	95	85
SSP300-4G	-	-	9000010988	-	132	177	173	165	155	146	137	128	119	109	96	79
SSP300-4F	-	-	9000010989	-	132	177	185	179	168	157	147	138	129	120	108	92
SSP300-4D	-	-	9000010990	-	147	197	193	187	178	167	156	146	137	128	118	102
SSP300-5G	-	-	9000010991	-	147	197	216	204	193	181	170	159	148	135	120	98
SSP300-5F	-	-	9000010992	-	170	252	231	224	211	197	184	172	162	150	135	116
SSP300-5D	-	-	9000010993	-	185	252	242	234	222	209	195	183	172	161	148	136
SSP300-6F	-	-	9000010994	-	185	252	276	268	252	236	230	206	194	180	162	139
SSP300-6D	-	-	-	9000010995	220	295	290	280	266	250	234	219	206	193	177	156
SSP300-6A	-	-	-	9000010996	250	335	297	292	279	263	245	230	217	206	192	171
SSP300-7D	-	-	-	9000010997	250	335	337	327	310	291	272	256	240	224	206	182

This Performance Table is Approximate as a Performance Curve
Technical Change without notice

PERFORMANCE CURVE



SUBMERSIBLE PUMP SSP-300

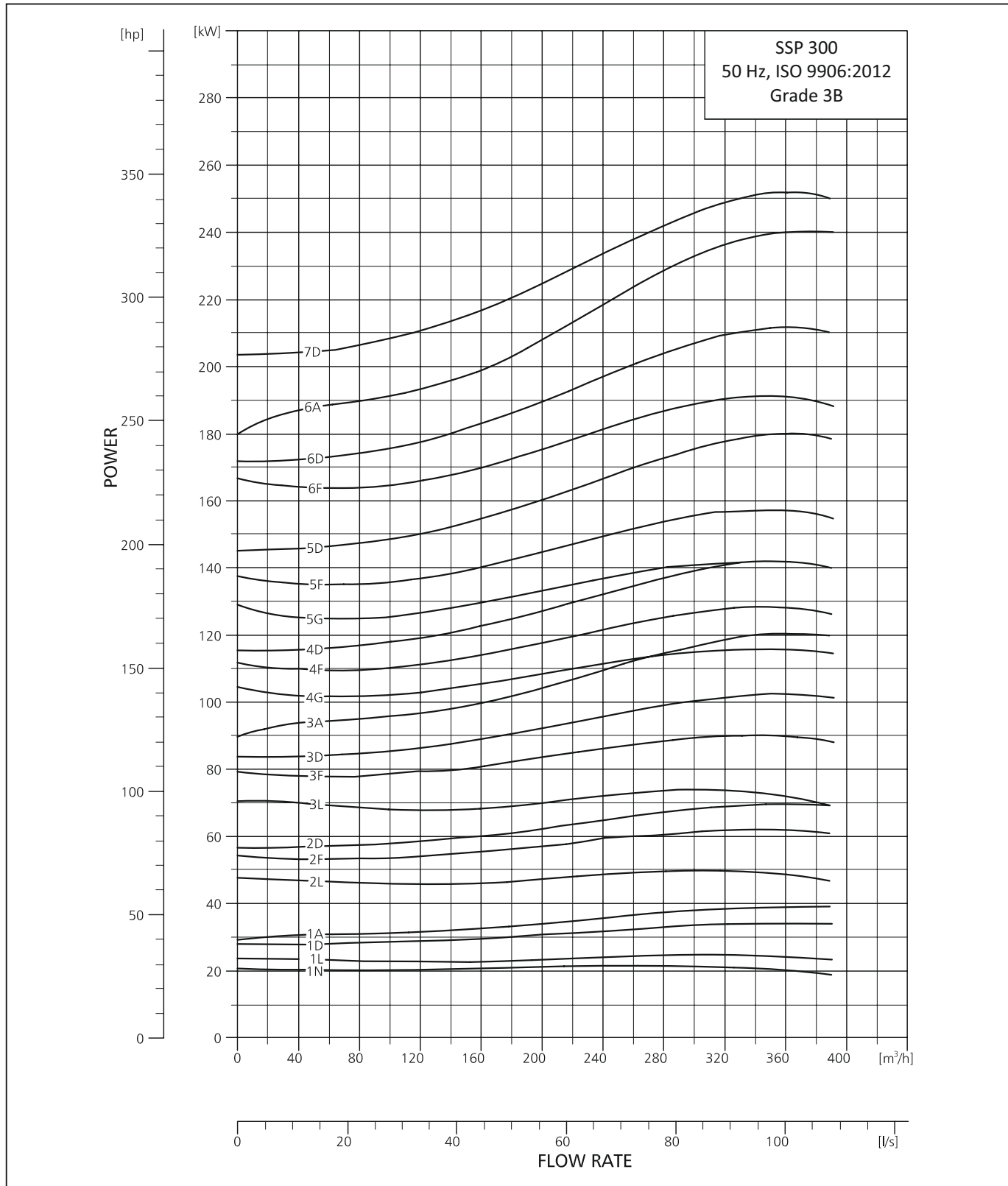

PERFORMANCE CURVE



SUBMERSIBLE PUMP SSP-360

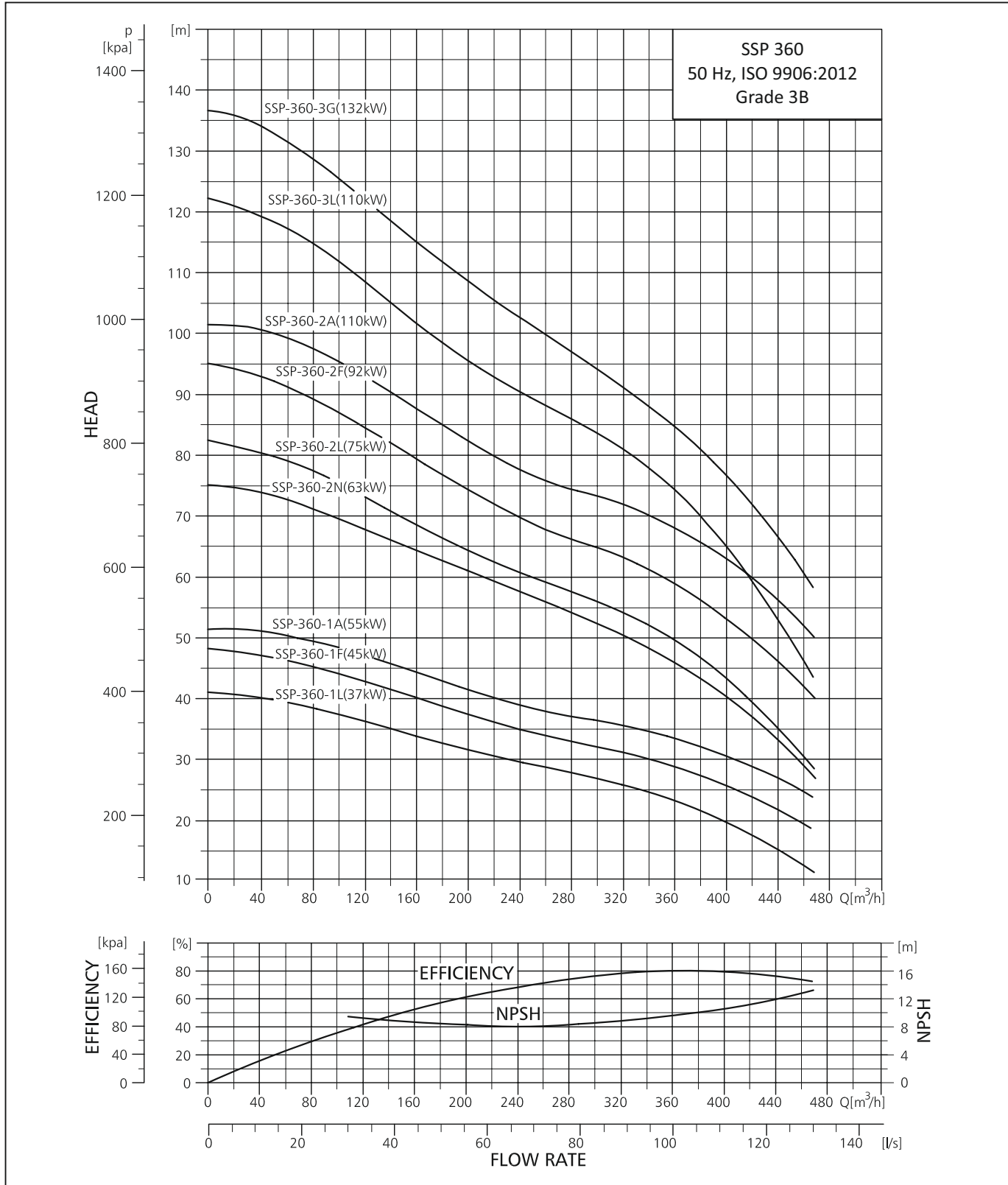

PERFORMANCE CURVE



SUBMERSIBLE PUMP SSP-360

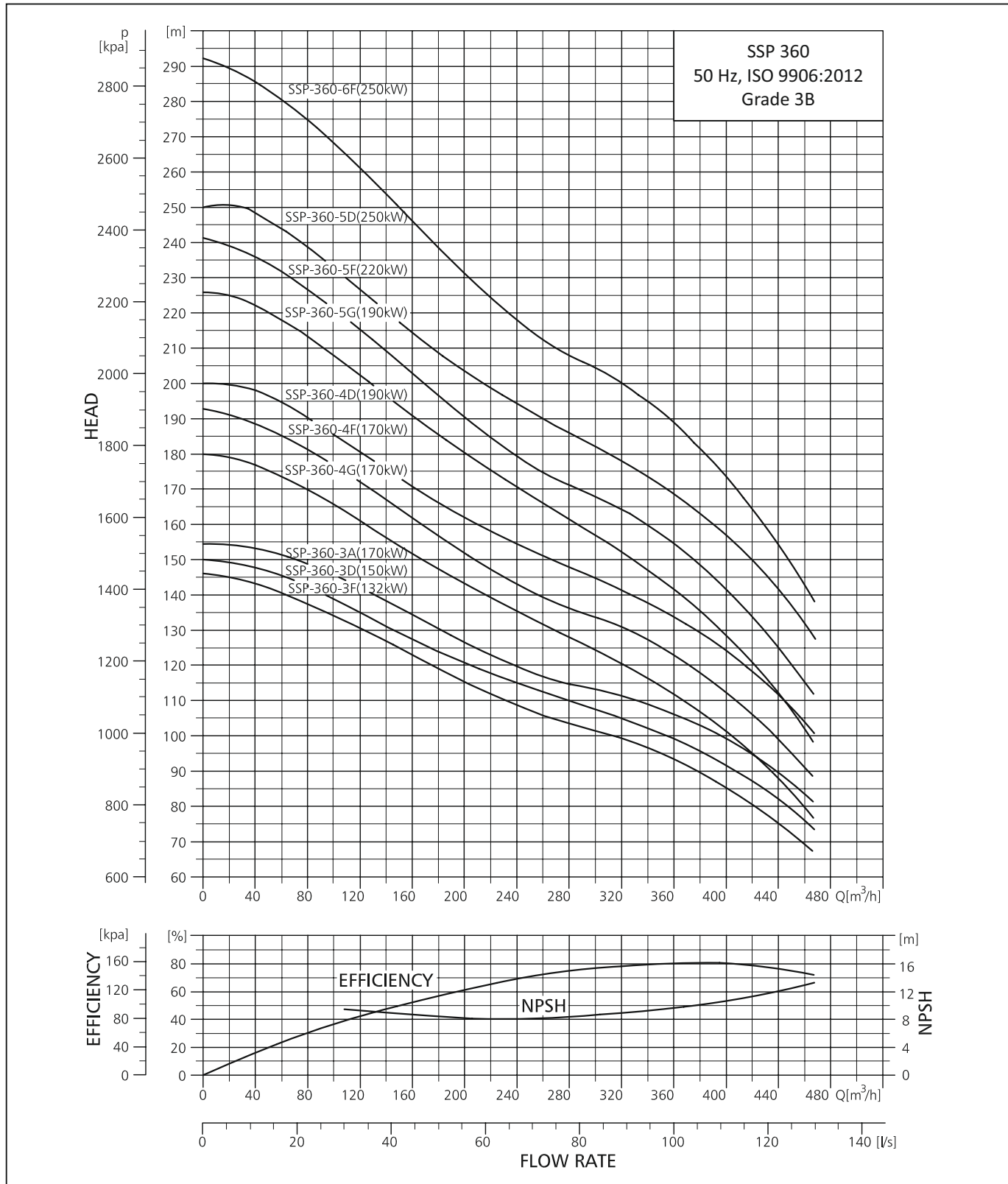

SUBMERSIBLE PUMP SSP-360

DIMENSIONS AND WEIGHTS

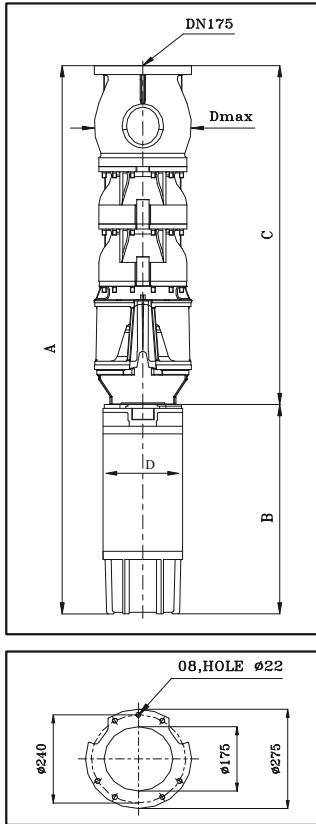

TECHNICAL DATA SSP-360

PUMP TYPE	MOTOR		DIMENSIONS (MM)				NET WEIGHT (KG)
	TYPE	POWER (kW)	C	B	A	D	
SSP360-1L	MATSF8"	37	885	1140	2025	194	296
SSP360-1F	MATSF8"	45	885	1230	2115	194	317
SSP360-1A	MATSF8"	55	885	1340	2225	194	332
SSP360-2N	MATSF8"	63	1065	1470	2535	194	383
SSP360-2L	MATSF8"	75	1065	1560	2625	194	402
SSP360-2F	MATSF8"	93	1065	1740	2805	194	448
SSP360-3L	MATSF10"	110	1245	1529	2774	194	523
SSP360-2A	MATSF10"	110	1065	1529	2594	235	555
SSP360-3L	MATSF10"	110	1245	1529	2774	235	580
SSP360-3G	MATSF10"	130	1245	1659	2904	235	630
SSP360-3F	MATSF10"	130	1245	1659	2904	235	630
SSP360-3D	MATSF10"	150	1245	1769	3014	235	695
SSP360-3A	MATSF10"	150	1245	1769	3014	235	805
SSP360-4G	MATSF10"	170	1425	1919	3344	235	840
SSP360-4F	MATSF10"	170	1425	1919	3344	235	840
SSP360-4D	MATSF10"	185	1425	1919	3344	235	885
SSP360-5G	MATSF10"	185	1605	1919	3524	235	910
SSP360-5F	MOTOR12"	220	1605	1893	3498	286	960
SSP360-5D	MOTOR12"	250	1605	1893	3498	286	1035
SSP360-6F	MOTOR12"	250	1785	1893	3678	286	1060

Dmax (6",8",10" and 12") :290mm

PERFORMANCE TABLE SSP 360

SSP 360		DISCHARGE (Q)																		
		m ³ /h	0	40	80	120	160	200	240	280	320	360	400	440						
		l/min.	0	668	1336	2004	2672	3340	4008	4676	5344	6012	6680	7348						
MODEL	MATERIAL				MOTOR RATING		TOTAL HEAD IN (m)													
	6" joining	8" joining	10" joining	12" joining	[kW]	[HP]	41	39	38	36	34	31	30	28	26	23	20	15		
SSP360-1L	9000010998	-	-	-	37	50	41	39	38	36	34	31	30	28	26	23	20	15		
SSP360-1F	-	9000010999	-	-	45	60	47	47	45	42	39	37	35	33	31	28	25	21		
SSP360-1A	-	9000011000	-	-	55	75	51	50	48	47	44	41	38	37	35	33	30	26		
SSP360-2N	-	9000011001	-	-	63	85	74	73	70	67	63	59	56	52	47	42	36	28		
SSP360-2L	-	9000011002	-	-	75	100	82	79	76	73	69	64	60	57	54	49	43	34		
SSP360-2F	-	9000011003	-	-	93	125	96	95	90	85	79	74	70	67	63	59	54	47		
SSP360-2A	-	-	9000011004	-	110	150	102	101	98	93	88	83	78	75	72	68	64	57		
SSP360-3L	-	-	9000011005	-	110	150	123	119	115	109	103	97	91	86	82	75	66	53		
SSP360-3G	-	-	9000011006	-	132	177	133	131	126	119	112	106	100	94	88	82	74	63		
SSP360-3F	-	-	9000011007	-	132	177	143	141	135	127	119	112	106	101	96	70	82	72		
SSP360-3D	-	-	9000011008	-	147	197	147	146	140	132	124	118	113	108	103	97	89	79		
SSP360-3A	-	-	9000011009	-	147	197	153	152	147	140	132	124	118	113	109	104	97	87		
SSP360-4G	-	-	9000011010	-	170	230	178	174	167	159	150	141	133	126	118	110	99	85		
SSP360-4F	-	-	9000011011	-	170	230	190	188	180	169	158	149	141	135	128	120	110	96		
SSP360-4D	-	-	9000011012	-	185	252	196	194	186	176	167	158	150	144	137	130	120	107		
SSP360-5G	-	-	9000011013	-	185	252	221	217	208	197	186	175	166	157	147	137	123	106		
SSP360-5F	-	-	-	9000011014	220	295	238	236	225	212	198	187	177	169	161	151	139	122		
SSP360-5D	-	-	-	9000011015	250	335	246	243	233	221	209	198	189	181	173	163	150	134		
SSP360-6F	-	-	-	9000011016	250	335	286	282	270	253	237	223	212	202	193	182	166	147		

This Performance Table is Approximate as a Performance Curve
 Technical Change without notice

PERFORMANCE CURVE



SUBMERSIBLE PUMP SSP-360

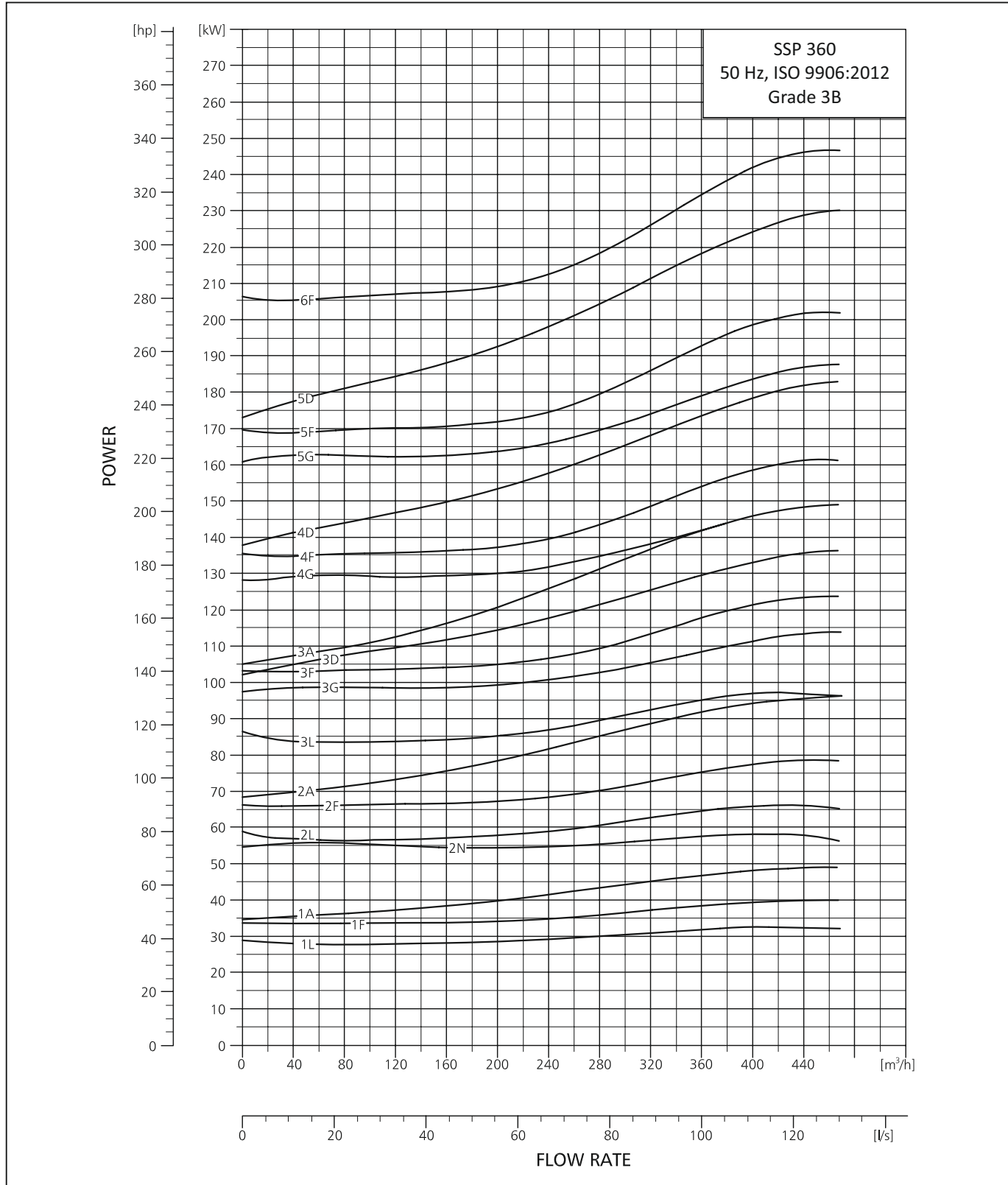

SUBMERSIBLE MOTORS



SINGLE PHASE PERFORMANCE DATA 50 HZ

SINGLE PHASE MOTOR SPECIFICATION (50 HZ) 4" PREMIUM 100

RATING					FULL LOAD WATTS	LINE TO LINE (1) RESISTANCE (OHMS)		EFFICIENCY %			POWER FACTOR %			LOCKED ROTOR AMPS	CIRCUIT BREAKERS OR FUSE AMPS TYPICAL SUBMERSIBLE	
[HP]	[KW]	VOLTS	LINE VOLTS	AMPS		MAIN	START	100	75	50	100	75	50		NONTIME DELAY (STD) FUSE OR CIRCUIT BREAKER	DUEL ELEMENT TIME DELAY FUSE
0.5	0.37	230	230	2.8	601	7.5	10.73	62	60	58	0.91	0.89	0.87	11.2	15.0	4.5
0.75	0.55	230	230	3.8	828	6.66	6.85	68	66	64	0.95	0.93	0.91	15.2	15.0	7.0
1.0	0.75	230	230	4.9	1096	4.57	9.38	69	66	64	0.96	0.94	0.92	19.6	20.0	9.0
1.5	1.1	230	230	7.5	1590	3.1	11.3	70	68	66	0.92	0.90	0.88	30.0	20.0	12.0
2.0	1.5	230	230	10.3	2136	2.03	8.08	72	70	68	0.9	0.88	0.86	41.2	30.0	15.0
3.0	2.2	230	230	14.5	3296	1.57	3.84	67	65	63	0.98	0.96	0.94	58	50.0	25.0
5.0	3.7	230	230	22.3	5239	1.19	2.31	73	71	69	0.98	0.96	0.94	89.2	70.0	30.0

*PERFORMANCE IS TYPICALLY GUARANTEED

- (1) Main winding - yellow to black
Start winding - yellow to red

SUBMERSIBLE MOTORS



THREE PHASE PERFORMANCE DATA 50 HZ

THREE PHASE MOTOR SPECIFICATION (50 HZ) 4" PREMIUM 100

RATING				FULL LOAD WATT	LINE TO LINE (1) RESITANCE (OHMS)	EFFICIENCY	POWER	LOCKED ROTOR AMPS	CIRCUIT BREAKERS OR FUSE AMPS TYPICAL SUBMERSIABLE	
[HP]	[KW]	VOLTS	AMPS			%	FACTOR %		NONTIME DELAY (STD) FUSE OR CIRCUIT BREAK	DUEL ELEMNT TIME DELAY FUSE
						F.I.	F.I.			
0.5	0.37	380	1.1	580	34-1-35.8	65	0.75	4.4	15	1.2
		400	1.1	600		66	0.75	4.4		
		415	1.1	624		67	0.75	4.4		
0.75	0.55	380	1.5	816	34-1-35.8	68	0.86	6.0	15	1.8
		400	1.4	824		68	0.84	5.6		
		415	1.4	832		69	0.82	5.6		
1.0	0.75	380	2.2	1050	15.83-16.62	73	0.72	8.8	15	2.5
		400	2.3	1080		72	0.68	9.2		
		415	2.3	1104		72	0.65	9.2		
1.5	1.1	380	3.1	1536	12.75-13.38	75	0.83	12.4	15	3
		400	2.7	1584		76	0.83	10.8		
		415	2.7	1608		76	0.81	10.8		
2.0	1.5	380	3.6	2040	8.18-8.58	74	0.76	14.4	15	4.5
		400	4.1	2088		74	0.74	16.4		
		415	4.1	2112		74	0.71	16.4		
3.0	2.2	380	5.7	2956	4.12-4.32	76	0.73	22.8	15	7
		400	6.3	3024		76	0.69	25.2		
		415	6.5	3072		75	0.66	26.0		
4.0	3.0	380	8.0	4056	3.37-3.53	76	0.77	32.0	20	9
		400	8.1	4104		75	0.73	32.4		
		415	8.4	4176		75	0.69	33.6		
5.0	3.7	380	9.0	4896	2.57-2.69	76	0.74	36.0	25	10
		400	10.2	4944		76	0.70	40.8		
		415	10.7	5088		74	0.66	42.8		
5.5	4.0	380	10.0	5275	2.66-2.79	77	0.76	40.0	25	12
		400	10.4	5208		76	0.72	41.6		
		415	10.6	5222		76	0.68	42.4		
7.5	5.5	380	13.0	7194	2.29-2.40	76	0.81	52.0	35	15
		400	13.4	7324		76	0.79	53.6		
		415	13.5	7428		76	0.76	54.0		
10.0	7.5	380	19.0	9812	1.82-1.91	77	0.83	76.0	50	25
		400	18	9960		77	0.80	72.0		
		415	18.3	10128		77	0.77	73.2		

*PERFORMANCE IS TYPICALLY GUARANTEED

SUBMERSIBLE MOTORS



MTSF 6” REWINDABLE MOTORS PERFORMANCE DATA 50 HZ

MTSF 6” REWINDABLE MOTORS PERFORMANCE DATA 50 HZ

Material Code	[HP]	[kW]	Thrust F[N]	U _N	n _N	I _N	I _A	EFFICIENCY [%]			POWER FACTOR [%]			T _N	T _A
				[V]	[min ⁻¹]	[A]	[A]	50	75	100	50	75	100	[Nm]	[Nm]
9000006071	5.5	4.0	15500	380	2872	10.3	46	65	72	75	0.63	0.77	0.80	13.3	17.3
				400	2884	10.3	46	64	71	75	0.61	0.74	0.77	13.2	17.2
				415	2892	10.5	47	63	71	74	0.58	0.71	0.73	13.2	17.2
9000006072	7.5	5.5	15500	380	2856	13.7	62	75	78	78	0.69	0.80	0.84	18.4	23.9
				400	2872	12.7	57	74	77	78	0.66	0.77	0.81	18.3	23.8
				415	2880	12.6	57	72	76	78	0.64	0.74	0.79	18.2	23.7
9000006073	10.0	7.5	15500	380	2872	18.0	81	69	74	76	0.69	0.81	0.84	24.9	32.4
				400	2888	17.9	81	66	73	75	0.66	0.78	0.81	24.8	32.2
				415	2896	18.1	81	64	71	74	0.64	0.75	0.79	24.7	32.1
9000006074	12.5	9.3	15500	380	2796	22.4	101	75	77	78	0.60	0.74	0.81	31.7	41.3
				400	2802	22.0	103	74	76	78	0.58	0.70	0.80	31.7	41.2
				415	2826	22.2	104	73	75	78	0.57	0.68	0.77	31.4	40.8
9000006075	15.0	11.0	15500	380	2846	25.7	121	75	77	79	0.67	0.80	0.83	36.9	49.8
				400	2858	25.3	119	73	76	78	0.64	0.77	0.81	36.7	49.6
				415	2872	25.4	119	72	75	78	0.62	0.75	0.79	36.6	49.4
9000006076	17.5	13.0	15500	380	2840	28.5	134	76	78	79	0.78	0.81	0.88	43.7	59.0
				400	2848	27.9	131	75	77	79	0.75	0.78	0.85	43.6	58.8
				415	2860	27.6	130	75	76	79	0.75	0.77	0.84	43.4	58.6
9000006077	20.0	15.0	15500	380	2852	33.2	159	79	80	81	0.71	0.76	0.85	50.2	67.8
				400	2864	31.9	153	78	79	81	0.70	0.75	0.84	50.0	67.5
				415	2872	32.0	154	77	78	81	0.70	0.74	0.82	49.9	69.8
9000006078	25	18.5	15500	380	2844	40.8	196	78	79	81	0.70	0.79	0.85	62.1	86.9
				400	2862	40.2	193	77	79	81	0.70	0.78	0.83	61.7	86.4
				415	2876	40.4	194	78	79	81	0.71	0.77	0.81	61.4	86.0
9000006079	30	22.0	15500	380	2860	48.7	234	80	81	82	0.70	0.77	0.84	73.4	102.8
				400	2872	48.9	235	80	81	82	0.70	0.77	0.80	73.1	102.4
				415	2880	49.3	242	80	80	81	0.70	0.76	0.78	72.9	102.1
9000006080	35	26.0	15500	380	2860	58.5	287	79	81	82	0.70	0.74	0.82	86.8	121.5
				400	2876	58.6	287	80	81	82	0.71	0.74	0.79	86.3	120.8
				415	2880	59.5	292	79	81	82	0.70	0.73	0.76	86.2	120.6
9000006081	40	30.0	15500	380	2864	64.5	316	82	83	84	0.70	0.77	0.84	100.0	140.0
				400	2876	64.2	315	81	82	84	0.69	0.76	0.81	99.6	139.4
				415	2880	64.7	317	80	81	83	0.69	0.75	0.78	99.4	139.2
9000006082	50.0	37.0	15500	380	2868	79.3	389	80	82	83	0.75	0.80	0.86	123.1	172.4
				400	2874	79.5	390	80	81	83	0.71	0.77	0.82	122.9	172.0
				415	2880	80.0	392	79	80	82	0.70	0.75	0.79	122.6	171.7

*PERFORMANCE IS TYPICALLY GUARANTEED

SUBMERSIBLE MOTORS



MTSF 8" REWINDABLE MOTORS PERFORMANCE DATA 50 HZ

MTSF 8" REWINDABLE MOTORS PERFORMANCE DATA 50 HZ

MATERIAL CODE	PN	Thrust	U _N	n _N	I _N	I _A	EFFICIENCY[%]			POWER FACTOR [%]			T _N	T _A
	[kW]	F[N]	[V]	[min ⁻¹]	[A]	[A]	50	75	100	50	75	100	[Nm]	[Nm]
9000012053	22	45000	380	2856	46.8	187	81	84	84	0.76	0.83	0.86	74	94
			400	2872	45.5	182	81	84	84	0.72	0.81	0.84	73	104
			415	2880	45	180	80	84	84	0.69	0.79	0.82	73	112
9000006583	30	45000	380	2880	65.6	262	83	84	84	0.80	0.81	0.82	100	127
			400	2888	64.8	259	83	84	84	0.76	0.77	0.79	99	141
			415	2892	64.8	259	83	84	84	0.75	0.76	0.77	99	153
9000006584	37	45000	380	2848	79	324	83	83	84	0.78	0.80	0.83	124	159
			400	2864	78.0	312	83	84	84	0.76	0.79	0.82	123	158
			415	2868	77.6	310	83	84	84	0.75	0.78	0.80	123	194
9000006585	45	45000	380	2844	93.5	374	82	85	84	0.75	0.84	0.87	151	221
			400	2856	90.3	361	83	85	85	0.72	0.83	0.87	151	245
			415	2872	89.0	356	81	85	85	0.65	0.82	0.85	150	266
9000006586	52	45000	380	2872	104.0	416	86	87	87	0.87	0.87	0.88	173	281
			400	2888	103.1	412	86	87	87	0.83	0.84	0.84	172	314
			415	2892	101.2	405	86	87	87	0.83	0.82	0.83	172	309
9000006587	55	45000	380	2860	111.1	444	87	87	86	0.86	0.86	0.88	184	304
			400	2872	105.4	422	87	87	87	0.83	0.83	0.89	183	344
			415	2884	106.4	426	87	87	87	0.84	0.81	0.86	182	368
9000006606	60	45000	380	2876	121	484	86	87	87	0.73	0.81	0.87	199	321
			400	2900	119	476	85	87	87	0.69	0.79	0.85	198	358
			415	2904	117	468	85	87	88	0.66	0.76	0.83	197	358
9000006589	63	45000	380	2868	125.5	502	87	88	87	0.79	0.88	0.88	210	339
			400	2892	121.0	484	86	88	87	0.76	0.85	0.87	208	377
			415	2896	120.0	480	86	88	88	0.72	0.84	0.86	208	374
9000011072	67	45000	380	2868	138.5	552	85	85	86	0.77	0.83	0.86	223	357
			400	2872	134	532	84	85	86	0.72	0.80	0.85	226	459
			415	2876	132	524	84	85	86	0.69	0.79	0.84	225	402
9000006590	75	45000	380	2876	155.0	620	85	86	86	0.80	0.83	0.85	249	423
			400	2884	152.0	608	85	86	86	0.79	0.82	0.84	248	517
			415	2888	150.0	600	85	86	86	0.78	0.80	0.82	248	476
9000006591	83	45000	380	2892	178	712	83	84	87	0.68	0.77	0.82	274	482
			400	2896	177	708	83	84	86	0.63	0.69	0.78	274	546
			415	2900	178	712	82	84	86	0.57	0.67	0.75	274	588
9000006592	93	45000	380	2880	192.0	768	85	87	86	0.85	0.85	0.85	309	562
			400	2888	191.0	764	85	86	86	0.82	0.82	0.82	307	680
			415	2892	192.2	769	84	86	86	0.80	0.80	0.80	306	679

*PERFORMANCE IS TYPICALLY GUARANTEED

SUBMERSIBLE MOTORS



MTSF 10" REWINDABLE MOTORS PERFORMANCE DATA 50 HZ

MTSF 10" REWINDABLE MOTORS PERFORMANCE DATA 50 Hz

MATERIAL CODE	KW	Thrust	Voltage	Speed	I _N	I _A	Efficiency at % Load			Power Factor at % Load			T _N	T _A
							50	75	100	50	75	100		
9000008521	85	60000	380	2890	179	783	84	85	86	0.75	0.76	0.79	284	282
			400	2900	174	828	84	85	86	0.73	0.74	0.78	283	319
			415	2910	171	863	84	85	86	0.71	0.72	0.76	281	344
9000008522	110	60000	380	2872	240	1118	85	86	86	0.76	0.79	0.82	366	424
			400	2888	229	1143	85	86	86	0.74	0.78	0.82	364	472
			415	2896	227	1175	85	86	86	0.72	0.76	0.80	363	511
9000008523	130	60000	380	2860	280	1338	85	86	85	0.80	0.84	0.85	434	433
			400	2876	270	1418	84	85	85	0.77	0.79	0.83	432	555
			415	2880	268	1471	84	85	85	0.74	0.78	0.81	431	601
9000008524	150	60000	380	2880	318	1556	87	87	87	0.77	0.78	0.83	498	573
			400	2896	308	1643	87	87	88	0.75	0.72	0.82	495	643
			415	2900	303	1694	87	87	88	0.75	0.72	0.80	494	696
9000013330	170	60000	380	2900	345	1688	87	87	87	0.86	0.84	0.86	560	645
			400	2904	330	1761	87	88	88	0.87	0.84	0.87	559	726
			415	2912	324	1812	85	87	87	0.87	0.84	0.84	558	786
9000008525	185	60000	380	2900	390	1983	87	88	87	0.85	0.84	0.85	609	914
			400	2920	384	2070	87	88	88	0.83	0.84	0.81	609	1030
			415	2920	389	2076	86	88	86	0.84	0.84	0.79	605	1109

*PERFORMANCE IS TYPICALLY GUARANTEED

SUBMERSIBLE MOTORS



MTSF 12" REWINDABLE MOTORS PERFORMANCE DATA 50 HZ

MTSF 12" REWINDABLE MOTORS PERFORMANCE DATA 50 Hz

KW	Thrust	Voltage	Speed	I _N	I _A /I _N	Efficiency at % Load			Power Factor at % Load			T _N	T _A /T _N
						50	75	100	50	75	100		
185	60000	380	2910	363	4.60	84	85	87	0.85	0.87	0.89	607	0.85
		400	2915	353	5.30	85	86	87	0.82	0.85	0.87	606	0.90
		415	2920	340	5.70	86	87	88	0.81	0.84	0.86	605	0.93
220	60000	380	2939	439	5.03	87	87	88	0.80	0.84	0.86	715	0.75
		400	2944	421	5.04	88	88	89	0.79	0.81	0.85	712	0.83
		415	2949	410	5.05	88	88	89	0.78	0.82	0.84	710	0.94
250	60000	380	2913	504	4.55	87	88	87	0.81	0.84	0.87	820	0.86
		400	2918	482	4.56	88	87	88	0.80	0.82	0.85	818	0.97
		415	2923	471	4.57	87	87	88	0.79	0.82	0.84	816	1.03
300	60000	380	2932	591	4.66	87	88	89	0.80	0.83	0.87	977	0.83
		400	2937	566	4.67	88	88	89	0.81	0.85	0.86	975	0.92
		415	2942	552	4.68	87	87	89	0.78	0.82	0.85	972	1.01
350	60000	380	2931	692	4.56	88	87	88	0.81	0.88	0.87	1141	0.82
		400	2937	671	4.57	88	88	89	0.82	0.86	0.85	1139	0.93
		415	2941	653	4.57	87	88	89	0.81	0.82	0.84	1137	0.94
400	60000	380	2925	776	4.24	89	90	90	0.80	0.85	0.87	1306	0.75
		400	2930	737	4.25	89	90	90	0.82	0.86	0.87	1305	0.86
		415	2935	711	4.25	90	90	90	0.82	0.84	0.87	1303	0.94

*PERFORMANCE IS TYPICALLY GUARANTEED

TABLE OF HEAD LOSSES

CONNECTING PIECES

The tables below show the range of connecting pieces for connection of thread-to-flange and thread-to-thread.

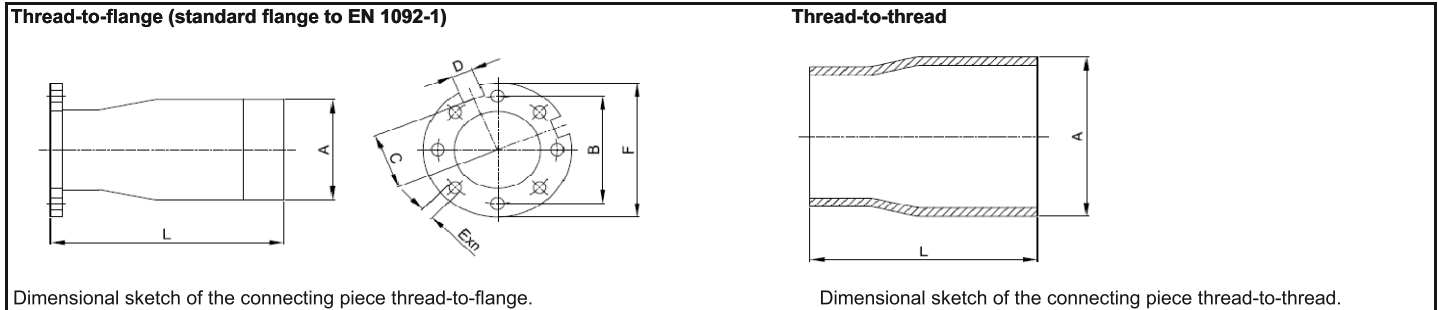

Dimensional sketch of the connecting piece thread-to-flange.

Dimensional sketch of the connecting piece thread-to-thread.

Type	Pump outlet	Connecting piece	A	Dimensions [mm]						v1	v2	n
				B	C	D	E	F	L			
QF-30	Rp 2 1/2	R 2 1/2 → DN 50 PN 16/40	R 2 1/2	125	65	40	∅19	∅165	170	60	90	4
		R 2 1/2 → DN 65 PN 16/40	R 2 1/2	145	71	30	∅19	∅185	170	22.5	45	8
		R 2 1/2 → DN 80 PN 16/40	R 2 1/2	160	82.5	40	∅19	∅200	170	22.5	45	8
QF-50	Rp 3	R 3 → DN 65 PN 16/40	R 3	145	71	30	∅19	∅185	170	22.5	45	8
		R 3 → DN 80 PN 16/40	R 3	160	82.5	40	∅19	∅200	170	22.5	45	8
		R 3 → DN 100 PN 16/40	R 3	180/190	100	40	∅19/∅23	∅235	170	22.5	45	8
QF-75 QF-100	Rp 3 Rp 4	R 3 → DN 65 PN 16/40	R 3	145	71	30	∅19	∅185	170	22.5	45	8
		R 3 → DN 80 PN 16/40	R 3	160	82.5	40	∅19	∅200	170	22.5	45	8
		R 3 → DN 100 PN 16/40	R 3	180/190	100	40	∅19/∅23	∅235	170	22.5	45	8
		R 4 → DN 100 PN 16/40	R 4	180/190	100	40	∅19/∅23	∅235	180	22.5	45	8
QF-125 QF-160	Rp 5	R 5 → DN 100 PN 16/40	R 5	180/190	82	35	∅19/∅23	∅235	195	22.5	45	8
		R 5 → DN 125 PN 16/40	R 5	210/220	99	37	∅19/∅28	∅270	195	22.5	45	8
		R 5 → DN 150 PN 16/40	R 5	240/250	115	36	∅23/∅28	∅300	195	22.5	45	8
QF-210 QF-270 QF-360	Rp 6	R 6 → DN 125 PN 16/40	R 6	210/220	99	36	∅19/∅28	∅270	195	22.5	45	8
		R 6 → DN 150 PN 16/40	R 6	240/250	114	36	∅23/∅28	∅300	195	22.5	45	8
		R 6 → DN 200 PN 16	R 6	295	134	36	∅23	∅340	195	15	30	12
		R 6 → DN 200 PN 40	R 6	320	151	36	∅31	∅375	200	15	30	12

Type	Pump outlet	Connecting piece	Dimensions		L [mm]
			A	B	
QF-125 QF-160	Rp 5	R 5 → R 4	Rp 5	Rp 4	121
		R 5 → R 6	Rp 5	Rp 6	150
	5" NPT	5" NPT → 4" NPT	5" NPT	4" NPT	121
		5" NPT → 6" NPT	5" NPT	6" NPT	150
QF-210 QF-270 QF-360	Rp 6	R 6 → R 5	Rp 6	Rp 5	150
	6" NPT	6" NPT → 5" NPT	6" NPT	5" NPT	150

TABLE OF HEAD LOSSES

HEAD LOSSES IN ORDINARY WATER PIPES

MISCELLANEOUS

UPPER FIGURES INDICATE THE VELOCITY OF WATER IN M/SEC.

LOWER FIGURES INDICATE HEAD LOSS IN METERS PER 100 METERS OF STRAIGHT PIPES.

Quantity of water			Head losses in ordinary water pipes															
m ³ /h	Litres/min.	Litres/sec.	Nominal pipe diameter in inches and internal diameter in [mm]															
			1/2" 15.75	3/4" 21.25	1" 27.00	1 1/4" 35.75	1 1/2" 41.25	2" 52.50	2 1/2" 68.00	3" 80.25	3 1/2" 92.50	4" 105.0	5" 130.0	6" 155.5				
0.6	10	0.16	0.855 9.910	0.470 2.407	0.292 0.784													
0.9	15	0.25	1.282 20.11	0.705 4.862	0.438 1.570	0.249 0.416												
1.2	20	0.33	1.710 33.53	0.940 8.035	0.584 2.588	0.331 0.677	0.249 0.346											
1.5	25	0.42	2.138 49.93	1.174 11.91	0.730 3.834	0.415 1.004	0.312 0.510											
1.8	30	0.50	2.565 69.34	1.409 16.50	0.876 5.277	0.498 1.379	0.374 0.700	0.231 0.223										
2.1	35	0.58	2.993 91.54	1.644 21.75	1.022 6.949	0.581 1.811	0.436 0.914	0.269 0.291										
2.4	40	0.67		1.879 27.66	1.168 8.820	0.664 2.290	0.499 1.160	0.308 0.368										
3.0	50	0.83		2.349 41.40	1.460 13.14	0.830 3.403	0.623 1.719	0.385 0.544	0.229 0.159									
3.6	60	1.00		2.819 57.74	1.751 18.28	0.996 4.718	0.748 2.375	0.462 0.751	0.275 0.218									
4.2	70	1.12		3.288 76.49	2.043 24.18	1.162 6.231	0.873 3.132	0.539 0.988	0.321 0.287	0.231 0.131								
4.8	80	1.33			2.335 30.87	1.328 7.940	0.997 3.988	0.616 1.254	0.367 0.363	0.263 0.164								
5.4	90	1.50			2.627 38.30	1.494 9.828	1.122 4.927	0.693 1.551	0.413 0.449	0.269 0.203								
6.0	100	1.67			2.919 46.49	1.660 11.90	1.247 5.972	0.770 1.875	0.459 0.542	0.329 0.244	0.248 0.124							
7.5	125	2.08			3.649 70.41	2.075 17.93	1.558 8.967	0.962 2.802	0.574 0.809	0.412 0.365	0.310 0.185	0.241 0.101						
9.0	150	2.50				2.490 25.11	1.870 12.53	1.154 3.903	0.668 1.124	0.494 0.506	0.372 0.256	0.289 0.140						
10.5	175	2.92				2.904 33.32	2.182 16.66	1.347 5.179	0.803 1.488	0.576 0.670	0.434 0.338	0.337 0.184						
12	200	3.33				3.319 42.75	2.493 21.36	1.539 6.624	0.918 1.901	0.659 0.855	0.496 0.431	0.385 0.234	0.251 0.084					
15	250	4.17				4.149 64.86	3.117 32.32	1.924 10.03	1.147 2.860	0.823 1.282	0.620 0.646	0.481 0.350	0.314 0.126					
18	300	5.00					3.740 45.52	2.309 14.04	1.377 4.009	0.988 1.792	0.744 0.903	0.577 0.488	0.377 0.175	0.263 0.074				
24	400	6.67					4.987 78.17	3.078 24.04	1.836 6.828	1.317 3.053	0.992 1.530	0.770 0.829	0.502 0.294	0.351 0.124				
30	500	8.33						3.848 36.71	2.295 10.40	1.647 4.622	1.240 2.315	0.962 1.254	0.628 0.445	0.439 0.187				
36	600	10.0						4.618 51.84	2.753 14.62	1.976 6.505	1.488 3.261	1.155 1.757	0.753 0.623	0.526 0.260				
42	700	11.7							3.212 19.52	2.306 8.693	1.736 4.356	1.347 2.345	0.879 0.831	0.614 0.347				
48	800	13.3							3.671 25.20	2.635 11.18	1.984 5.582	1.540 3.009	1.005 1.066	0.702 0.445				
54	900	15.0							4.130 31.51	2.964 13.97	2.232 6.983	1.732 3.762	1.130 1.328	0.790 0.555				
60	1000	16.7							4.589 38.43	3.294 17.06	2.480 8.521	1.925 4.595	1.256 1.616	0.877 0.674				
75	1250	20.8							4.117 26.10	3.100 13.00	2.406 7.010	1.570 2.458	1.097 1.027					
90	1500	25.0							4.941 36.97	3.720 18.42	2.887 9.892	1.883 3.468	1.316 1.444					
105	1750	29.2								4.340 24.76	3.368 13.30	2.197 4.665	1.535 1.934					
120	2000	33.3								4.960 31.94	3.850 17.16	2.511 5.995	1.754 2.496					
150	2500	41.7									4.812 26.26	3.139 9.216	2.193 3.807					
180	3000	50.0										3.767 13.05	2.632 5.417					
240	4000	66.7											5.023 22.72	3.509 8.926				
300	5000	83.3												4.386 14.42				
90 ° bends, slide valves			1.0	1.0	1.1	1.2	1.3	1.4	1.5	1.6	1.6	1.7	2.0	2.5				
T-pieces, non-return valves			4.0	4.0	4.0	5.0	5.0	5.0	6.0	6.0	6.0	7.0	8.0	9.0				

The table is calculated in accordance with H. Lang's new formula $a = 0.02$ and for a water temperature of 10 °C.
 The head loss in bends, slide valves, T-piece and non-return valves is equivalent to the meters of straight pipes stated in the last two lines of the table.
 To find the head loss in foot valves, multiply the loss in T-pieces by two.

TABLE OF HEAD LOSSES

HEAD LOSSES IN PLASTIC PIPES

MISCELLANEOUS

FIGURES INDICATE HEAD LOSS IN METERS PER 100 METERS OF STRAIGHT PIPES.

Quantity of water			HEAD LOSSES IN WATER PIPES													
			PELM/PEH PN 10													
m3/hr	Ltr./min.	Liters/Sec.	PELM			PEH										
			NOMINAL PIPE SIZE IN MM													
			25	32	40	50	63	75	90	110	125	140	160			
0.6	10	0.16	0.64	0.19	0.06											
0.9	15	0.25	1.35	0.40	0.13	0.04										
1.2	20	0.33	2.31	0.69	0.23	0.07										
1.5	25	0.42	3.49	1.05	0.35	0.11	0.03									
1.8	30	0.50	4.89	1.47	0.49	0.16	0.05									
2.1	35	0.58	6.50	1.95	0.66	0.22	0.07									
2.4	40	0.67	8.33	2.50	0.84	0.28	0.09	0.03								
3	50	0.83	12.59	3.78	1.27	0.43	0.14	0.06								
3.6	60	1.00	17.64	5.30	1.79	0.6	0.19	0.08	0.03							
4.2	70	1.12	23.46	7.06	2.38	0.8	0.26	0.11	0.04							
4.8	80	1.33	30.04	9.03	3.05	1.03	0.33	0.14	0.05							
5.4	90	1.50	37.35	11.23	3.79	1.28	0.41	0.17	0.07	0.02						
6	100	1.67	45.39	13.65	4.61	1.55	0.50	0.21	0.08	0.03						
7.5	125	2.08	68.59	20.63	6.96	2.35	0.76	0.32	0.13	0.05	0.02					
9	150	2.50		28.91	9.76	3.29	1.07	0.45	0.18	0.07	0.03					
10.5	175	2.92		38.46	12.98	4.38	1.42	0.60	0.25	0.09	0.05					
12	200	3.33		49.23	16.62	5.61	1.82	0.78	0.32	0.12	0.06	0.03				
15	250	4.17			25.12	8.48	2.75	1.17	0.48	0.18	0.09	0.05	0.02			
18	300	5.00			35.2	11.88	3.86	1.65	0.68	0.25	0.13	0.07	0.04			
24	400	6.67				20.23	6.57	2.81	1.15	0.43	0.23	0.13	0.07			
30	500	8.33				30.58	9.93	4.25	1.75	0.65	0.35	0.20	0.10			
36	600	10.00				42.85	13.91	5.95	2.45	0.92	0.49	0.28	0.14			
42	700	11.70				56.99	18.51	7.92	3.26	1.22	0.66	0.38	0.19			
48	800	13.30					23.69	10.14	4.17	1.57	0.84	0.48	0.25			
54	900	15.00					29.46	12.61	5.19	1.95	1.05	0.60	0.31			
60	1000	16.70					35.81	15.33	6.31	2.37	1.27	0.73	0.38			
75	1250	20.80						23.16	9.54	3.59	1.92	1.11	0.58			
90	1500	25.00						32.46	13.36	5.03	2.70	1.55	0.81			
105	1750	29.00						43.17	17.78	6.69	3.59	2.07	1.08			
120	2000	33.30							22.76	8.57	4.60	2.65	1.38			
150	2500	41.70							34.39	12.95	6.95	4.00	2.09			
180	3000	50.00							48.19	18.15	9.74	5.61	2.93			
240	4000	66.70								30.91	16.59	9.56	4.99			
300	5000	83.30									25.07	14.44	7.54			

The table is based on a nomogram.
 Roughness: K = 0.01 mm.
 Water temperature: t = 10 °C.

CABLE SIZING



SUBMERSIBLE PUMPS SP A, SP

Cable dimensions at 3 X 400 V, 50 Hz, DOL

Voltage drop: 3%

CABLE DIMENSIONS AT 3 X 400 V, 50 Hz VOLTAGE DROP : 3%																			
Motor	kW	I _n [A]	Cos φ 100 %	Dimensions [mm ²]															
				1.5	2.5	4	6	10	16	25	35	50	70	95	120	150	185	240	300
4"	0.37	1.4	0.64	462	767														
4"	0.55	2.2	0.64	294	488	777													
4"	0.75	2.3	0.72	250	416	662	987												
4"	1.1	3.4	0.72	169	281	448	668												
4"	1.5	4.2	0.75	132	219	348	520	857											
4"	2.2	5.5	0.82	92	153	244	364	602	951										
4"	3	7.85	0.77	69	114	182	271	447	705										
4"	4	9.6	0.8	54	90	143	214	353	557	853									
4"	5.5	13	0.81	39	66	104	156	258	407	624	855								
4"	7.5	18.8	0.78	28	47	75	112	185	291	445	609	841							
6"	4	9.2	0.82	55	91	146	218	359	566	867									
6"	5.5	13.6	0.77	40	66	105	157	258	407	622	850								
6"	7.5	17.6	0.8	29	49	78	117	193	304	465	637	882							
6"	9.3	21.8	0.81	23	39	62	93	154	243	372	510	706	950						
6"	11	24.8	0.83		34	53	80	132	209	320	440	610	823						
6"	13	30	0.81		28	45	68	112	176	270	370	513	690	893					
6"	15	34	0.82			39	59	97	154	236	324	449	604	783	947				
6"	18.5	42	0.81				48	80	126	193	265	366	493	638	770	914			
6"	22	48	0.84				41	67	107	164	225	313	422	549	665	793	927		
6"	26	57	0.84					57	90	138	189	263	355	462	560	667	781	937	
6"	30	66.5	0.83					49	78	119	164	227	307	398	482	574	670	803	926
6"	37	85.5	0.79						63	97	133	183	246	317	382	452	525	624	714
8"	22	48	0.84				41	67	107	164	225	313	422	549	665	793	927		
8"	26	56.5	0.85					57	90	138	189	263	356	464	563	672	787	947	
8"	30	64	0.85					50	79	122	167	233	314	409	497	593	695	836	968
8"	37	78.5	0.85						65	99	136	190	256	334	405	483	567	682	789
8"	45	96.5	0.82						54	83	114	158	213	276	334	396	462	553	636
8"	55	114	0.85							68	94	131	177	230	279	333	390	469	544
8"	63	132	0.83								83	115	155	201	243	289	338	404	466
8"	75	152	0.86								70	97	132	171	208	249	292	353	409
8"	93	186	0.86									79	107	140	170	204	239	288	335
8"	110	224	0.87										89	116	141	169	198	240	279
10"	75	156	0.84								69	96	130	169	205	244	285	343	396
10"	93	194	0.82									79	106	137	166	197	230	275	316
10"	110	228	0.84										89	116	140	167	195	234	271
10"	132	270	0.84											98	118	141	165	198	229
10"	147	315	0.81												103	122	142	169	194
10"	170	365	0.81													105	122	146	168
10"	190	425	0.79														106	125	144
12"	147	305	0.83												105	125	146	175	202
12"	170	345	0.85												92	110	129	155	180
12"	190	390	0.84													98	114	137	158
12"	220	445	0.85														100	120	139
12"	250	505	0.85															106	123
Max. current for cable [A]*				23	30	41	53	74	99	131	162	202	250	301	352	404	461	547	633

*At particularly favourable heat dissipation condition.
 Maximum cable length in meters from motor starter to pump.
 For motors with star delta starting, the cable length can be calculated by multiplying the relevant cable length from above table by $\sqrt{3}$

CABLE SIZING



SUBMERSIBLE PUMPS SP A, SP

Cable dimensions at 3 X 400 V, 50 Hz

Voltage drop: 1%

CABLE DIMENSIONS AT 3 X 400 V, 50 Hz VOLTAGE DROP : 1%																			
MOTOR	KW	In [A]	Cos φ 100%	DIMENSIONS [mm ²]															
				1.5	2.5	4	6	10	16	25	35	50	70	95	120	150	185	240	300
4"	0.37	1.4	0.64	192	318	506	752												
4"	0.55	2.2	0.64	122	203	322	479	783											
4"	0.75	2.3	0.72	104	173	275	409	672											
4"	1.1	3.4	0.72	70	117	186	277	455	712										
4"	1.5	4.2	0.75	55	91	145	215	354	556	844									
4"	2.2	5.5	0.82	38	64	101	151	249	393	599	818								
4"	3	7.85	0.77	29	47	75	112	185	291	442	601	822							
4"	4	9.6	0.8	22	37	59	89	146	230	350	477	656	874						
4"	5.5	13	0.81	16	27	43	65	107	168	256	349	480	641	821	983				
4"	7.5	18.8	0.78		20	31	46	76	120	183	248	340	452	577	687	804	923		
6"	5.5	13.6	0.77	16	27	44	65	107	168	255	347	475	629	801	953				
6"	7.5	17.6	0.8	12	20	32	48	80	125	191	260	358	477	610	728	855	984		
6"	9.3	21.8	0.81		16	26	39	64	100	153	208	287	382	490	586	689	795	935	
6"	11	24.8	0.83		14	22	33	55	86	132	180	248	332	427	512	604	699	826	942
6"	13	30	0.81			19	28	46	73	111	151	208	278	356	426	501	577	680	772
6"	15	34	0.82				24	40	64	97	132	182	244	313	375	441	510	601	684
6"	18.5	42	0.81				20	33	52	79	108	149	198	254	304	358	412	486	551
6"	22	48	0.84					28	44	67	92	127	170	220	264	312	361	428	489
6"	26	57	0.84					24	37	57	78	107	144	185	222	263	304	361	412
6"	30	66.5	0.83						32	49	67	92	124	159	191	225	261	308	351
6"	37	85.5	0.79							40	54	74	99	126	150	176	203	238	269
8"	22	48	0.84					28	44	67	92	127	170	220	264	312	361	428	489
8"	26	56.5	0.85					23	37	57	78	107	144	186	224	265	307	365	418
8"	30	64	0.85						33	50	68	95	127	164	197	234	271	322	369
8"	37	78.5	0.85						27	41	56	77	104	134	161	191	221	263	301
8"	45	96.5	0.82							34	47	64	86	110	132	155	180	212	241
8"	55	114	0.85								38	53	71	92	111	131	152	181	207
8"	63	132	0.83									47	62	80	96	113	131	155	177
8"	75	152	0.86									40	53	69	83	98	114	136	156
8"	93	186	0.86										43	56	68	80	94	111	128
8"	110	224	0.87											47	56	67	78	93	107
10"	75	156	0.84										52	68	81	96	111	132	151
10"	92	194	0.82										43	55	66	77	89	105	120
10"	110	228	0.84											46	56	66	76	90	103
10"	132	270	0.84												47	55	64	76	87
10"	147	315	0.81													48	55	65	74
10"	170	365	0.81															56	63
10"	190	425	0.79															48	54
12"	147	305	0.83													49	57	67	77
12"	170	345	0.85														50	60	68
12"	190	390	0.84															53	60
12"	220	445	0.85																53
12"	250	505	0.85																
MAX. CURRENT FOR CABLE [A]*				18.5	25	34	43	60	80	101	126	153	196	38	276	319	364	430	497

*At Particularly Favorable Heat Dissipation Conditions.

Maximum Cable Length in Meters from Motor Starter to Pump.

ZINC ANODES

APPLICATIONS

Cathodic protection by means of zinc can be used for corrosion protection of QF pumps in chloride-containing liquids, such as brackish water and seawater.

Sacrificial anodes are placed on the outside of the pump and motor as protection against corrosion.

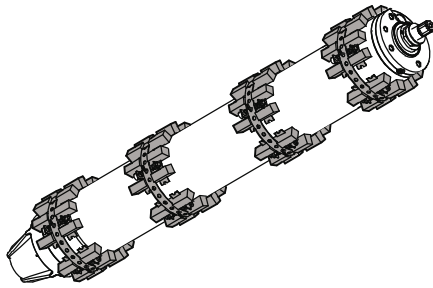

Submersible motor fitted with anode strings

The number of anodes required depends on the pump and motor in question.

FLOW SLEEVES

Shakti Pumps offers a complete range of stainless-steel flow sleeves for both vertical and horizontal operation. Flow sleeves are recommended for all applications in which motor cooling is insufficient. The result is a general extension of motor life. Flow sleeves are to be fitted in these cases:

- If the submersible pump is exposed to high thermal load such as current unbalance, dry running, overload, high ambient temperature and bad cooling conditions.
- If aggressive liquids are pumped, since corrosion is doubled for every 10 °C the temperature rises.
- If sedimentation or deposits occur around and/or on the motor.

See example

Note: More information about flow sleeves is available on request.



Example of calculated flow sleeve

The flow sleeve is fitted to the submersible motor so that the liquid passes close by the motor on its way towards the pump suction interconnector, thus ensuring optimum cooling of the motor. See fig. .

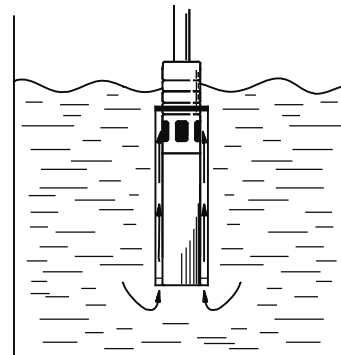

Flow sleeve function

The flow sleeve is designed so that the flow velocity past the motor is minimum 0.5 m/s and maximum 3 m/s to ensure optimum pump operating conditions. Use this formula to calculate flow velocity:

$$V = \frac{Q \times 353}{D^2 - d^2} \text{ [m/s]}$$

Q	m ³ /h	Flow rate
D	mm	Sleeve diameter
d	mm	Pump diameter

